

A TRANSISTORIZED ELECTRONIC "ACCORDION"

5 MAC

RADIO & TV NEWS

World's Leading Electronics Magazine

MAY
1958
35 CENTS

STANDARD TECHNIQUES FOR TESTING FM TUNERS

- NEW TV FRONT END DESIGNS
- BETTER MIKES MAKE BETTER TAPES

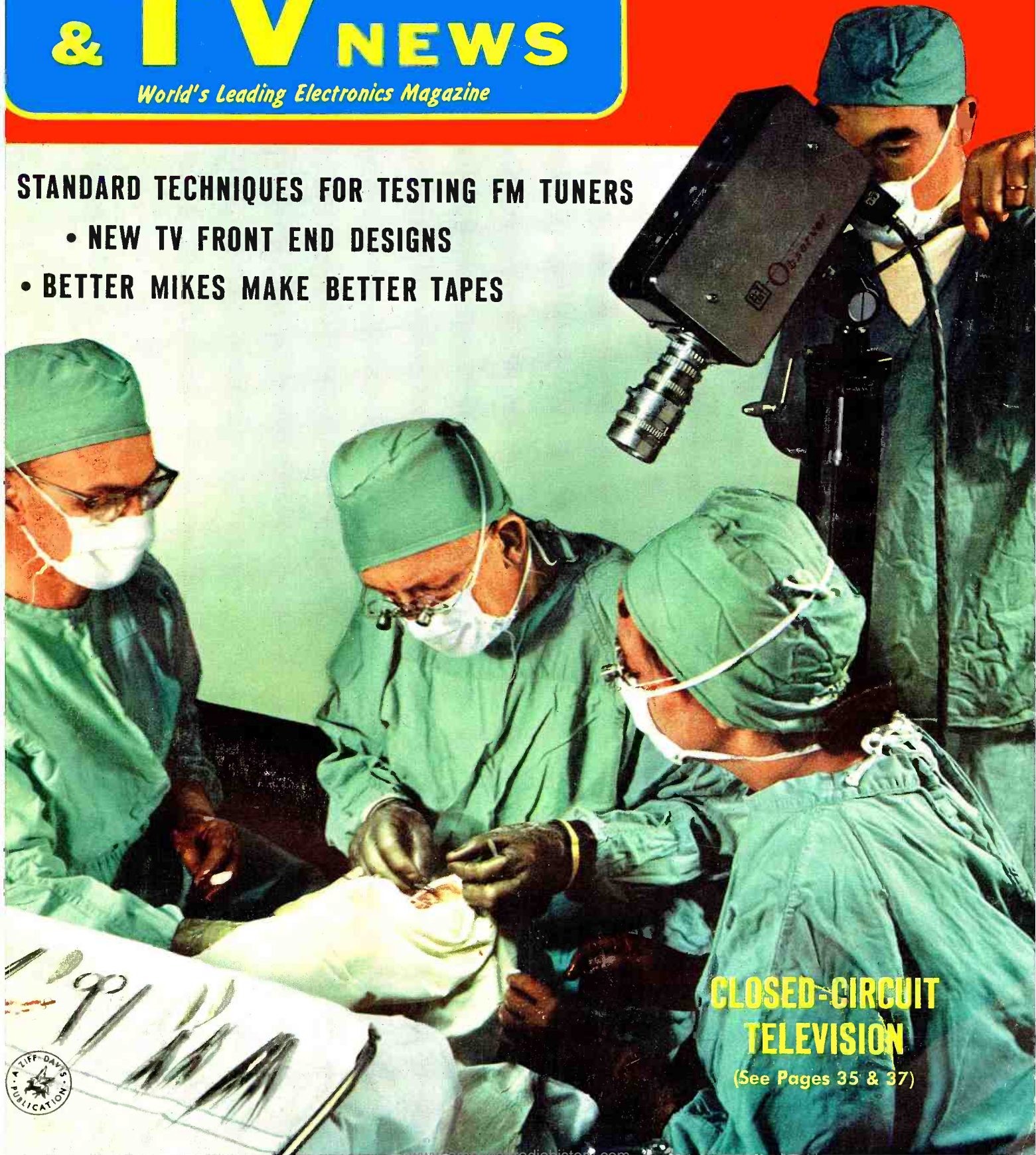

**CLOSED-CIRCUIT
TELEVISION**

(See Pages 35 & 37)



Mr. Independent Service Dealer:



When you buy tubes are you robbing yourself?

Not when you buy Raytheon TV and Radio Tubes

First of all, Raytheon has no factory TV-radio service organization that competes with you for profitable servicing business — you're not helping a "competitor" when you buy Raytheon Tubes.

Then, too, when you buy Raytheon TV and Radio Tubes you get the finest quality tubes money can buy — tubes designed for top performance in all makes and models of receivers. Raytheon does not manufacture sets and therefore must make tubes that will meet the rigid performance requirements of the many sets pro-

duced — tubes ideal for all replacement work.

And last, but by no means least, when you buy Raytheon Tubes you deal with local *independent* tube distributors who are anxious to give you the best in service and technical assistance. They are eager to supply you with the hundreds of helpful shop and sales aids Raytheon makes available for you — helps that make your job easier, more efficient and more profitable.

Make all of your tube dollars work for you — always ask your Tube Distributor for Raytheon quality TV and Radio Tubes.



RAYTHEON MANUFACTURING COMPANY

Receiving Tube and Semiconductor Operations

NEWTON 58, MASS. CHICAGO, ILL. ATLANTA 6, GA. LOS ANGELES 7, CALIF.
55 Chapel Street 9501 Grand Ave. (Franklin Park) 1150 Zonolite Rd. N.E. 2419 So. Grand Ave.

Raytheon makes
all these

Receiving and Picture Tubes, Reliable Subminiature and Miniature Tubes,
Semiconductor Diodes and Transistors, Nucleonic Tubes, Microwave Tubes.



Excellence in Electronics

For a Successful Career in Radio-Television

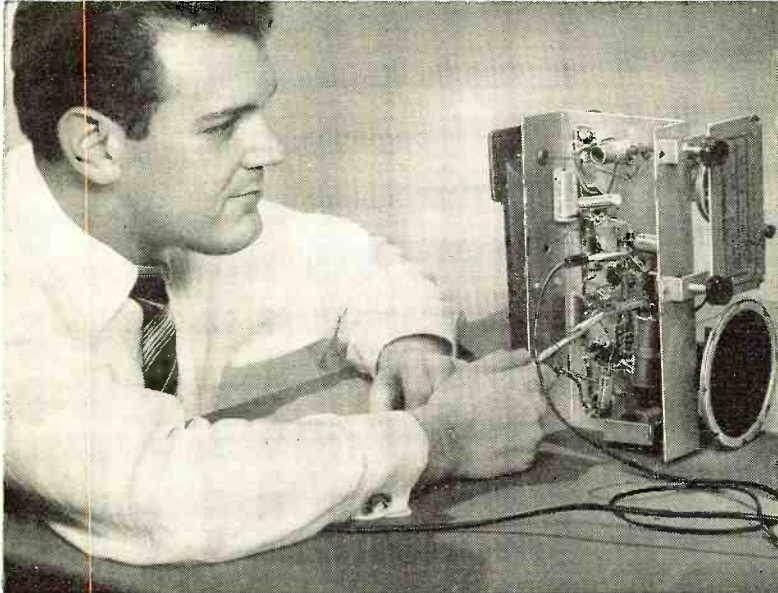

Train at Home in Spare Time with N.R.I.

OLDEST and LARGEST

Home Study Radio-Television School

N.R.I. Trained These Men

ENGINEER STATION WHPE

"Thanks to NRI, I operated a successful Radio repair shop. Now I am an engineer for WHPE." VAN W. WORKMAN, HIGH POINT, NORTH CAROLINA



QUICK SPARE TIME CASH

"Knew nothing about Radio-TV when I enrolled. After 15 lessons started repairing sets. My future looks bright." DONALD B. ACKERMAN, MINNEAPOLIS, MINNESOTA



HAS OWN TV BUSINESS

"Quit my job to do Television work full time. I love it and do all right financially." WILLIAM F. KLINE, CINCINNATI, OHIO



Prosperous Fast Growing Industry Offers You GOOD PAY-BRIGHT FUTURE-SUCCESS

It's the trained man who gets ahead—gets the better job, drives a better car, lives in a better home, is respected for what he knows and can do. For a job with a future—find out how you can train at home for Radio-Television.

TODAY'S OPPORTUNITY FIELD

Training PLUS OPPORTUNITY is the ideal combination for success. And today's OPPORTUNITY field is Radio-Television. Over 125 million home Radios plus 30 million sets in cars, plus 40 million TV sets mean big money for trained Technicians. More than 4,000 Radio and TV broadcasting stations offer interesting and important positions. Color television, portable TV sets, Hi-Fi, assure future growth. Find out about NRI. Since 1914—for more than 40 years—NRI has been training ambitious men

at home in spare time for Radio-TV. With NRI 50-50 method, you study basic principles AND learn by practicing with actual equipment NRI furnishes. You learn with your hands and your head. You get dependable training, backed up by the reputation of the oldest and largest home study Radio-TV school.

ADD TO YOUR INCOME SOON

\$10-\$15 A WEEK IN SPARE TIME

Soon after enrolling many start earning extra money fixing sets. Many open their own full time Radio-TV shops after getting NRI Diploma. MAIL COUPON. Get FREE Sample Lesson and 64-page Catalog showing equipment supplied, outlines of courses, opportunities in Radio-TV. Price is low—terms easy. Address: NATIONAL RADIO INSTITUTE, Dept.

SEE Washington 16, D. C.

You Learn Servicing—Broadcasting at Home—By Practicing with Kits N.R.I. Sends



Nothing takes the place of practical experience. That's why NRI training is Learning-by-Doing. With Servicing Course you build Radio shown at top and other equipment. With Communications Course you build Transmitters at left and other equipment. Catalog shows all equipment you get.

Available To **VETERANS** Under G.I. Bills



SAMPLE LESSON AND CATALOG FREE

MAIL COUPON TODAY

National Radio Institute

Dept. BEE Washington 16, D. C.

Mail me Sample Lesson and 64-Page Catalog FREE. (No salesman will call. Please write plainly.)

Name _____ Age _____

Address _____

City _____ Zone _____ State _____

ACCREDITED MEMBER, NATIONAL HOME STUDY COUNCIL

RADIO & TV NEWS is published monthly by Ziff-Davis Publishing Company, William B. Ziff, Chairman of the Board (1946-1953), at 64 E. Lake Street, Chicago 1, Ill. Entered as second-class matter July 21, 1948, at the Post Office, Chicago, Ill., under the act of March 3, 1879. Authorized by Post Office Department, Ottawa, Canada, as second-class matter. SUBSCRIPTION RATES: one year U. S. and possessions, and Canada \$4.00; Pan American Union Countries \$4.50; all other foreign countries, \$5.00.

RADIO & TV NEWS

Reg. U. S. Pat. Off.

First in radio-television-audio-electronics

Average Net Paid Circulation 246,225

Radio & Television News • Radio News • Television News Trademarks Reg. U. S. Pat. Off.

CONTENTS

MAY, 1958

VOL. 59 ■ NO. 5

Publisher

OLIVER READ, D. Sc., WIETI

Editor

WM. A. STOCKLIN, B. S.

Technical Editor

MILTON S. SNITZER

Service Editor

SIDNEY C. SILVER

Associate Editor

P. B. HOEFER

West Coast Editor

EDWARD A. ALTSHULER

Assistant Editor

J. JUSTER

Television Consultant

WALTER H. BUCHSBAUM

Art Editor

HERBERT ASCHER

Art and Drafting Dept.

**J. A. GOLANEK
JAMES A. ROTH
MILTON WHELPLEY**

Advertising Director

JOHN A. RONAN, JR.

Advertising Manager

MURRAY GOLDMAN

Midwest Adv. Manager

W. ROBERT WOLFE

Western Adv. Manager

JOHN E. PAYNE



ZIFF-DAVIS PUBLISHING COMPANY
William Ziff, President; H. J. Morganroth, Vice-President; W. Bradford Briggs, Vice-President; Michael H. Froelich, Vice-President; Michael Michaelson, Vice-President and Circulation Director; Victor C. Stabile, Treasurer; Hershel B. Sarbin, Secretary; Albert Gruen, Art Director.

Editorial and Executive Offices
One Park Avenue
New York 16, N. Y. OR. 9-7200



MEMBER
INSTITUTE OF



BRANCH OFFICES: Midwestern Office, 64 E. Lake St., Chicago 1, Ill., John A. Ronan, Jr., manager; Western Office, Room 412, 215 W. 7th St., Los Angeles 14, Calif., John E. Payne, manager.

INDUSTRY NEWS

For the Record.....	W. A. Stocklin	8
Spot News.....	Washington Correspondent	31
Closed-Circuit TV.....	Tom Shea	35
An Eye for an Eye.....		37
3-D Color TV for the Future?.....	Milton S. Snitzer	39
Calendar of Events.....		90
Airborne Closed-Circuit Television.....		95
Receiving "Explorer's" Radio Signals.....	D. Ripani, W9JAQ	98
TV Circuits Puzzle.....	John A. Comstock	125

HIGH FIDELITY AND AUDIO

Microphones for Tape Recorders.....	Norman H. Crowhurst	43
Testing FM Tuners.....	Walter H. Buchsbaum	50
A Low-Cost Hi-Fi Amplifier.....	Leonard Kaplan	57
Hi-Fi—Audio Product Review.....		86
Certified Record Revue.....	Bert Whyte	100
Sound on Tape.....	Bert Whyte	126

SERVICING

Television-Radio

Basic Binary Counting Circuits.....	Ed Bukstein	48
Service Business Budgets.....	William Leonard	56
A Day in the Shop.....	Bob Eldridge	60
How the G-Y Signal is Used.....	Robert G. Middleton	62
Mac's Service Shop.....	John T. Frye	64
New TV Front End Designs.....	Walter H. Buchsbaum	65
Breakdowns in AM I.F. Transformers.....	John M. Doyle	92
Service Notes.....		120
Service Industry News.....		138
Antenna News.....		142

Test Equipment

The Cable Tracer-Checker.....	Forrest H. Frantz, Sr.	42
-------------------------------	------------------------	----

AMATEUR

The Zero Clipper.....	Hector E. French, W1JKZ	40
Transistorized Code Oscillator.....	John W. McDonald	47

ELECTRONIC CONSTRUCTION

A Transistorized Electronic "Accordion".....	Louis E. Garner, Jr.	53
Transistorized FM Receiver.....	Jack Najork	115

DEPARTMENTS

Letters from Our Readers.....	14	Technical Books.....	150
Within the Industry.....	24	What's New in Radio.....	152
Sales Aids.....	147	Manufacturers' Literature.....	158

Copyright © 1958 by Ziff-Davis Publishing Company. All rights reserved.
SUBSCRIPTION SERVICE. All communications concerning subscriptions should be addressed to Circulation Dept., 64 E. Lake St., Chicago 1, Ill. Subscribers should allow at least four weeks for change of address. Include your old address as well as new—enclosing, if possible, an address label from a recent issue of this magazine.

CONTRIBUTIONS: Contributors are advised to retain a copy of their manuscripts and illustrations. Contributions should be mailed to the New York Editorial Office and must be accompanied by return postage. Contributions will be handled with reasonable care, but this magazine assumes no responsibility for their safety. Any copy accepted is subject to whatever adaptations and revisions are necessary to meet the requirements of this publication. Payment covers all author's, contributor's, and contestant's rights, title, and interest in and to the material accepted and will be made at our current rates upon acceptance. All photos and drawings will be considered as part of the material purchased.

GET FREE FACTS

Let DeVry Tech
Prepare You in Spare Time To Be an
Electronics Technician

No Advanced Education Needed

Prepare now to get into one of the fastest-growing, big opportunity fields of the century—one that may give you that better job you've always wanted, the chance you've always needed.

You may be the boss in your own service shop. The trained man in Electronics is ready to step into one of the most profitable and exciting fields of our times.

More remarkable is the fact that you can get ready in your spare time at home. Or, if you prefer, you can attend day or evening classes in our well-equipped Chicago or Toronto laboratories.

Fill in coupon now! Don't forget—you need no previous technical experience. We will gladly give FREE facts to the man who wants to get ahead. Mail that coupon now! This could be the turning point in your life. Don't let it slip by!

Get FREE Booklet!

Get your free copy of an interesting booklet, "Electronics and YOU." See for yourself how you may take advantage of the opportunities in this fast-growing field.



MAIL TODAY FOR FREE FACTS

DeVry Technical Institute
4141 Belmont Ave., Chicago 41, Ill., Dept. RN-5-0
Please give me your FREE booklet, "Electronics and YOU," and tell me how I may prepare to enter one or more branches of Electronics as listed above.

Name _____ Age _____
PLEASE PRINT
Street _____ Apt. _____
City _____ Zone _____ State _____
 Check here if subject to Military Training.
DeVry Tech's Canadian Training Center is located at
2042 626 Roselawn Avenue, Toronto 12, Ontario

PROFITABLE JOB OPPORTUNITIES IN ELECTRONICS:

- Communications • Radar
- Television • Computers
- Guided Missile Control
- Industrial Electronics
- Automation Electronics
- Your Own Service Shop

ARE YOU OF DRAFT AGE?

If you are subject to military service, be sure to check the coupon and get valuable information.

CAN YOU DO IT?

Laborers, clerks, farmers, salesmen, men of nearly every calling have taken the DeVry Tech program and today have better jobs or Electronic service shops of their own—REAL PROOF of the effective training offered by DeVry Tech.

Employment Service

DeVry Tech's Placement Department is in contact with some of the best-known employers in the Electronics field. The service is free to all graduates—and DeVry Tech's record in helping to place men has been outstanding.

27 YEARS' EXPERIENCE!

For over 27 years we have trained many men for better careers. This can mean a great advantage for men like you—practical training KNOW-HOW designed to get RESULTS!

Accredited Member of National Home Study Council

"One of North America's Foremost Electronics Training Centers"



DEVRY TECHNICAL INSTITUTE

CHICAGO 41, ILLINOIS

Formerly DeFOREST'S TRAINING, INC.



UNIVERSITY INTRODUCES A VERSATILE NEW LOWBOY...

The Debonaire

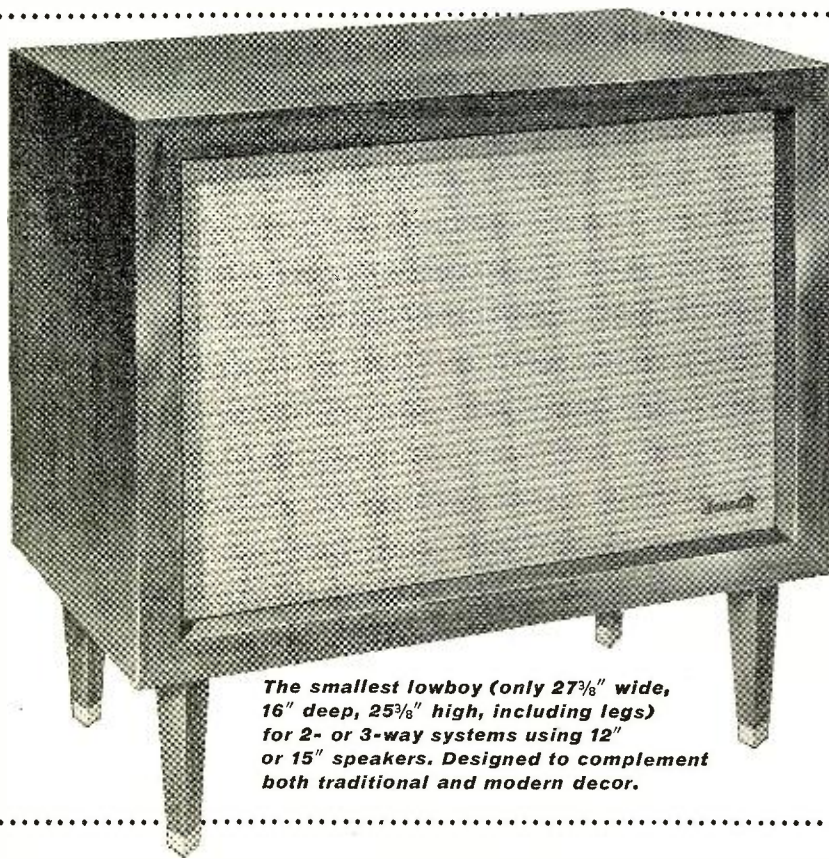

The smallest lowboy (only 27 $\frac{3}{8}$ " wide, 16" deep, 25 $\frac{3}{8}$ " high, including legs) for 2- or 3-way systems using 12" or 15" speakers. Designed to complement both traditional and modern decor.

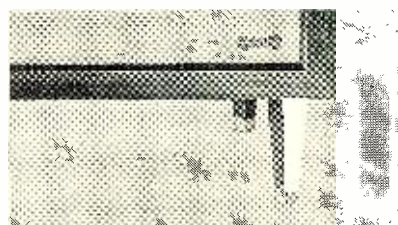

MODERN decor is accommodated by adjustment of the legs to this triangular position.

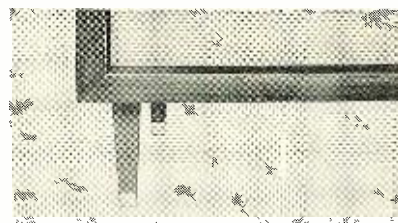

TRADITIONAL decor is accommodated when the legs are set "flat" in this position.

BRILLIANT NEW SYSTEMS AND ENCLOSURE

EN-1215 DEBONAIRE ENCLOSURE Designed for full-range reproduction, the EN-1215 DEBONAIRE enclosure employs the phase inversion principle to augment low frequency response. For versatility, it integrates direct radiation principles to permit using a wide variety of extended range speakers and 2- and 3-way Diffaxials. The versatile baffle board arrangements accommodate the many multi-speaker systems that may be developed with P•S•E—University's Progressive Speaker Expansion plan. P•S•E enables you to start modestly with an extended range speaker for immediate listening satisfaction and build up at your own pace to any one of a number of magnificent sounding speaker systems.

MODEL S-3 DEBONAIRE-12 SYSTEM This system, employing the same 3-way system components so successfully used in the University SENIOR, now makes this highly popular combination available to music lovers in both corner (SENIOR) and lowboy (DEBONAIRE) form. The basic C-12W 12" woofer (less frequency limiter) is ideally suited to the EN-1215 enclosure, reproducing deep bass tones cleanly and efficiently. Mid-range is covered by the new, improved H-600 "reciprocating-flare" horn with T-30 driver; treble range by the UXT-5 Super Tweeter clear out to 17,500 cps. The N-3 Acoustic Baton 3-way network crosses over at 700 cps for mid-range, 5000 cps for treble. PRESENCE and BRILLIANCE balance controls provide optimum adjustment to room acoustics and personal taste.

MODEL S-4 DEBONAIRE-15 SYSTEM An excellent three-element system with a unique approach to mid-range reproduction is achieved in this version of the DEBONAIRE. A 2-way 15" Diffaxial, the Diffusicone-15, is employed together with the new H-600 horn and new Hypersonic T-50 driver. The H-600, with hemispherical diffraction added, complements perfectly the T-50 driver to cover the mid and high ranges from 700 cps crossover to inaudibility. The Diffusicone-15 provides superior bass response to about 1000 cps where its multi-sectional Diffusicone element takes over for mid and high frequency response. With thus both the Diffusicone element and the horn/driver combination providing wide-angle response of the mid-range, this three-element system results in an expansion of spatial separation and an exciting blend of reed and woodwind mellowness (from the Diffusicone element) with the brightness of the brass (from the horn/driver). A balance control adjusts the system to room acoustics and personal taste.

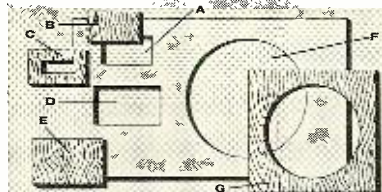

EN-1215 BAFFLE BOARD AND ADAPTERS

- A—Hole for tweeter Model HF-206 or 4401.
- B—Adapter blank to close hole A when tweeter not used.
- C—Adapter for Model UXT-5 tweeter.
- D—Hole for mid-range (Model H-600 horn).
- E—Adapter blank to close hole D when mid-range unit not used.
- F—Hole for Diffaxial Models 315-C, 6303, Diffusicone-15; woofer Models C-15W, C-63W.
- G—12" adapter (supplied) for Diffaxial Models 312, UXC-123; Coaxial Models 6201, Diffusicone-12, UXC-122 or Model 6200; C-12W woofer.

USER NET PRICES:

Finish	EN-1215	S-3	S-4
Mahogany	\$63.00	\$196.00	\$197.50
Blond	69.00	199.00	200.50
Walnut	69.00	199.00	200.50



University® sounds better



See your high fidelity dealer . . . or for FREE LITERATURE on University speakers, complete systems, enclosures and kits, write Desk S-3, University Loudspeakers, Inc., 80 So. Kensico Ave., White Plains, N. Y.

NRI'S PROFESSIONAL TELEVISION TRAINING

A Fast Way To Reach The Top In TV Servicing

Oldest and Largest Home Study Radio-TV School Trains You to Fix Any Set Easily, Quickly, Correctly

Professional Television Servicing is a field for the *trained* man, for the expert. The man who knows a "little" will soon be left behind. Time wasted in locating defects by "trial and error" methods can cost *you* money; easily made mistakes can mean callbacks, unhappy customers, even parts that cost money to replace.

Take time to get the training you need to get ahead, enjoy the high pay jobs. That is what NRI's Professional Television Training can do for you. *It is not for the beginner.* NRI's Professional Television Training is planned for the man with some knowledge of Television or Radio but who realizes his need to know *more*; so he can make Television repairs more quickly, confidently and accurately.

All-Practice Method

NRI's Professional Television Training is practical, complete. You do more than read about circuits or just build them. NRI is all-practice, guided training. NRI has spent years in developing training equipment you use to conduct Television Servicing experiments, make tests and thoroughly understand the causes and effects of Television problems. You get practical experience, first hand knowledge of Television Receiver defects, learn how to diagnose them and how to service them.

All equipment is yours, to keep. The professional quality 5" Oscilloscope you build will be a valuable part of your Servicing Equipment. You get other kits, developed to speed your knowledge and confidence, including a 17" picture tube

Scientifically Developed Equipment for Training Makes Learning Fast, Efficient, Practical

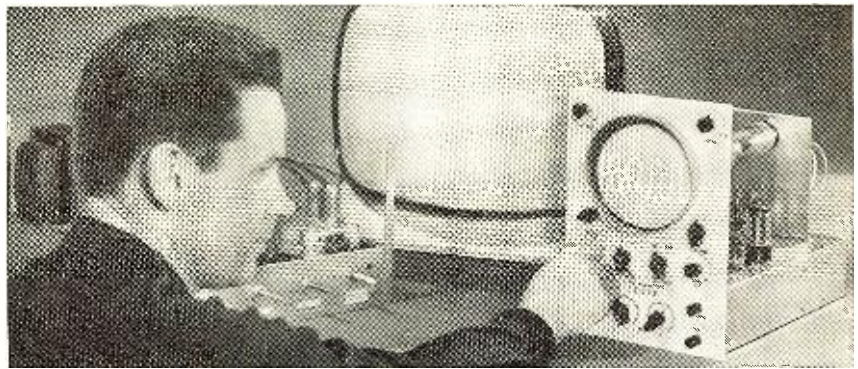

and all components for a TV receiver that you build to learn circuitry and make tests; setting up defects just as they might occur in actual servicing.

Color TV Manuals Early

The day you enroll, NRI sends you special Color TV manuals to give you knowledge of this growing phase of TV. Full color pictures, diagrams help speed your training.

There is no better way to get Professional Television Training than through NRI. NRI is the oldest, largest home study Television-Radio school. For over 40 years, NRI's business has been TRAINING men for success in Television-Radio. NRI graduates hold jobs in every part of the industry. NRI methods are tested, proved. You train at home in spare time, get personal attention from instructors who are specialists in Television techniques.

Not For Beginners

NRI's Professional Television course condenses knowledge and experience that would take years of hit-and-miss learning. You learn how *experts* diagnose and repair TV defects. You are shown *professional* techniques to help you service

ANY MAKE, ANY MODEL Television receiver properly and without wasted time and effort. You know the "what" and the "why" of TV Servicing, so you can compete with other professionals.

Send For FREE Catalog

Mail the coupon now for free catalog of what you learn, equipment supplied. Cost of entire course, all training equipment, Color TV manuals, etc. is low. Monthly terms if desired. NATIONAL RADIO INSTITUTE, Dept. 8 EET, Washington 16, D. C.

National Radio Institute

DEPT. 8 EET, WASHINGTON 16, D. C.

Please send my FREE copy of "How to Reach the Top in TV Servicing." I understand no salesman will call.

Name.....Age.....

Address.....

City.....Zone.....State.....

Accredited Member National Home Study Council



**"The man who
learns more...
earns more"**

The professional TV Serviceman earns good money, enjoys respect and the opportunity of a secure, growing profession. But you can't afford to "guess." You must have training to succeed. NRI can provide it for you.

J. E. Smith
FOUNDER

Leading Set Makers
Specify Tung-Sol

High

IN PERFORMANCE

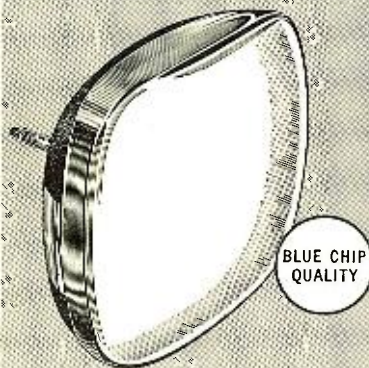

Leading Independent
Service Dealers
Choose Tung-Sol

LOW

IN CALLBACKS



TUNG-SOL

Magic Mirror Aluminized
PICTURE TUBES
RECEIVING TUBES

ELECTRON TUBE DIVISION
TUNG-SOL ELECTRIC INC., NEWARK 4, N. J.

For the RECORD.

AN INDUSTRY RESPONSIBILITY

EVERY major city has its problems in crime, fraud, rackets, etc. For the most part, people do not pay too much attention to such conditions but when headlines scream out the fact "Tube Racket in Electronics Industry Exposed," we, as well as everyone in the industry, are deeply concerned.

Judge Samuel Joseph of Bronx County here in New York recently passed sentence on ten individuals and six corporations in an illegal rebranding operation that cost the industry and the public about five million dollars in the period from 1953 to 1957. This isn't the first time this has happened. In 1956 *General Electric Company*, through diligent detective work, brought charges against Joseph Lynch for illegal tube rebranding which resulted in a conviction. They were not alone in their efforts. Other tube manufacturers have been closely scrutinizing their operations and, wherever possible, eliminating similar situations.

RCA was criticized by Judge Joseph, not for any illegal operation, but for not taking remedial action when it became aware of the situation with regards to its products in 1953.

All radio and television tubes, when marketed, have a warranty period during which they can be returned for full credit if they are faulty in any way. Manufacturers simply code their tubes to indicate the date the warranty expires. It has not been a difficult task for illegal operators to pick up vast numbers of faulty tubes whose warranty has expired and simply change the coding, by a rebranding operation, to bring it within the returnable time limit. These tubes are then returned to the manufacturer for full credit. The manufacturers are, in the last analysis, the ones who have been paying through the nose, losing thousands of dollars every year.

There are many aspects to this kind of an operation and, for those who are interested in complete details, we would like to refer them to the article entitled, "The Tube Racket," published in the July, 1956 issue of *RADIO & TV NEWS*. The details, as exposed in the article, are identical to those in the case just concluded here in New York.

How is the general public affected by such illegal acts? Actually, they are not involved in any way with the rebranding operation, as such. There are, however, a few service shops and individual technicians who make a practice of replacing worn out radio and television tubes with either seconds or used tubes. This practice of installing used tubes is not a crime

but it is definitely illegal for anyone to charge the customer the full price of a brand new one in such cases. This practice, unfortunately, reflects on the integrity of every service technician and shop in the industry. Actually, there are only a few who are making it extremely difficult for those who operate their businesses ethically. Our industry is not the only one plagued by such problems. All service-type organizations, whether they be in the automotive or appliance fields, have a few operators that rock the boat of customer confidence, making it extremely difficult for the rest of the industry.

There has been some criticism of organizations which sell used or surplus components. There is certainly nothing illegal in such operations nor do they differ greatly from the used car operation in the automotive industry. Any company or manufacturer has the right to sell used products provided they are clearly designated as such.

A large percentage of the surplus tubes which are sold to dealers for resale to the public are unused tubes obtained from electronic equipment manufacturers who may have gone out of business, changed the design of their equipment, or had an over-run. Although these tubes are technically "unused," they should not be offered to the consumer as brand new items. In all fairness, they should be sold as surplus and all promotional material should so state.

This entire situation, which hardly redounds to the credit of the industry, should not be taken lightly. It is serious and no doubt we have not heard the last of it. Everyone connected with the industry should take every possible step within his means to stop such illegal practices. The consumer, for one, should always make sure when tubes are replaced in his radio or television set that they are actually new ones or, if not, that he is not charged the full price for a surplus item. The service technician or shop owner should report any such illegal practices if he encounters them in the course of his work. If tube manufacturers make every possible effort to prevent recurrence of such tube rebranding, the sheer weight of such suasion would make it difficult for any individual or organization to continue such illegal operations. If the EIA, as spokesmen for our industry, continues its efforts to clean house as it has in the past, it would add impressive weight to this industry-wide campaign. . . . W.S.

FREE!

ALLIED'S 1958 CATALOG

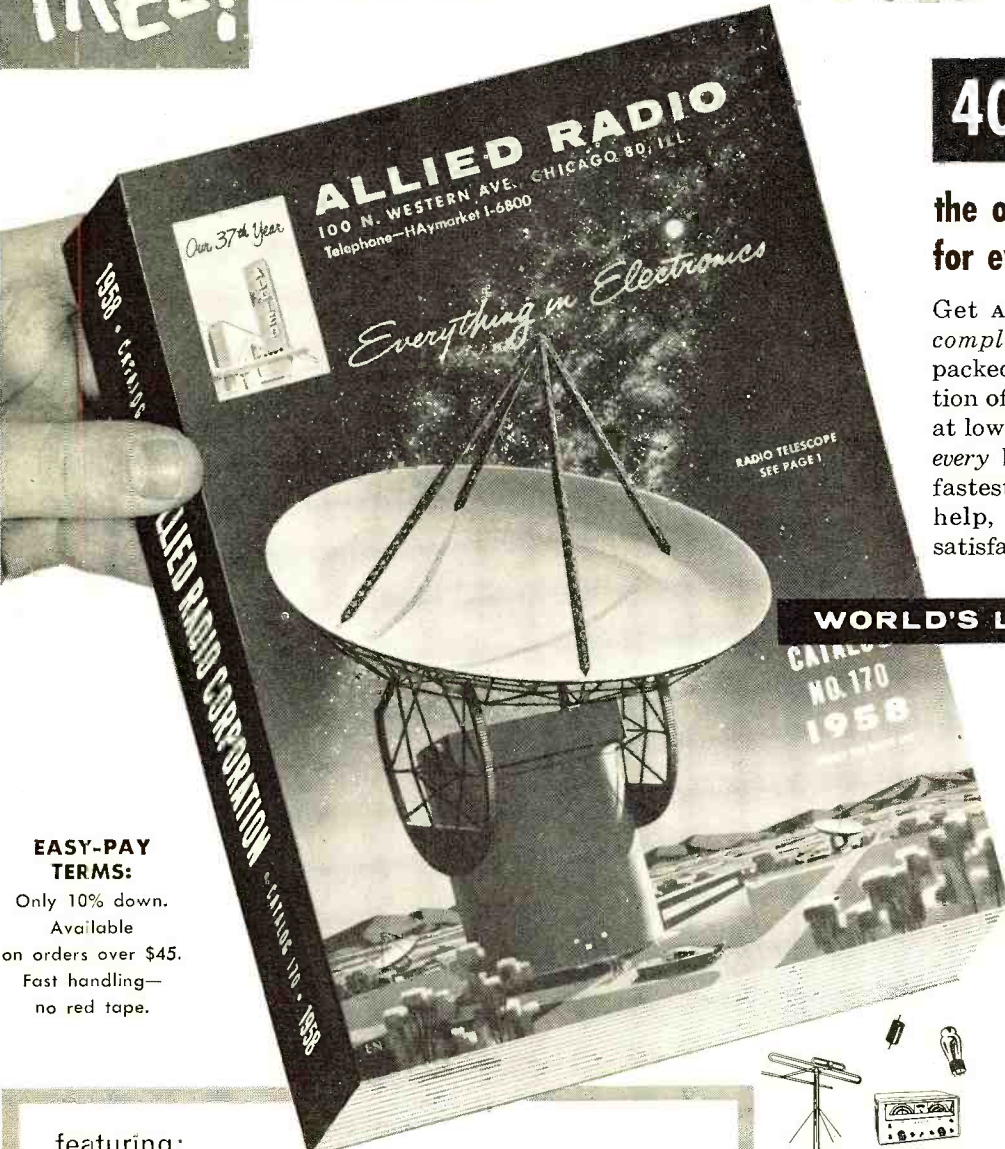

404 value-packed
PAGES

the only **COMPLETE** catalog
for everything in electronics

Get ALLIED'S 1958 Catalog—it's complete, up-to-date—404 pages packed with the world's largest selection of quality electronic equipment at lowest, money-saving prices. Get every buying advantage at ALLIED: fastest shipment, expert personal help, lowest prices, guaranteed satisfaction...

WORLD'S LARGEST STOCKS

- Latest Hi-Fi Systems and Components
- Money-Saving, Build-Your-Own KNIGHT-KITS
- Recorders and Supplies
- Public Address Systems and Accessories
- TV Tubes, Antennas and Accessories
- Amateur Receivers, Transmitters, Station Gear
- Test & Lab Instruments
- Specialized Industrial Electronic Equipment
- Huge Listings of Parts, Tubes, Transistors, Tools, Books

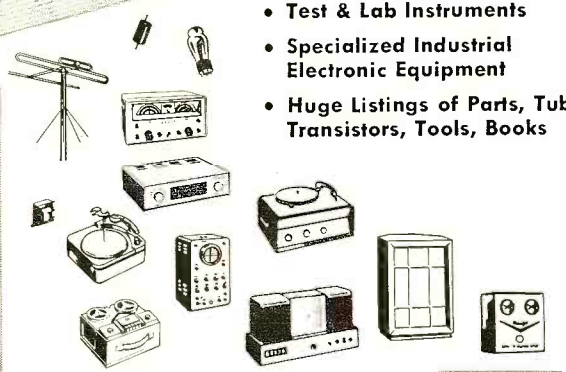

EASY-PAY TERMS:

Only 10% down.
Available on orders over \$45.
Fast handling—no red tape.

featuring:

ALLIED'S money-saving knight-kits:
Finest electronic equipment in money-saving kit form. Over 50 quality kits available—Hi-Fi amplifier, tuner and speaker kits, Hobby kits, Test Instruments, Ham kits (see our KNIGHT-KIT values elsewhere in this publication). ALLIED KNIGHT-KITS are easiest to build and they SAVE YOU MORE.

EVERYTHING IN HI-FI

World's largest selection of quality Hi-Fi components and complete music systems—available for immediate shipment from stock. Save on exclusive ALLIED-Recommended complete systems. Own the best in Hi-Fi for less!



Our 37th Year

ALLIED RADIO

World's Largest Electronic Supply House

send for the leading
electronic supply guide **FREE!**

ALLIED RADIO CORP., Dept. 1-E8
100 N. Western Ave., Chicago 80, Ill.

Send FREE 404-Page 1958 ALLIED Catalog

Name _____

Address _____

City _____ Zone _____ State _____

May, 1958

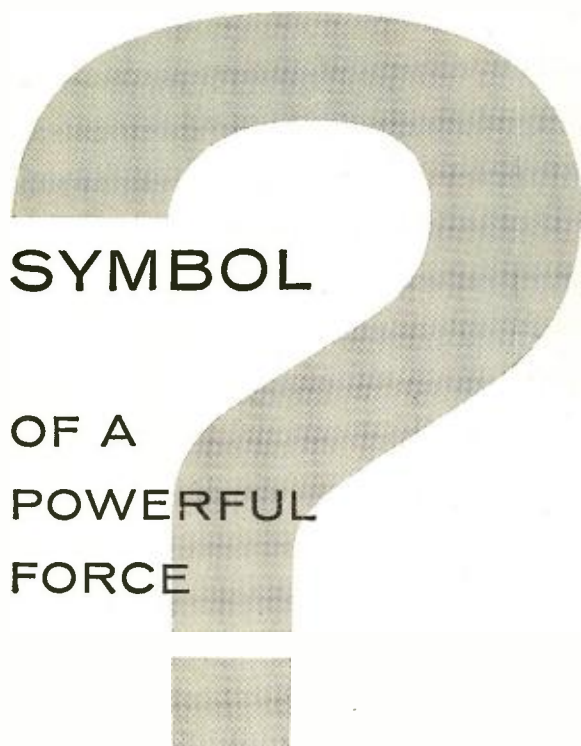

**SYMBOL
OF A
POWERFUL
FORCE**

The question mark symbolizes man's inquiring spirit. And nowhere is this spirit cultivated with more enthusiasm than at Bell Telephone Laboratories where, through vigorous research and development, it constantly works to improve electrical communications and also to help national defense in essential military programs.

More than 3000 professional scientists and engineers at Bell Telephone Laboratories are exploring, inventing and developing in many fields: chemistry, mathematics and physics, metallurgy, mechanical engineering, electronics and others. You see the successful results achieved by this organization of inquisitive and highly trained minds in the nationwide telephone system that serves you.

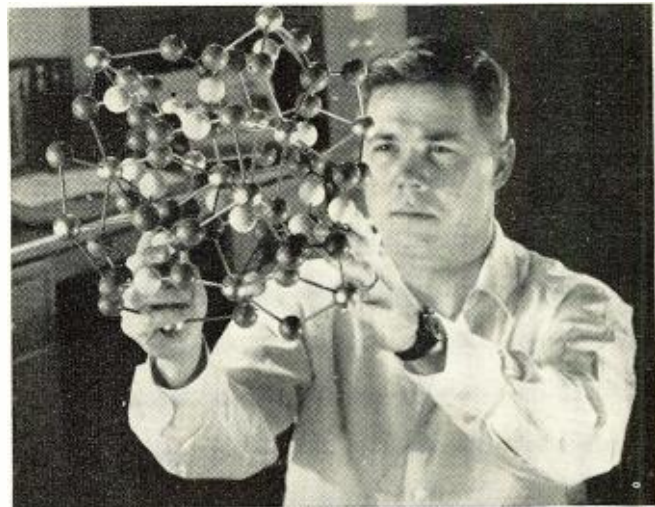

Dr. Walter Brown, physics graduate of Duke and Harvard Universities, bombards crystalline solids with one-million-volt electrons to study the nature of simple defects in crystals. Objective: new knowledge which may help improve transistors and other solid state devices for new and better telephone and military systems.



Peter Sandsmark, from Polytechnic Institute of Brooklyn, and his fellow electrical engineers develop a new microwave radio relay system able to transmit three times as much information as any existing system. Objective: more and better coast-to-coast transmission for telephone conversations and network television.



Bill Whidden, from Polytechnic Institute of Brooklyn, and George Porter, from Georgetown College, study new experimental telephone instruments designed to explore customer interest and demand. Objective: to make your future telephone ever more convenient and useful.



BELL TELEPHONE LABORATORIES

WORLD CENTER OF COMMUNICATIONS RESEARCH AND DEVELOPMENT

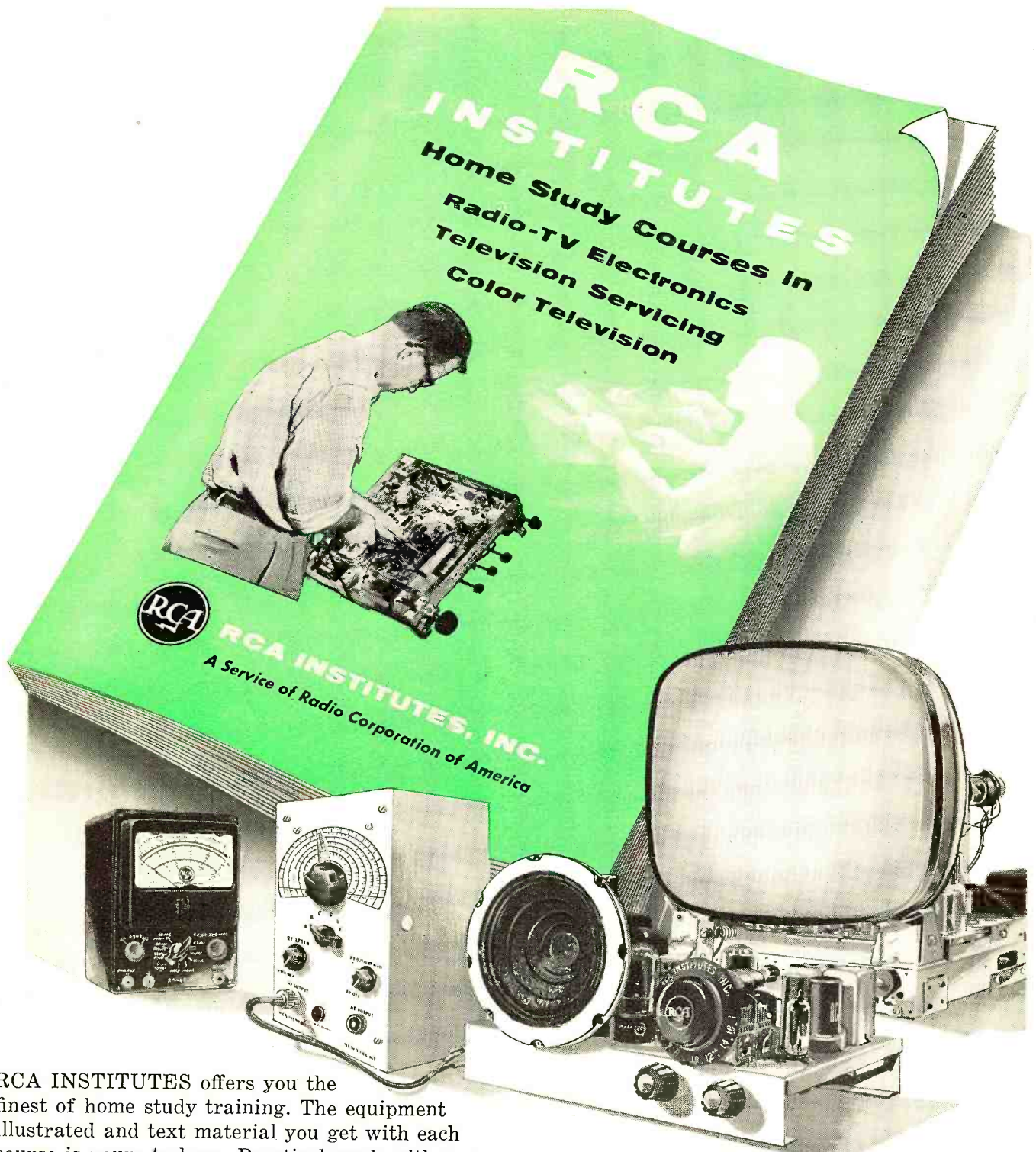

RCA INSTITUTES offers you the finest of home study training. The equipment illustrated and text material you get with each course is yours to keep. Practical work with very first lesson. Courses for the beginner and the advanced student. Pay-as-you-learn. You need pay for only one study group at a time.

**Send for this
FREE Book Now** 

RESIDENT SCHOOL courses in New York City offer comprehensive training in Television and Electronics. Day and evening classes start four times each year.

Detailed information on request

RCA INSTITUTES, Inc. Home Study Dept. RN-58

A Service of Radio Corporation of America
350 West Fourth Street, New York 14, N. Y.

Without obligation, send me FREE 52 page CATALOG on Home Study Courses in Radio, Television and Color TV. No salesman will call.

Name please print

Address

City Zone State

Korean Vets! Enter discharge date.....

In Canada — RCA Victor Co., Ltd.
5001 Cote de Liesse Rd., Montreal 9, Que.

To save time, paste coupon on postcard.

Use Delco Radio Service Parts!

2N278—Highest power transistor used in auto radios.

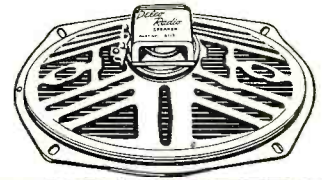

SPEAKERS



IRON CORES



RESISTORS



CAPACITORS

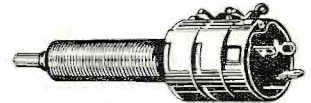

CONTROLS



TUBES



COILS



VIBRATORS

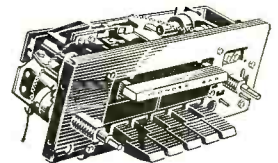

TUNER PARTS

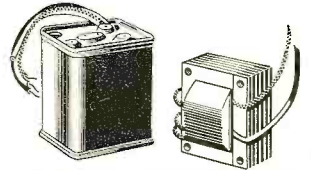

TRANSFORMERS

Your Delco Radio Electronic Parts Distributor carries the complete line, giving you fast, dependable service on the items you'll need for Delco Radio—and other radio—service work. Delco Radio also provides:

- Wide selection of special application parts
- Complete technical training program
- Effective warranty program
- Dealer identification signs

Get the facts today on this truly profitable dealer setup, and grow with General Motors!

Available everywhere through Electronic Distributors associated with . . .



DELCO RADIO

DIVISION OF GENERAL MOTORS, KOKOMO, INDIANA

RADIO & TV NEWS

HOW TO PASS Your FCC Commercial LICENSE EXAMS*

Get your FCC license in a hurry!

Get your FCC Commercial License — or your money back

See Free Catalog for complete details

Cleveland Institute training results in success
with commercial FCC examinations
... easily ... and quickly

"License and Good Job . . . Thanks"

"After finishing your Master Course, I passed the FCC exam for the 1st class license. I had my ticket for only one week and I got a job at WOC-TV, AM-FM. Incidentally, WOC is the oldest radio station west of the Mississippi. I sincerely feel that if it weren't for taking your Master Course, I would not have received my 1st class ticket. So I want to take this occasion to again thank you for such a fine, complete and composite study for electronics work."

Francis J. McManus
Davenport, Iowa

Cleveland Institute training results in job offers like these:

Broadcast Station in Illinois:

"We are in need of an engineer with a first class phone license, preferably a student of Cleveland Institute of Radio Electronics; 40 hour week plus 8 hours overtime."

West Coast Manufacturer:

"We are currently in need of men with electronics training or experience in radar maintenance. We would appreciate your referral of interested persons to us."

CLEVELAND INSTITUTE OF RADIO ELECTRONICS
Desk RN-17 4900 Euclid Bldg. Cleveland 3, Ohio

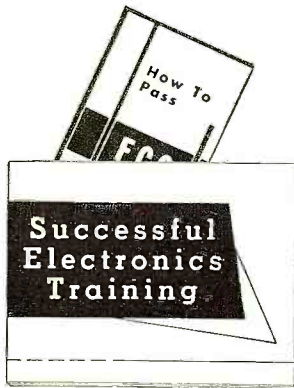

We can train you to pass your License Exams if you've had any practical experience—amateur, military, radio servicing, or other. Our proven plan can help put you on the road to success.

* Your FCC ticket will be recognized by employers as proof of your technical ability.

**Mail Coupon Now
and get
both
FREE**

Accredited by the National Home Study Council

Cleveland Institute of Radio Electronics

Desk RN-17, 4900 Euclid Bldg., Cleveland 3, Ohio

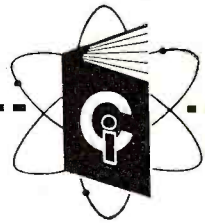

Please send Free Booklets prepared to help me get ahead in Electronics. I have had training or experience in Electronics as indicated below:

- | | |
|---|---|
| <input type="checkbox"/> Military | <input type="checkbox"/> Broadcasting |
| <input type="checkbox"/> Radio-TV Servicing | <input type="checkbox"/> Home Experimenting |
| <input type="checkbox"/> Manufacturing | <input type="checkbox"/> Telephone Company |
| <input type="checkbox"/> Amateur Radio | <input type="checkbox"/> Other _____ |

In what kind of work are you now engaged?

In what branch of Electronics are you interested?

Name _____ Age _____

Address _____

City _____ Zone _____ State _____

RN-17

HARVEY has it...
FOR IMMEDIATE DELIVERY

THE LATEST FROM *Collins*

Collins **KWM-1**

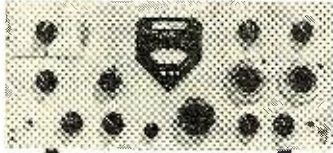

first SSB transceiver for **complete Mobile or Fixed use**

The revolutionary KWM-1, the first mobile transceiver to offer SSB. And this 14-30 mc 175 watt package is equally adaptable to fixed use with simple removal from a convenient mounting tray under the dashboard.

Utilization of common components in both transmitting and receiving functions results in a saving of both space and cost and, in the case of frequency-determining components, assures exact coincidence of transmitted and received signals. Frequency stability and readability is comparable to that of the KWS-1/75A-4. The panel meter serves as an S-meter during receive and multimeter during transmit. Break-in CW using VOX circuits is built-in, as is a side tone for monitoring CW. Ten 100 Kc bands are available anywhere in the 14-30 mc range.

NET PRICES

KWM-1 Transceiver	\$820.00
514E-1 12 vdc Power Supply	262.00
514F-1 115 vdc Power Supply	136.00
312B-2 Speaker Console with phone patch and directional wattmeter	185.00
312B-1 Speaker in cabinet	25.00
351D-1 Mobile Mounting Tray	86.00

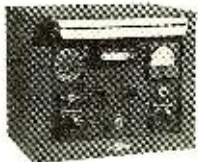

Collins
SC-101
STATION CONTROL

For Smooth Coordination of Complete SSB Station

The SC-101 provides the necessary equipment to connect the Collins 75A4 and KWS1 with beam direction indicator and control, phone patch circuit, standing wave ratio meter and remote selection of any one of six antennas. *There are three units included in the system:*

SPEAKER/CONTROL UNIT . . . 312A-2	
ANTENNA SELECTOR . . . 68Y-1	
WIRING DUCT & HARNESS . . . 534A-1	
	\$695.00



Cesco **STANDING WAVE REFLECTOMETER**

FOR 52 -OHM COAX

Here's a high quality device for continuous measurement of standing waves on transmission lines. Suitable for frequency range from 3 to 200 mc. See the article in QST June '57

Complete, with instructions
\$29⁹⁵

FEATURES: Uses sensitive 0-100 microamp meter • For continuous line insertion • Power to 1000 watts and over • Prevents false loading from antenna tuner, match box, PI network • SWR observed immediately at all times without adjustment •

We're Generous on Trade-Ins If You Want to Talk SWAPS and DEALS write, or call **W2DIO**

Prices Net, F.O.B. N.Y.C.
Subject to change without notice

Established 1927
HARVEY RADIO CO., INC.
103 West 43rd St., New York, N. Y.
JUdson 2-1500



LIGHT OF THE FUTURE

To the Editors:

It is said that Science Fiction is only a step or two ahead of science. Panels similar to the electroluminescent panels described in the January issue of RADIO & TV NEWS have been prominently mentioned in fiction for some time.

Allow me to congratulate you on being among the first to carry an article that covers the real thing so thoroughly.

RICHARD G. BROCKMAN
Oxnard Air Force Base, Calif.

Both we and the author of our lead article for January ("Electroluminescence—Light of the Future") have received many favorable comments from our readers. We're glad you liked the article.—Editor.

* * *

RUSSIAN BROADCAST SET

To the Editors:

I have come into possession of a Russian broadcast receiver which is very unusual in that it is operated by the heat of a kerosene lamp, through the use of a thermocouple. The set is a full superhet using seven 1.2-volt tubes. A vibrator supply is used to deliver 90 volts to the plates of the tubes. The kerosene lamp and thermocouple are quite large. As a matter of fact, the lamp lights and heats the room as well as supplies power for the radio.

The radio has been built for the underprivileged countries of the Middle East. All instructions are printed in Russian; however, the schematic is straightforward and is easily understood.

(Name withheld)
Tripoli, Libya

We are certainly very interested in learning a little more about the receiver. The idea of using a thermocouple that is heated by means of a kerosene lamp strikes us as really trying to tie together the new and the old.—Editor.

* * *

MIDGET RADIO ALIGNMENT

To the Editors:

I have just finished reading "Alignment of Midget Radios" by J. Richard Johnson, which appeared in your January issue. The article is a very informative one containing much useful material. However, I would like to add a few suggestions of my own as a result of almost 15 years experience in servicing:

1. Oscillator alignment should be performed at 1620 kc. and with the tuning capacitor completely open.

2. R.f. and mixer alignment should then be done at 1400 kc. If the trimmer does not align at nearly full capacity, remove one-half to one turn at a time from the loop until it does. If you find there is not enough inductance in the loop to align properly, you might try replacing it with a ferrite-core loop. Follow the instructions that come with this loop carefully. Your customers will thank you for the improvement.

RAY LOEWEN
Ray's TV & Radio Shop
Inola, Oklahoma

A good suggestion that we are glad to pass along.—Editor.

* * *

BUY HI-FI NOW OR LATER

To the Editors:

We recently have been considering the possibility of purchasing a packaged hi-fi system. We are wondering whether you have evaluated this particular unit and would you recommend it?

Another problem we have is this. The hi-fi field seems to be moving so fast and there are so many new developments that I don't know whether I should buy anything at all now. Perhaps I should wait for something altogether new before deciding to buy at this particular time. What do you think?

JOHN NICHOLS
Steubenville, Ohio

Just about the very best answers that we can give to the questions outlined above are contained in the article "Which Way to High Fidelity?" in our February issue. This article should be must reading for anyone contemplating the purchase of a hi-fi system.—Editor.

* * *

G-E CARTRIDGE LOAD

To the Editors:

In your December 1957 issue on page 67 you show frequency response curves for the new General Electric VR-II phono cartridge. On this same page the article points out "Where interstage record compensation is used, the minimum load across the cartridge should be 100,000 ohms."

The writer has just built a preamplifier kit having separate turnover and roll-off controls. Would these controls be what the author has referred to as interstage record compensation? The load resistor on my G-E VR-II is the value supplied by the kit manufacturer—namely, 22,000 ohms. The author of the article in question mentions that if load resis-

THERE IS A DIFFERENCE IN P. A. SPEAKERS

you get a lot more to sell with

Electro-Voice®

CDP® SPEAKERS

Yes, Electro-Voice gives you more to sell and more help in selling P. A. speakers. Hard-hitting, sales-pulling ads pre-sell architects, buyers in schools, universities, colleges, industry and all your prime P. A. prospects. They are told the CDP story . . . and what a terrific story it is. To tell it is to sell them!

Model 848 for the bigger jobs.
25 watts. 16 ohms. Response, 175
—10,000 cps. crossover at 1000
cps. RETMA sensitivity rating, 52
db. Size, 10½" x 20½" x 20."
Wt., 12 lbs. List. \$75.00.

Model 847 CDP for smaller areas.
12 watts. 16 ohms. Response, 250
—10,000 cps. crossover at 1500
cps. RETMA sensitivity rating, 51
db. Size, 11¾" x 7¾" x 10½".
Wt., 6½ lbs. List. \$46.33.

HERE'S WHY CDP SPEAKERS ARE SO SUPERIOR, SO MUCH EASIER TO SELL THAN CONVENTIONAL P. A. HORNS . . .

High frequencies require one throat size and one horn taper rate; low frequencies require a different throat size and a different taper rate. The Electro-Voice CDP gives you a large horn (A), for lows and a second, smaller horn (B), coaxially mounted, for highs working from both sides of a single diaphragm (C). The Electro-Voice CDP gives you 2½ more octaves of sound reproduction . . . frequencies up to 10,000 cps. These 2½ octaves are indispensable for highest intelligibility. See the curve, compare response and efficiency. In addition, Electro-Voice CDP speaker disperses sound through a solid 120° angle for the widest coverage available in P. A. speakers.

You can hear the difference.

Conventional reentrant horns using single throat (D) and single horn (E) transmit highs along the same circuitous path (F) as required for lows. As a result, the highs become attenuated, sharply decreasing intelligibility. Electro-Voice gives you P. A. speakers with a large horn for lows and a second, smaller horn, coaxially mounted, for highs. **There is a difference and you can hear it.**

1 This is a CDP Speaker with its two coaxially mounted diffraction horns.

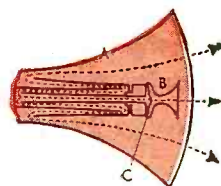

2 This is the frequency response curve of a CDP.

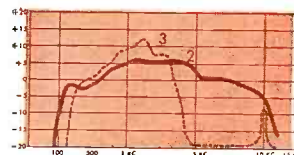

3 This is the frequency response curve of a conventional P. A. horn.

4 This is a conventional reentrant-type P. A. horn.

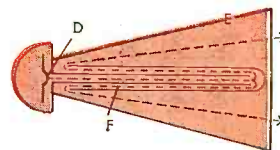

Electro-Voice

ELECTRO-VOICE, INC., BUCHANAN, MICHIGAN

EXPORT: 13 East 40th Street, New York 16,
U. S. A. CABLES: ARLAB.

CDP speakers are weather-proof, blast-proof and splash-proof, virtually indestructible. They're molded of fiber-glass for better acoustical properties and extra strength.

Sell CDP Speakers . . . the speakers that sell because they are clearly superior. See your Electro-Voice Distributor TODAY. Get the facts and start selling the most revolutionary speakers in P. A. history . . . the Electro-Voice CDP.

Send for bulletin 195-N85

JERROLD MF-2: THE 2-SET COUPLER WITH GUTS!

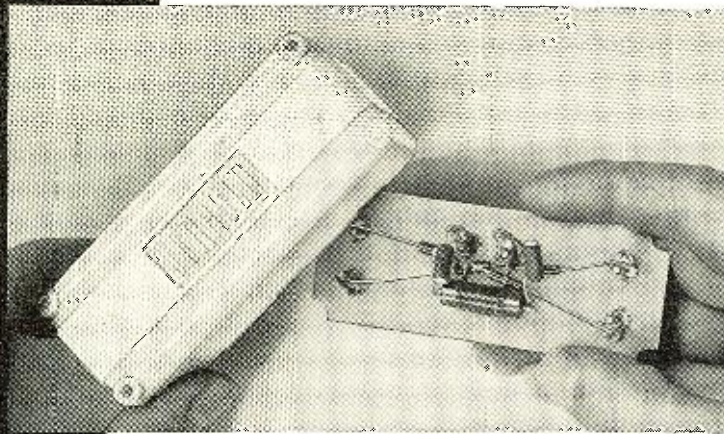

The MF-2 Doesn't Care Where It's Used!

Even though the impedance of most TV sets varies greatly from 300 ohms, the low-loss MF-2 doesn't care. Its special electronic circuit consisting of a resonated auto transformer with stabilizing resistors will produce positive results—prevent interference between sets—will not introduce ghosts!

USE FOR TV and/or FM

The MF-2 has quickly become the leading coupler in the industry. Attractively packaged . . . universal mounting for easy installation.

\$4.50 LIST

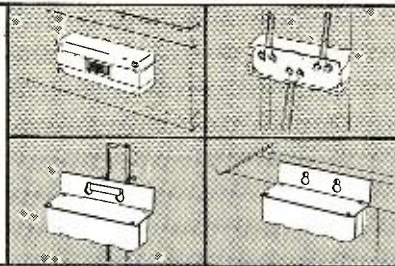

Order the MF-2 From Your Jerrold
Distributor Today, or Write:

JERROLD

ELECTRONICS CORPORATION
Dept. PD53, Philadelphia 3, Pa.

tors on the order of 25,000 or 50,000 ohms are used, these produce undesired treble roll-offs at 15 kc. The kit as is sounds terrific; however, where the possibility of improvement exists the writer would gladly roller skate all the way across the Sahara Desert and back again.

SAMUEL J. ROSS
Metairie, Louisiana

Most preamps use the type of record equalization referred to in the article mentioned above. In such cases the cartridge is simply loaded with a sufficiently large resistor to maintain flat high-frequency response, then the required correction is applied later in the preamp circuit. The use of 22,000 or 47,000 ohm resistors directly across the cartridge was quite satisfactory for most of the older cartridges. But in the case of the new G-E unit, as the article pointed out, these values will produce some treble roll-off. Therefore we recommend that the 22,000 ohm resistor supplied by the kit manufacturer be replaced with a 100,000 ohm unit.—Editor.

* * *

DRUG STORE TUBE TESTERS

To the Editors:

You might be interested in an incident that happened in my shop recently. A customer brought in 15 tubes to be tested. Eight of the 15 were burned out. On questioning, he broke down and admitted that he had tested them himself in a drug store. He thought it strange that some of them lit up like flash bulbs. The drug-gist knew from nothing. I sold him \$20 worth of new tubes.

ARTHUR SILVERBERG
Sil-Rad Laboratories
New York, N. Y.

Need we say more?—Editor.

* * *

BROADCAST BAND OSCILLATOR

To the Editors:

Recently I constructed a "Knight-Kit" Wireless Broadcaster sold by *Alied Radio*. The oscillator was of good design but it was extremely low in power and would only send voice modulated signals a short distance. I am writing to you hoping that you could help me find a suitable plan for construction of an oscillator with a much higher output power. Also I would like to know if a phonograph could be connected to such a unit in order to broadcast signals over a greater distance.

DONALD F. DEKOLD
Vero Beach, Florida

We have received a good many letters from our readers along these very lines. We would like to point out that the use of high power broadcast oscillators is prohibited by law unless such units are officially licensed by the FCC as a broadcast station. As a matter of fact, the only reason the wireless oscillator is allowed at all is that it has such a low power that it will not produce harmful interference.

NEW

DEALER

BUSINESS BUILDERS

SALES PROMOTION MATERIAL

TECHNICAL LITERATURE

CATALOG

SERVICE TOOLS

CBS-HYTRON SALES CORPORATION

A Subsidiary of Columbia Broadcasting System, Inc.



4th Edition

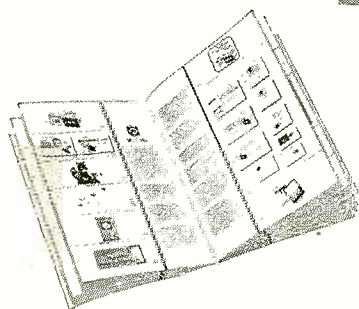

ILLUSTRATES AND DESCRIBES...

... service tools • tube caddy • drop cloth • shop coat, shirt, pants • engineer's and technician's handbooks • reference guides, charts, manuals • Tube Tips • Transistor Course • price lists • job tag • repair sticker • door-knob hanger • ad mats • radio and TV scripts • direct-mail postal cards • consumer booklet • stationery • book matches • dealer giveaways • decals • window valance • window streamers • satin banner • giant tube carton • clock • clock-sign • flange and metal hanging signs • illuminated indoor and outdoor signs.

This book can build business for you.

That's a promise! Get a free copy of this new Fourth Edition of the Business Builders Catalog and see for yourself. Check the more than 90 items ranging from new Printed-Circuit Soldering Aids to new Illuminated Outdoor Signs. You'll find that each is designed with you, the independent service-dealer, in mind. Put them to work. Prove to yourself that they can build more service and tube business, more profits for you. Ask your CBS Tube distributor (or us) for your copy of Business Builders Catalog, PA-37 ... today!

ELECTRON TUBES



CBS-HYTRON

Danvers, Massachusetts

A Division of

Columbia Broadcasting System, Inc.

For the best in entertainment tune to CBS

First

from PACO

Manufacturers of quality electronic equipment in kit form.

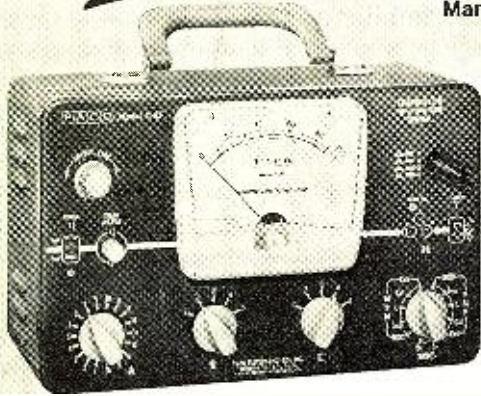

TRANSISTOR and Crystal Diode TESTER in kit form

Model T-65 only \$39.95

60% of all 1958 electronic equipment will include transistors and diodes.

PACO, the only test instrument kit line produced under the auspices of a major test equipment manufacturer, is the first to bring you a comprehensive transistor tester in kit form—available at your local distributor. This is the instrument you *must* have to maintain modern electronic equipment!

Produced in accordance with the recommendations of leading transistor manufacturers, PACO's T-65 provides comprehensive tests for I_{cbo} , gain, leakage, shorts, etc., on low, medium and high-power transistors of both the p-n-p and n-p-n types, as well as tetrode transistors.

25 YEARS OF PRECISION KNOW-HOW IS YOURS IN PACO KITS

MODEL V-70 VACUUM TUBE VOLTMETER KIT

- wide-range • peak-to-peak NET PRICE: \$31.50



MODEL B-10 BATTERY ELIMINATOR KIT

- less than 0.3% ripple • no external filters required NET PRICE: \$41.95



MODEL G-30 RF SIGNAL GENERATOR KIT

- 160 Kc to 240 Mc in 8 bands • 120 Mc fundamental NET PRICE: \$28.50

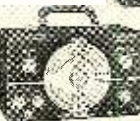

MODEL G-30-PC Same as Model G-30 but with pre-wired and precalibrated front end. NET PRICE: \$35.50



MODEL S-50 5" CATHODE RAY OSCILLOSCOPE KIT

- push-pull vertical and horizontal amplifiers. NET PRICE: \$49.50



MODEL C-20 RESISTANCE-CAPACITY-RATIO BRIDGE KIT

- 10 mmfd to 2000 mfd • ½ ohm to 200 megs NET PRICE: \$20.95



MODEL T-60 TUBE CHECKER KIT

- full free-point lever selector system NET PRICE: \$38.75



MODEL Z-80 RF-AF SIGNAL TRACER KIT

- High gain RF & AF amplifier • Visual-audible indicator NET PRICE: \$29.50

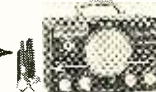

MODEL M-40 HIGH-SENSITIVITY V-O-M KIT

- 20,000 ohms/volt DC • 10,000 ohms/volt AC NET PRICE: \$31.50



► Available and on display at leading electronic parts distributors. Write for free descriptive bulletin.

PACO ELECTRONICS CO., INC.

70-31 84th Street, Glendale 27, Long Island, New York

A DIVISION OF **PRECISION** Apparatus Company, Inc.

Export: 458 B'way, N. Y. 13, U.S.A., Canada: Atlas Radio Corp., Ltd., 50 Wingold Ave., Toronto 19.

If the power were to be increased, then interference would be produced. Definite radiation limits on phono oscillators have been set forth by the FCC. If these limits are exceeded, operation becomes illegal.—Editor.

CALL FOR TAPES

To the Editors:

Every week we have a one hour program, which is tape-recorded, for all the patients here at the Baker San with tuberculosis. It's made up of doctor's talks, news, and music. And here's what we had in mind from your interested readers. A tape, up to about 15 minutes playing time, describing hobbies, sports, occupations, unusual interests would be of interest to the 250 patients here. Tape speed of 3¾ ips is preferred. If you want your tape returned, let us know. Otherwise we will forward the tape to other interested institutions.

ROBERT C. SHELSKA
Baker San,
Calgary, Alta., Canada

This seems like a worthy cause.—
Editor.

"MUSCLE MOUSE" PRECAUTIONS

To the Editors:

In developing the "Muscle Mouse" a.c.-d.c. 50-watt transmitter (February 1958 issue), I checked the d.c. potential across the key. It ran considerably lower than that which is common in most small transmitters today. However, I did not check for an a.c. component. Subsequent checks with the transmitter show an a.c. leakage of 90 volts between one side of the key and a water pipe ground. This voltage does represent a possible shock hazard and one that should have been brought out in the article.

At the moment I can see two solutions. Easiest is grounding the chassis through a .005 μ fd., 600-volt ceramic capacitor. This would establish the desirable r.f. ground without passing appreciable current—and would remove any shock hazard from the transmitter chassis itself. However, I am strongly sold on the desirability of having all equipment in a ham station at "earth ground." The obvious answer is to insert a keying relay (the low priced *Advance* GHA-1C6 VAC should do nicely) and at the moment this is the solution I would recommend. Of course, there is also the possibility of a blocked grid keying system. I'm afraid that in this one—with the best of intentions—I shut the front door on the safety problem but failed to lock the basement window.

JAY STANLEY
Denver, Colorado

We hope that all our readers will observe the proper precautions when dealing with "Muscle Mouse." We would also like to point out that the heater pin connections of the 12BY7A used are 4 and 5 and not 4 and 3 as shown.—Editor.

FREE from HOWARD W. SAMS!...valuable all-steel file cabinets with your purchase of **PHOTOFACT**—
the world's finest TV-Radio Service Data

FREE! FOR REGULAR PHOTOFACT SUBSCRIBERS

You get your File Cabinets FREE if you are a regular subscriber to PHOTOFACT Folders and buy all new Sets as issued each month. Your Folders come to you in special envelopes, each including a "Bonus Certificate." Sixty (60) of these entitle you to a single-drawer File Cabinet ABSOLUTELY FREE...



FREE! FOR PHOTOFACT LIBRARY PURCHASERS

Get FREE File Cabinets as you complete your profit-building PHOTOFACT Library... here's how:



FREE!
Single-Drawer File Cabinet with your purchase of 60 Sets of PHOTOFACT Folders.
Cabinet Worth \$895



FREE!
Two single-drawer File Cabinets with your purchase of 120 Sets of PHOTOFACT Folders.
Cabinets Worth \$1790



FREE!
Three single-drawer File Cabinets with your purchase of 180 Sets of PHOTOFACT Folders.
Cabinets Worth \$2685



FREE!
Four single-drawer File Cabinets with your purchase of 240 Sets of PHOTOFACT Folders.
Cabinets Worth \$3580

NEW EASY-BUY PLAN

It's easy to complete your present PHOTOFACT Library or start a PHOTOFACT Library. Use the EASY-BUY PURCHASE PLAN:

- NO INTEREST
- NO CARRYING CHARGE
- AS LITTLE AS \$10 DOWN
- UP TO 24 MONTHS TO PAY

Get the world's finest TV-Radio Service Data... get FREE File Cabinets with your PHOTOFACT purchases...take advantage of the Easy-Buy Plan. See your Sams Distributor today, or write to Howard W. Sams for full details.



get the full details of the HOWARD W. SAMS money-saving way to build your complete profit-making PHOTOFACT Library!

HOWARD W. SAMS & CO., INC.
2203 E. 46th St., Indianapolis 5, Indiana



Send details on your FREE File Cabinet offer and EASY-BUY Plan.

I'm a Service Technician: full time; part time

My Distributor is: _____

Shop Name: _____

Attn.: _____

Address: _____

City _____ Zone _____ State _____

*They're New...
Smart... Attract Customers..*

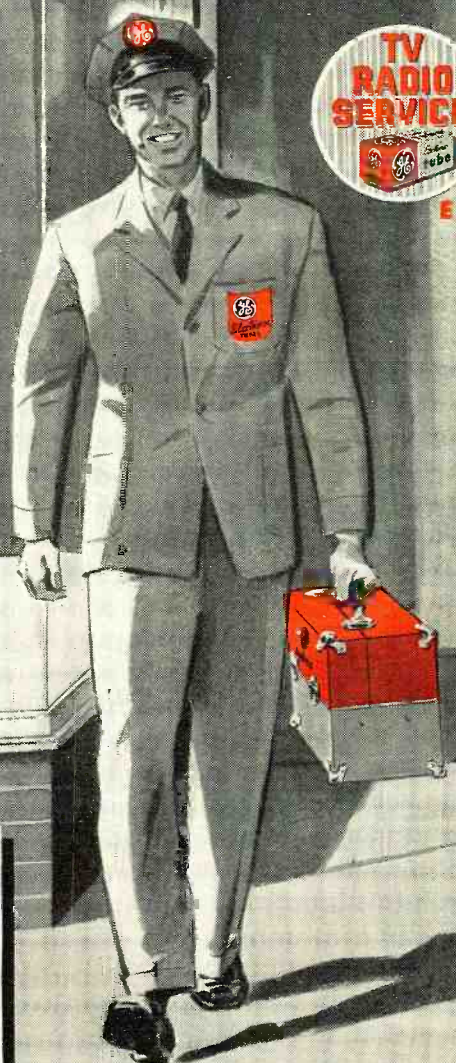

A. ILLUMINATED SIGN-A-RAMA. Visible for blocks. Brightly lit with six flashing lamps. Double-faced, large—48" by 24"—gives top identification to your store or shop. Mounting hardware is included.

B. ILLUMINATED SPECIAL-MESSAGE SIGN. Carries your name, or tells any brief message you select. Ideal for windows or interiors. 37" by 14". Uses two 30-watt bulbs. Kit of letters and numerals is included.

C. DISPLAY BACKDROP. Arrange this handy back-up display to meet your advertising needs. Material is flexible, can be curved or will mount flat. For window trim, walls, or counter fronts. Two 36" x 24" designs per strip.

D. GIANT TUBE CARTON. Eye-arresting... indicates the quality components you install and sell.

E. DOOR, WINDOW DECAL. Neat, attractive, new dry-apply type. 12" diameter.

.. GENERAL ELECTRIC'S COLOR-KEYED SHOP SIGNS

Color-keyed to the G-E tube carton—symbol of quality!



Here is your chance to give your shop-front and windows eye-appeal with "sell". Colors of all eleven new General Electric signs and displays match handsomely the famous G-E tube carton. Quality appearance is keyed to high quality of product—a message every passerby is sure to read.

Attractive and modern, General Electric's color-keyed signs and displays also stand for leadership. They identify your shop as a source for television repairwork done to professional standards, backed by up-to-the-minute facilities.

All your display needs are met by smart new G-E designs—from an eye-catching, easy-to-apply door or window decal, to metal and illuminated outdoor and indoor signs...plus colorful utility items like the electric clock and thermometer.

These brand-new signs and displays are waiting for you now at your General Electric tube distributor's. Ask him how to obtain them! *Distributor Sales, Electronic Components Division, General Electric Company, Owensboro, Kentucky.*

◀ **SERVICE CLOTHING**, smartly styled, also is available. Garments are color-keyed to new G-E signs and displays—give that professional look. Durable, launder easily.

◀ **SERVICE CASES** in three useful sizes—small, medium, and large—match color-theme of General Electric displays. Now you can carry with you neatly, compactly, everything you need for making home service calls!

Progress Is Our Most Important Product

GENERAL ELECTRIC

11-11-102



METAL FLANGE SIGN. A display workhorse. Double-faced. Mount it anywhere! Compact—15" by 12"—handy for building corners, delivery entrances, and other side locations.



ILLUMINATED CLOCK, electric. Both useful and advertises your business. Easily read—16" diameter—with long-life bulbs. Hang on a wall, or mount on a counter (easel is provided).



HANGING METAL SIGN. For shop front or service entrance. Message both sides, plus your nameplate. Large—48" by 36"—easily seen. Hanging hardware is included; lights are available.



COUNTER-WALL-WINDOW SIGN. Illuminated. Use it anywhere in your shop! Wrap-around cover has the attractive display on both sides. 15" by 11½" by 5".



OUTDOOR-INDOOR THERMOMETER. Tells temperature accurately. Every viewer will see your advertising message. Replaceable front. 12" diameter.



METAL TACK-ON SIGN. Narrow, smart dimensions—14" by 42". Fasten against building, or mount as a free-standing display.

straight from the shoulder talk...

A TV Picture Tube Warranty is only as good as the manufacturer who issues it...

You can rely on the

Picture Tube Warranty

of RCA



The manufacturer's warranty is for your protection. An RCA 12-month warranty card is assurance that your replacement picture tube is a genuine RCA Silverama—and that the reputation and integrity of RCA stand behind it. It's well worth while to insist on an RCA Silverama, the same advanced tube used in many of the new '58 TV sets. Often, it will even produce a picture more brilliant, sharper, clearer than your set gave when new! So, if your picture tube should need replacing, be sure you get what you pay for, the best picture tube made—RCA Silverama. After your service dealer installs it, ask him to complete your copy of the warranty card. One comes with every genuine RCA Silverama Picture Tube.

Super-Aluminized  Daylight Clear

RCA Silverama

PICTURE TUBES

RCA Electron Tube Division, Harrison, N. J.

“Just as good” isn't good enough for your TV!



Let's face it! Nothing lasts forever. When you have to pay out good money for a replacement Picture Tube, you're entitled to the best that modern electronics can produce—that's an RCA SILVERAMA. It stands to reason that RCA, with its great laboratories, facilities, and “know-how” produces the finest Picture Tubes money can buy. So, don't let “just as good” tempt you. Remember, RCA Silverama Picture Tubes cost no more than other brand-name aluminized tubes ... they are warranted for one full year, too.

Super-Aluminized  Daylight Clear

RCA Silverama

PICTURE TUBES

RCA Electron Tube Division, Harrison, N. J.

...that makes it easy
for you to sell the #1
picture tube... RCA Silverama

Messages like these appear regularly in TV Guide and other publications, telling millions of TV viewers (many of them your customers) the facts about their all-important picture tube.



RADIO CORPORATION OF AMERICA
Electron Tube Division
Harrison, N. J.

Get into

TELEVISION RADIO-ELECTRONICS



**LEARN ALL 8 PHASES
BY SHOP METHOD**

**OF THE INDUSTRY
HOME TRAINING**

1. Television . . . including Color TV
2. Radio . . . AM, FM
3. Industrial Electronics
4. Communications
5. Sound Recording & Hi-Fidelity
6. Automation
7. FCC License Preparation
8. Radar & Micro Waves

Let National Schools of Los Angeles, a Practical Resident Technical School for over 50 years, train you at home by Shop Method for unlimited opportunities in All phases of TV, Electronics, Radio.

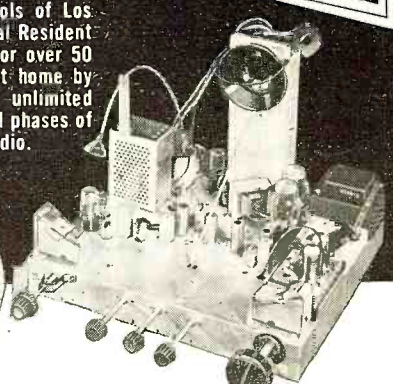

**You get 19 big kits
of equipment!**

GOOD JOBS . . . MORE MONEY SECURITY . . . ALL CAN BE YOURS

YOU are needed in the great modern Television-Electronics industry. Trained technicians are in growing demand, at excellent pay, in sales and service, manufacturing, broadcasting, telecasting, communications, research, and many other important branches of the field. National Schools Master Shop-Method Training, with newly added lessons and equipment prepares you in your spare time right in your own home for these fascinating opportunities. **OUR OUTSTANDING METHOD IS PROVED BY THE SUCCESS OF GRADUATES ALL OVER THE WORLD!**

YOUR TRAINING IS ALL INCLUSIVE

We prepare you for a long list of job opportunities. Thousands of TV and Radio receivers are being sold every day—more than ever before. And, now, Color TV is here. Applications of Electronics in industry—**AUTOMATION**—are growing in tremendous strides. The whole field is alive—opening up new, important jobs rapidly. National Schools complete training program qualifies you in all phases of the industry.

YOU EARN WHILE YOU LEARN

Many students pay for their entire training—and more—with spare time earning. We'll show you how you can, too! Early in your course you receive material that shows you how to earn extra money servicing TV and Radio receivers, appliances, etc., for friends and acquaintances.

YOU GET EVERYTHING YOU NEED

Clear, profusely illustrated lessons, shop-tested manuals, modern circuit diagrams, practical job projects—all the valuable equipment shown above—many other materials and services—consultation privilege with our qualified staff, and Graduate Employment Service. **EVERYTHING YOU NEED** for outstanding success in Electronics.

**INDUSTRY NEEDS YOU. NATIONAL SCHOOLS
WILL TRAIN YOU. SEND FOR FACTS TODAY
NO OBLIGATION.**

YOU LEARN BY SHOP METHOD . . . you do servicing, circuit analysis, and do over 100 down-to-earth experiments. You build a Superhet Receiver and a modern TV Receiver, from the ground up, including a new, big screen picture tube. You also receive a professional, factory-made **MULTI-TESTER**. All of this standard equipment is yours to keep . . . at just one low tuition.

RESIDENT TRAINING AT LOS ANGELES

If you wish to take your training in our Resident School at Los Angeles, the world's TV capital, start **NOW** in our big, modern Shops, Labs and Radio-TV Studios. Here you work with latest Electronic equipment—professionally installed—finest, most complete facilities offered by any school. Expert, friendly instructors. Personal attention. Graduate Employment Service. Help in finding home near school—and part time job while you learn. Check box in coupon for full information.

Approved for
GI Training



NATIONAL SCHOOLS

LOS ANGELES 37, CALIF.

**FREE!
VALUABLE BOOK
& SAMPLE LESSON
—Just Send
Coupon!**

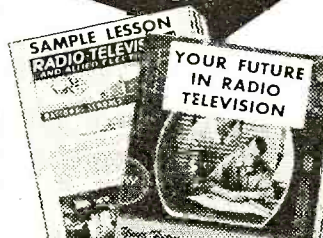

NATIONAL SCHOOLS

TECHNICAL TRADE TRAINING SINCE 1905
LOS ANGELES 37; CALIFORNIA

GET FAST SERVICE—MAIL NOW TO

NATIONAL SCHOOLS, DEPT. RH-58

4000 S. FIGUEROA ST. LOS ANGELES 37, CALIF.

Rush free TV-Radio "Opportunity" Book and sample lesson. No salesman will call.

NAME _____ AGE _____

ADDRESS _____

CITY _____ ZONE _____ STATE _____

Check if interested ONLY in Resident School training at Los Angeles.
VETERANS Give date of Discharge _____

the **NEW** **PEERLESS**
TRANSFORMER
CATALOG

Now available free to audio
designers and builders



This new 12-page catalog was published for the use of both professional and hobbyist designers and builders of high fidelity, broadcast, and recording equipment. It provides specifications, performance curves, application data, and prices on transformers representing the most advanced developments in the science of audio transformer design. Power, input, output, and impedance-matching transformers are all shown.

**Typical High-Level
Output Transformer**

Model #S-271 is one of the Peerless 20-20 Plus group, which indicates a frequency range greater than 20-20,000 cps. Frequency response is ± 1 db; 10-100,000 cps. Insertion loss is 0.3 db. Maximum level, +49 dbm (80 watts). Primary impedance at 5000 ohms C.T. and 1250 ohms C.T.: Secondary 1, 4, 8, 16 ohms.

WRITE FOR FREE CATALOG

Peerless Electrical Products
A Division of Altec Lansing
Corporation, Dept. 5T
6920 S. McKinley Avenue
Los Angeles 1, Calif.



PEERLESS
Electrical Products

A DIVISION OF



9356 Santa Monica Blvd., Beverly Hills, Calif.

12-14A

Within the Industry

DON ROSS has been appointed to the newly created post of national field sales manager of *Pilot Radio Corporation*.

In his new position, he will assist the vice-president in charge of sales. Mr. Ross joined the firm as Mid-West sales manager in 1956.



A sales executive with more than fifteen years of experience in sales and sales development, Mr. Ross has been associated with *Bendix Aviation*, *General Electric Company*, and *Motorola*.

* * *

WESCON has selected William C. Estler, public relations counselor of Palo Alto, Calif. and *General Public Relations, Inc.*, Los Angeles, as public relations counsel for the Western Electronic Show and Convention.

They will work closely with an electronics industry public relations committee chairmanned by Elliot Lewis of the *Ramo-Wooldridge Corp.*, Los Angeles, Calif.

* * *

KENNETH G. BUCKLIN has been appointed manager, engineering, receiving tube operations, *RCA* electron tube division.

Mr. Bucklin joined the division in 1933 after working for two years as an engineer with *DeForest Radio Company*. In 1939 he became manager, design engineering. Between 1942 and 1953 he served in several merchandising and administrative positions. Mr. Bucklin was appointed manager for receiving tube and transistor marketing in 1953 and a year later was made manager, receiving tube marketing.



In 1952 Mr. Bucklin received the company's "Victor" Award of Merit, the firm's highest citation for salaried employees.

* * *

RCA's first David Sarnoff Outstanding Achievement Awards in Science and Engineering will be presented to Albert Rose of the technical staff of the laboratories, and David K. Barton, engineering staff, defense electronic products.

The two awards, to be made annually to the outstanding scientist and the outstanding engineer of the *Radio Corporation of America*, were established in September, 1956 to commemorate the fiftieth anniversary in radio of Brig.

General David Sarnoff, Chairman of the Board of the company. Each award consists of a gold medal and a citation.

Dr. Rose is being cited "for basic contributions to the understanding and utilization of photoelectronic phenomena" and Mr. Barton's citation specifies "for important contributions to precise tracking radars."

* * *

LEWIS J. SHIOLENO has been named general manager of the electronics division, *Erie Resistor Corporation*.

Prior to his appointment, Mr. Shioleno was superintendent of manufacturing for the electro-mechanical division. His new duties encompass all responsibility of sales, engineering, and production for the electronics division.



He is a graduate of the University of Notre Dame and joined the company in May, 1950.

* * *

HEATH COMPANY, a subsidiary of *Daystrom, Inc.*, has moved its entire manufacturing operation to a new 140,000 square foot building. The mailing address remains Benton Harbor, Michigan, but the new phone number is Yukon 3-3961 . . . **CBS-HYTRON**, electron tube division of the *Columbia Broadcasting System*, has made arrangements to sell its plant at Kalamazoo, Michigan, to the **BRUNSWICK-BALKE-COLLENDER COMPANY** . . .

Headquarters of the special tube operations of **SYLVANIA ELECTRIC PRODUCTS INC.** have been transferred to Williamsport, Pa., from Woburn, Mass. Concurrently, it was announced that the components laboratories in Mountain View, Calif., will become a part of special tube operations . . . **RADIO INDUSTRIES, INC.** has transferred to its new plant at 666 Garland Place, Des Plaines, Ill. the manufacture of disc capacitors and feedthroughs. The executive and sales offices will be moved later from the Chicago Ravenswood plant to the new, modern, one-story building. The Chicago plant will continue to produce transformers and coils on an expanded basis . . . All manufacturing operations of **SIMPLEX EQUIPMENT CORPORATION**, a subsidiary of *General Precision Laboratory, Inc.*, have been suspended. The parent company's plant in Pleasantville, N. Y., will take over the manufacturing . . . Two more Chicago firms have announced purchase of plant sites in the new Centex Industrial Park, located in Elk Grove Village northwest of Chicago. **SOLA ELECTRIC COMPANY** has

build your **PRESTIGE** and **PROFITS** with

CHANNEL MASTER ACCESSORIES

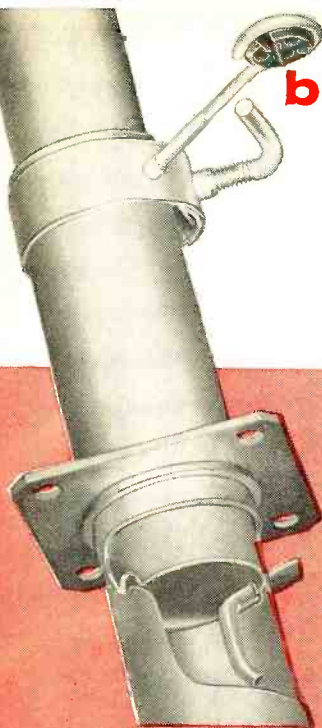

Channel Master masting is made of finest quality high carbon steel

CHANNEL MASTER REDUCES ALL MASTING PRICES!

Only Channel Master can bring you top quality masting at the lowest possible prices ... because *only* Channel Master manufactures telescoping masts in its own steel tubing mill.

Prices for Channel Master telescoping and straight-length masting are the lowest on the market.

Telescoping masting line now fully assembled — and costs far less than previous non-assembled masts.

Cut your Costs . . . Boost your Profits — Call your Channel Master distributor now.

Cash-In On Channel Master's Consumer Popularity! Feature these top-quality accessories bearing the nationally advertised Channel Master name.



MOUNTS



COUPLERS



STANDOUT
INSULATORS



GUY WIRE



Only
**CHANNEL
MASTER**
offers
you this

"SUPERMARKET" VARIETY of TV WIRE

Your choice of 37 models... 14 different types... of VHF, UHF, and Rotor Wires

- NEW! JUMBO TRANSMISSION WIRE — extra heavy-duty 170/18 and 155/20 wire.
- NEW! "SUPER FOAM" TRANSMISSION WIRE — superb-quality foam poly insulation.

When you feature Channel Master you have the widest selection of TV wire ... plus premium quality for longer life and better performance — at no extra cost. That's why ...

**"Live Wire" Dealers
use Channel Master Exclusively**

Copyright 1958 Channel Master Corp.

CHANNEL MASTER CORP.
ELLENVILLE, N. Y.
WORLD'S LARGEST MANUFACTURER OF TV ANTENNAS AND ACCESSORIES



Seeing Double?

**SURE... THEY LOOK ALIKE BECAUSE
THEY ARE EXACTLY ALIKE**

Each Merit product of the same type is exactly the same as another—both in construction and appearance.

COMPARE IT WITH MERIT

Take a Merit product off the shelf. Compare it with any other similar product on the market. You'll find Merit is superior!

COMPARE IT WITH MERIT

Only Merit live tests its products to insure uniform quality.



MERIT

MERIT COIL AND TRANSFORMER CORP
MERIT PLAZA • HOLLYWOOD, FLORIDA

an *Metalcraft Inc.*, chairman; Technical Program—Dr. R. C. Hansen, *Hughes Aircraft Co.*, chairman; Visitors' Housing—J. M. Loge, *J. M. Loge Sound Engineers*, chairman; and Show Advisory—Thomas A. Lynch, *Radio Products Sales, Inc.*, chairman.

Also officiating at the early planning meeting were Walter E. Peterson, director of the electronics division, *Radioplane Co.*, who is convention director, Hugh P. Moore, head of *Lerco Electronics Corp.*, show director, and Don Larson, business manager.

ERIE RESISTOR CORPORATION has announced the purchase of the assets for cash of **HUPP INSTRUMENT COMPANY**, Los Angeles, Calif. The acquisition includes the assets, designs, patents, trademarks, and the name of the West Coast instrument manufacturer. The firm will be combined with the Hawthorne, California, factory of the parent company's Electro-Mechanical Division which will direct marketing and manufacturing of these electronic instruments . . . **PIC DESIGN CORPORATION** has made known the acquisition of a precision tool component line from **VON INDUSTRIES, INC.**, Mineola, N. Y. . . . A. W. Haydon has started a new enterprise known as **HAYDON INSTRUMENT COMPANY** to design and manufacture new proprietary electro-mechanical devices. The firm is located at 156 W. Liberty Street, Waterbury 20, Conn. . . . The formation and move of the **DIGITRAN COMPANY** into new headquarters at 45 W. Union St., Pasadena, Calif., has been announced. Formerly known as the *Anatran Division* of *Endevco Corp.*, the new company will continue its development and expansion as a maker of electrical read-out mechanical counters and digital motors for computers, automation, and systems designs . . . Broadcaster Bill Leonard has recently organized the firm of **HANOVER ELECTRONICS, INC.**, 126 E. 37th St., New York, N. Y. The company will publish or manufacture items of special interest to amateur radio operators, short-wave listeners, and experimenters . . . **SYLVANIA ELECTRIC PRODUCTS INC.** announces a change in the title of its radio and television division. Henceforth it will be known as **SYLVANIA HOME ELECTRONICS**, a division of the parent organization. Marion E. Pettegrew, senior vice-president of the company, will continue to have over-all responsibility for the division . . . **PACIFIC MERCURY TELEVISION MANUFACTURING CORP.**, Sepulveda, Calif., has acquired **TELEMETERING CORPORATION OF AMERICA**, Los Angeles, Calif. The company will function as a wholly owned subsidiary of the parent organization . . . Formation of the **MID-SOUTH TECHNICAL INSTITUTE** offering basic and advanced training in the electronics and other fields has been announced. The institute has taken over the facilities and staff of **COMMERCIAL TRADES INSTITUTE** and will operate on a non-profit basis. The

(Continued on page 106)

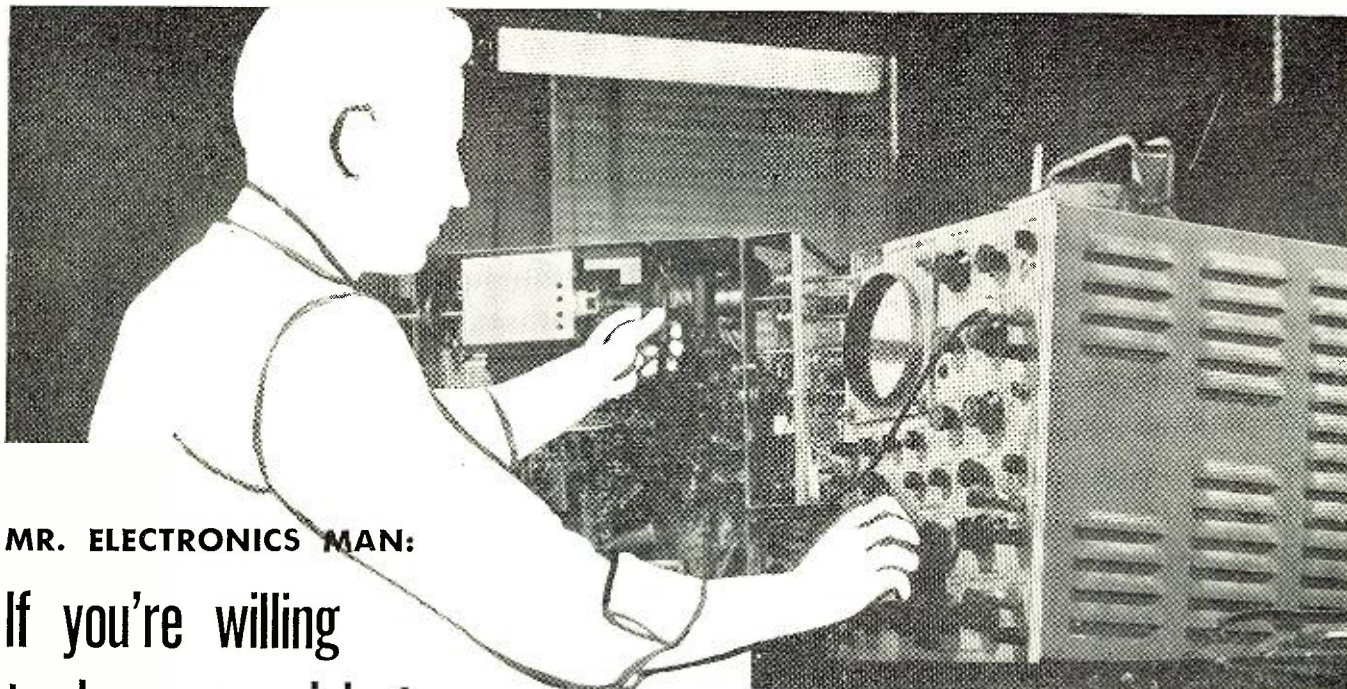

MR. ELECTRONICS MAN:

**If you're willing
to lose your job tomorrow
to a technically-trained man,
turn the page, mister**

But if you're interested in an honest-to-goodness career in the vigorous young electronics industry, here's how you can step ahead of job-competition, move up to a better job, earn more money, and be sure of holding your technical job, even if the brass is firing instead of hiring.

The "how" is advanced, professional home study training in Electronic Engineering Technology including SERVO-MECHANISMS; COMPUTERS; RADAR; AUTOMATION; AERONAUTICAL ELECTRONICS; BROADCASTING; COMMUNICATIONS AND MANUFACTURING, and the ELECTRONIC PRINCIPLES ASSOCIATED WITH GUIDED MISSILES, TELEMETERING, ASTRONAUTICS, and INSTRUMENTATION. You don't have to be a college graduate. You *do* have to be willing to study—at home. You can do it while holding down a full-time job. Thousands have. Since 1927 CREI has provided alert young men with the technical knowledge that leads to more responsibility, more job security, more money. And CREI has constantly kept pace with the rapid expansion and progress in electronic achievement.

Remember this: CREI starts with fundamentals and takes you along at your own speed. You are not held back by a class, not pushed to keep up with others. You set your own pace. CREI instructors guide you through the lesson material and *grade* your written work personally. You master the fundamentals, then get into more advanced phases of electronics engineering principles and practice. Finally you may elect training in highly specialized principles of electronic engineering technology as applied to guided missiles, servomechanisms, radar com-

puters, telemetering, automation, instrumentation and other applications.

How good is CREI training? Ask an electronics engineer. Ask a radio station engineer. CREI courses are accredited by the Engineers' Council for Professional Development; CREI is a member of the National Council of Technical Schools.

Look at this partial listing of organizations that recommend CREI training for their own personnel: United Air Lines, Canadian Broadcasting Corp., Trans-Canada Airlines, Douglas Aircraft Co., The Martin Co., Columbia Broadcasting System, All-American Cables and Radio, Inc., Gates Radio Co., Canadair Ltd., Federal Electric Corp., and U. S. Information Agency (Voice of America).

What's the next step? *Certainly get more information than we can cram into one page. Fill out and mail the coupon below today, or write Capitol Radio Engineering Institute, Dept. 115-E, 3224 16th St., N.W., Washington 10, D. C.*

CREI ALSO OFFERS RESIDENCE TRAINING at the same high technical level in Washington, D. C. Classes start at regular intervals. Qualified residence school graduates earn degree, "Associate in Applied Science." Check coupon if you prefer residence study.

VETERANS: If eligible for training under the new G.I. Bill of Rights, check the coupon for full information.

MAIL THIS COUPON FOR FREE BOOKLET!

CAPITOL RADIO ENGINEERING INSTITUTE

ECPD Accredited Technical Institute Curricula • Founded 1927

Dept. 115E 3224 16th St., N.W., Washington 10, D. C.

Please send me your course outline and FREE illustrated Booklet "Your Future in the New World of Electronics" . . . describing opportunities and CREI home study courses in Electronics Engineering Technology.

- CHECK FIELD OF GREATEST INTEREST } Radar, Servo and Computer Engineering Technology
 Electronic Engineering Technology
 Broadcast (AM, FM, TV) Engineering Technology
 Television Engineering Technology
 Aeronautical Electronic Engineering Technology **13**

Name.....Age.....

Street.....

City.....Zone.....State.....

Check: Home Study Residence School Korean Veteran

NOT FOR BEGINNERS. If you have the equivalent of a high school education, and are good at mathematics, if you have some electronics experience (advanced amateur, experimenting, military or industrial),—and realize the need of high-level technical knowledge to make good in the better electronic jobs—you can qualify for CREI home study training. (Electronics experience is not required for admission to CREI Residence School.) Please fill in the following information:

EMPLOYED BY.....

TYPE OF PRESENT WORK.....

EDUCATION: YEARS HIGH SCHOOL.....

YEARS COLLEGE.....

ELECTRONICS EXPERIENCE.....

Can You Hear

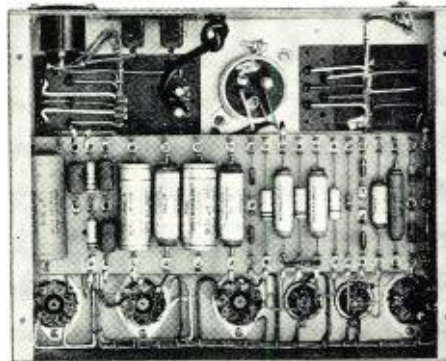

UNDERSIDE VIEW OF POWER AMPLIFIER

A Decimal Point



REMOTE CONTROL PREAMPLIFIER



Listen to a Leak "Point One" Amplifier! You will hear more realistic, satisfying music... and enjoy it without fatigue, because the Leak keeps harmonic distortion at the lowest figure ever achieved... 1/10 of one per cent (0.1%) at rated power!

3 NEW HIGH POWER LEAK AMPLIFIERS
... 12, 25, 50 watts ... all at 1/10 of 1% distortion

The aim in producing these amplifiers is to provide the benefits of professional components and workmanship for use in your high fidelity system. All three feature the incomparable Leak triple loop negative feedback circuit, which incorporates the finest components... and great skill in testing and assembly. All components are utilized well below their maximum ratings to insure great stability and long life. Power ratings are very conservative. In actual fact, each amplifier delivers power far beyond its stated wattage, and still maintains negligible distortion. Leak craftsmanship is traditionally outstanding. Turn any Leak amplifier upside down and compare the circuitry and workmanship with that of any other make. Do this at your dealer and judge for yourself.

2 NEW LEAK PREAMPLIFIERS... "POINT ONE PLUS" & VARISLOPE III
... built specifically and only for the Leak Power Amplifiers!

The handsome, compact look of these new preamplifiers is matched by their exceptional versatility. For example, exclusive tape recording and playback jacks on front and rear panels facilitate portable, as well as permanent, tape recorder installations. The new "Point One Plus" features playback characteristics covering all records ever made! The inputs for tuner, tape and phono cartridge each have their own balancing controls. You simply could not buy more preamplifier for the money. The great new Varislope III preamplifier provides all the advanced features of the "Point One Plus" and the exclusive, *infinitely variable* Leak Slope Control. Records which may sound harsh or shrill can be controlled to remove distortion while keeping all the musical content.



Leak amplifiers are moderately priced. Most fine systems in large homes use the \$164.50 (25 watt) combination.*

Choose from six Leak combinations:

AMPLIFIERS		PREAMPLIFIERS		COMBINATIONS	
	TL/12 PLUS An outstanding 12 watt 0.1% amplifier built to every superior Leak standard. \$89.00.		TL/25 PLUS 25 watts performance more than adequate for average interiors. \$109.50.		VARISLOPE \$168.00 POINT ONE \$144.00
	TL/50 PLUS Full 50 watts output at 1/10 of 1% (0.1%) harmonic distortion. \$149.00.		"POINT ONE PLUS" Full complement of controls for records and tone. Inputs for tuner, tape and phono. \$55.00.		VARISLOPE \$188.50 POINT ONE \$164.50*
	VARISLOPE III All "Point One" features plus two magnetic inputs, rumble filter, Leak Slope Control. \$79.00.				VARISLOPE \$228.00 POINT ONE \$204.00



For free literature and a list of dealers, write Dept. L. E.-48 BRITISH INDUSTRIES CORP., PORT WASHINGTON, N. Y.



**Latest Information
on the Electronic Industry**

Spot News

By RADIO & TV NEWS'
WASHINGTON EDITOR

TOLL-TELEVISION TESTS OFFICIALLY STALLED UNTIL AFTER CONGRESS ADJOURNS— With the solid approval of a resolution by the Senate Interstate and Foreign Commerce Committee asking the FCC not to authorize on-the-air subscription-TV without a definite green light from Congress, the Commission's plan to approve experimental tests in the early Spring found itself stranded . . . As a result, the Commissioners decided that they would not do anything about toll-TV applications until 30 days after Congress goes home . . . Commenting on the Senate resolution, Senator Strom Thurmond (South Carolina) said that the subscription-TV issue involves a broad policy that should be resolved only by Congress and not left to . . . "the whim of a regulatory agency."

RADIO AND TELEVISION CONELRAD ATTENTION SIGNALS ARE TO BE USED FOR EMERGENCY STORM AND FLOOD WARNINGS— Plans are now being pushed by the Weather Bureau to utilize the nationwide emergency alerting system to help minimize the loss of life and property due to unforeseen natural disasters such as hurricanes, tornadoes, and flash floods. Such use of Conelrad was made possible following a recent order issued by the FCC which authorized this special application of existing national defense alerting procedures . . . The Weather Bureau emphasized that the facilities would not be used for forecasts but only in case the weather took an unexpected and unforecast turn for the worse . . . in other words . . . the new service will supplement, not replace, existing methods of disseminating weather information.

WIDE-SCREEN TV PICTURE TECHNIQUE INVENTED—A television system, known as the Scanscope, in which the aspect ratio can be changed from the conventional 4 x 3 format to an 8 x 3 presentation has been invented. Advantages are said to be analogous to wide-screen motion pictures . . . In the process, a lens squeezes the image on the camera focal plane, from which it is transmitted with the required bandwidth. Then the image is "unsqueezed" electronically in the monitor. It is felt that the new technique will have wide applications in the military and closed-circuit fields, since it provides twice the information with essentially the same equipment. In the documentary and entertainment fields, it is believed, the new approach can provide the same advantages that wide-screen movies afford.

LONG-RANGE MISSILE-DETECTOR RADARS DESIGNED FOR AIR FORCE—Long-range radars required to detect and track enemy ballistic missiles have been developed in the laboratories of the Air Research and Development Command and of universities and industry . . . In one radar, an antenna 178 feet high and 110 feet across is involved . . . Another, the Millstone Hill radar, developed for the Air Force by the Lincoln Labs of MIT, employs klystron tubes that are eleven feet high and a parabolic reflector 84 feet in diameter, mounted on a concrete and steel tower ninety feet high. The rotating portion of the antenna structure weighs ninety tons . . . With a horizontal rotating capability of 360 degrees and a vertical elevating capacity of 90 degrees, the antenna can sweep the sky.

DIGITAL COMPUTERS NOW AVAILABLE TO PROCESS PICTURE INFORMATION—With scanning and display equipment engineered by the Bureau of Standards, it is now possible to use a computer to convert pictures into digital form suitable for input; the information is then processed according to some pre-arranged routine and the results are displayed as a visual output . . . The technique is expected to increase knowledge of the possible applications of high-speed electronic computers for processing information that occurs in the form of pictures, diagrams, or other graphical configurations.

NUMBER OF OPERATING TV STATIONS MOVES TO 507—At press time the FCC announced that there were 507 television stations in operation; 422 on v.h.f., and 85 on u.h.f. . . . New station actions include grants to Carl Bloomquist, Hibbing, Minn., for channel 13 (192-198 mc.) operating on 10.7 kw; Marvin Kratter (Golden State Telecasting Co.), San Francisco, Calif., for channel 38 (614-620 mc.), operating on 16.6 kw; Minneonto TV, Inc., International Falls, Minn., for channel 11 (198-204 mc.), operating on 1.59 kw; and Cache Valley Broadcasting Co., Logan, Utah, for channel 12 (204-210 mc.) on a power of 2.95 kw. -50-

GUIDE AUTRONIC-EYE[®]

**TRAINING COURSES
MEAN MORE
BUSINESS FOR YOU!**



Courses for experienced service technicians provide latest repair information—enable you to do the job faster and more efficiently.

Quick, accurate circuit diagnosis and repair to factory specifications boosts your profits. That's why so many qualified auto technicians attend these Guide training courses at no cost other than transportation and living expenses.

The Guide Lamp diploma, awarded only to those who successfully complete the course, is proof that you're equipped to give more and better service to more people—and that means business.

If you're an auto radio service dealer, come yourself, or send your technicians. There's one of 30 GM Training Centers near you. Apply through your local United Motors Service Division Distributor or write

GUIDE LAMP DIVISION • GENERAL MOTORS CORP. • ANDERSON, INDIANA

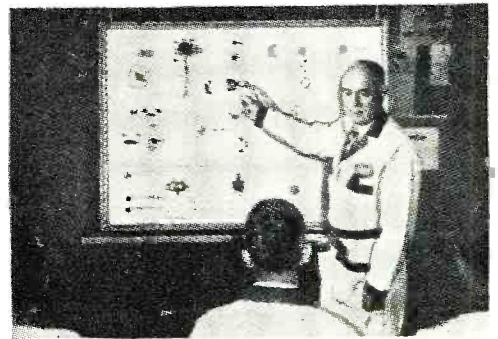

Jumbo-size operational panel of Guide's Autronic-Eye Circuit puts all parts out front for better, more efficient instruction.



Thirty modern GM Training Centers give newest equipment and latest service techniques. There's one nearby... no matter where you live.



**BLINKY MEANS
BUSINESS!**

the experts say... in High Fidelity the best buys are **EICO**®

EICO
KITS and WIRED

BETTER ENGINEERING Since 1945 EICO has pioneered the concept of test instruments in easy-to-build kit form — has become world-famous for laboratory-precision instruments at low cost. Now EICO is applying its vast experience to the creative engineering of *high fidelity*. Result: high praise from such authorities as Canby of AUDIO, Marshall of AUDIOCRAFT, Holt of HIGH FIDELITY, Fantel of POPULAR ELECTRONICS, Stocklin of RADIO TV NEWS, etc. — as well as from the critical professional engineers in the field.†

SAVE 50% Mass purchasing, and a price policy deliberately aimed to encourage mass sales, make this possible.

EASY INSTRUCTIONS You need no previous technical or assembly experience to build any EICO kit — the instructions are simple, step-by-step, "beginner-tested."

DOUBLE 5-WAY GUARANTEE Both EICO, and your neighborhood distributor, guarantee the parts, instructions, performance... as well as *lifetime* service and calibration at nominal cost... for any EICO kit or wired unit.

BEFORE YOU BUY, COMPARE At any of 1200 neighborhood EICO distributors coast to coast, you may examine and listen to any EICO component. Compare *critically* with equipment several times the EICO cost — then *you* judge. You'll see why the experts recommend EICO, kit or wired, as best buy.

† Thousands of unsolicited testimonials on file.

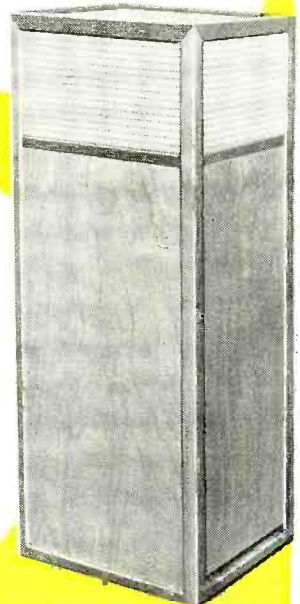

HFS2
Speaker System



HFT90 FM Tuner
with "eye-tronic" tuning



HF61 Preamplifier



HF60, HF50 Power Amplifiers



HFS2—Speaker System: Uniform loading & natural bass 30-200 cps achieved via slot-loaded split conical bass horn of 12-ft path. Middles & lower highs from front side of 8½" cone, edge-damped & stiffened for smooth uncolored response. Suspensionless, distortionless spike-shaped super-tweeter radiates *omni-directionally*. Flat 45-20,000 cps, useful to 30 cps. 16 ohms. HWD: 36", 15¼", 11½". "... rates as excellent... unusually musical... really non-directional" — Canby, AUDIO. "Very impressive" — Marshall (AUDIOCRAFT). Walnut or Mahogany, \$139.95. Blonde, \$144.95.

HFT90 FM Tuner equals or surpasses wired tuners up to 3X its cost. New, pre-wired, pre-aligned, temperature-compensated "front end"—drift-free. Sensitivity, 1.5 uv for 20 db quieting, is 6X that of other kit tuners. DM-70 traveling tuning eye. Response 20-20,000 cps ± 1 db. Cathode follower & multiplex outputs. Kit \$39.95*. Wired \$65.95*. Cover \$3.95. *Less cover, excise tax incl.

HF61A Preamplifier, providing the most complete control & switching facilities, and the finest design, offered in a kit preamplifier, "... rivals the most expensive preamps... is an example of high engineering skill which achieves fine performance with simple means and low cost."—Joseph Marshall, AUDIOCRAFT. HF61A Kit \$24.95, Wired \$37.95, HF61 (with Power Supply) Kit \$29.95. Wired \$44.95.

HF60 60-Watt Ultra Linear Power Amplifier, with Aco TO-330 Output Transformer, provides wide bandwidth, virtually absolute stability and flawless transient response. "... is one of the best-performing amplifiers extant; it is obviously an excellent buy."—AUDIOCRAFT Kit Report. Kit \$72.95. Wired \$99.95. Matching Cover E-2 \$4.50.

HF50 50-Watt Ultra-Linear Power Amplifier with extremely high quality Chicago Standard Output Transformer. Identical in every other respect to HF60 and same specifications up to 50 watts. Kit \$57.95. Wired \$87.95. Matching Cover E-2 \$4.50.

HF30 30-Watt Power Amplifier employs 4-EL84 high power sensitivity output tubes in push-pull parallel, permits Williamson circuit with large feedback & high stability. 2-EZ81 full-wave rectifiers for highly reliable power supply. Unmatched value in medium-power professional amplifiers. Kit \$39.95. Wired \$62.95. Matching Cover E-4 \$3.95.

HF-32 30-Watt Integrated Amplifier Kit \$57.95. Wired \$89.95.

HF52 50-Watt Integrated Amplifier with complete "front end" facilities and Chicago Standard Output Transformer. Ultra-Linear power amplifier essentially identical to HF50. The least expensive means to the highest audio quality resulting from distortion-free high power, virtually absolute stability, flawless transient response and "front end" versatility. Kit \$69.95. Wired \$109.95. Matching Cover E-1 \$4.50.

HF20 20-Watt Integrated Amplifier, complete with finest preamp-control facilities, excellent output transformer that handles 34 watts peak power, plus a full Ultra-Linear Williamson power amplifier circuit. Highly praised by purchasers, it is established as the outstanding value in amplifiers of this class. Kit \$49.95. Wired \$79.95. Matching Cover E-1 \$4.50.

Prices 5% higher in the West

HF12 12-Watt Integrated Amplifier, absolutely free of "gimmicks", provides complete "front end" facilities & true fidelity performance of such excellence that we can recommend it for any medium-power high fidelity application. Two HF12's are excellent for stereo, each connecting directly to a tape head with no other electronic equipment required. Kit \$34.95. Wired \$57.95.

HFS1 Two-Way Speaker System, complete with factory-built cabinet. Jensen 8" woofer, matching Jensen compression-driver exponential horn tweeter. Smooth clean bass; crisp extended highs. 70-12,000 cps ± 6 db. Capacity 25 w. Impedance 8 ohms. HWD: 11" x 23" x 9". Wiring time 15 min. Price \$39.95.

THE HI-FI EXPERTS SAY:

"For those who have been looking for a well-engineered yet inexpensive power amplifier, the newly-released EICO Model HF20 unit might offer a simple solution to their problem. Not only does this unit provide 20 watts of power but the circuit incorporates a preamplifier and a variety of controls on a single chassis."

William A. Stocklin, Editor, RADIO TV NEWS

"The new EICO 'standard' speaker system... produces sound that to my musical ears rates as excellent, from high top to clean low bottom."

Edward Tatnall Canby, AUDIO Magazine

Fill out coupon on other side for FREE CATALOG



HF52, HF20
Integrated Amplifiers



HF12 Integrated Amplifier



HF30 Power Amplifier

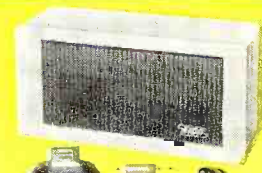

HFS1
Speaker System



33-00 Northern Boulevard, L. I. C. 1, N. Y.
Over 1 Million EICO instruments in use the world over.

© 1958

the specs prove it . . .
your **BEST BUY** is

TEICO®

for COLOR & Monochrome TV servicing

FREE CATALOG

shows you **HOW TO SAVE 50%**
on 50 models of top quality
professional test equipment.
MAIL COUPON NOW!



NEW!
TV-FM SWEEP
GENERATOR &
MARKER #368

KIT \$69⁹⁵ WIRED \$119⁹⁵

Entirely electronic sweep circuit (no mechanical devices) with accurately-biased inductor for excellent linearity. Extremely flat RF output; new AGC circuit automatically adjusts osc. for max. output on each band with min. ampl. variations. Exceptional tuning accuracy: edge-lit hairlines eliminate parallax. Sweep Osc. Range 3-216 mc in 5 fund. bands. Variable Marker Range 2-75 mc in 3 fund. bands; 60-225 mc on harmonic band. 4.5 mc Xtal Marker Osc., xtal supplied. Ext. Marker provision. Sweep Width 0-3 mc lowest max. deviation to 0-30 mc highest max. dev. 2-way blanking. Narrow range phasing. Attenuators: Marker Size, RF Fine, RF Coarse (4-step decade). Cables: output, scope horiz., scope vertical. Deep-etched satin aluminum panel; rugged grey wrinkle steel cabinet.

**NEW! RF
SIGNAL GENERATOR
#324**

KIT \$26⁹⁵ WIRED \$39⁹⁵



150 kc to 435 mc with ONE generator! Better value than generators selling at 2 or 3 times its cost! Ideal for IF-RF alignment, signal tracing & trouble-shooting of TV, FM, AM sets; marker gen.; 400 cps audio testing; lab. work. 6 fund. ranges: 150-400 kc, 400-1200 kc, 1.2-3.5 mc, 3.5-11 mc, 11-37 mc, 37-145 mc; 1 harmonic band 111-435 mc. Freq. accurate to $\pm 1.5\%$; 6:1 vernier tuning & excellent spread at most important alignment freqs. Etched tuning dial, plexiglass windows, edge-lit hairlines. Colpitts RF osc. directly plate-modulated by K-follower for improved mod. Variable depth of int. mod. 0-50% by 400 cps Colpitts osc. Variable gain ext. amplifier: only 3.0 v needed for 30% mod. Turret-mounted coils slug-tuned for max. accuracy. Fine & Coarse (3-step) RF attenuators. RF output 100,000 uv; AF sine wave output to 10 v. 50-ohm output Z. 5-way jack-top binding posts for AF in/out; coaxial connector & shielded cable for RF out. 12AU7, 12AV7, selenium rectifier; xmfr-operated. Deep-etched satin aluminum panel; rugged grey wrinkle steel cabinet.

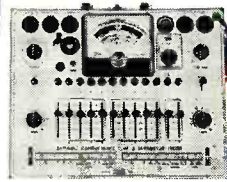

**NEW! DYNAMIC
CONDUCTANCE
TUBE & TRANSISTOR
TESTER #666**
KIT \$69⁹⁵ WIRED \$109⁹⁵

COMPLETE with steel cover and handle.

SPEED, ease, unexcelled accuracy & thoroughness. Tests all receiving tubes (and picture tubes with adapter). Composite indication of Gm, Gp & peak emission. Simultaneous set of any 1 of 4 combinations of 3 plate voltages, 3 screen voltages, 3 ranges of continuously variable grid voltage (with 5% accurate pot). New series-string voltages: for 600, 450, 300 ma types. Sensitive 200 ua meter. 5 ranges meter sensitivity (1% shunts & 5% pot). 10 SIX-position lever switches; freepoint connection of each tube pin. 10 pushbuttons: rapid insert of any tube element in leakage test circuit & speedy sel. of individual sections of multi-section tubes in merit tests. Direct-reading of inter-element leakage in ohms. New gear-driven rollehart. Checks n-p-n & p-n-p transistors: separate meter readings of collector leakage current & Beta using internal dc power supply. Deep-etched satin aluminum panel; rugged grey wrinkle steel cabinet. CRA Adapter \$4.50

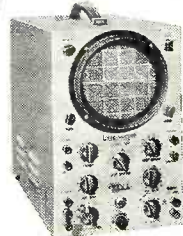

NEW!
**COLOR
and Monochrome
DC to 5 MC LAB & TV
5" OSCILLOSCOPE
#460**

KIT \$79⁹⁵ WIRED \$129⁵⁰

• Features DC Amplifiers!

Flat from DC-4.5 mc, usable to 10 mc. VERT. AMPL.: sens. 25 rms mv/in; input Z 3 meg; direct-coupled & push-pull thruout; K-follower coupling bet. stages; 4-step freq-compensated attenuator up to 1000:1. SWEEP: perfectly linear 10 cps-100 kc (ext. cap. for range to 1 cps); pre-set TV V&H positions; auto. sync. ampl. & lim. PLUS: direct or cap. coupling; bal. or unbal. inputs; edge-lit engraved lucite graph screen; dimmer; filter; bezel fits std photo equipt. High intensity trace CRT. 0.06 usec rise time. Push-pull hor. ampl., flat to 400 kc, sens. 0.6 rms mv/in. Built-in volt. calib. Z-axis mod. Sawtooth & 60 cps outputs. Astig. control. Retrace blanking. Phasing control.



**NEW! PEAK-to-PEAK
VTVM #232 & UNI-
PROBE (pat. pend.)**

KIT \$29⁹⁵ WIRED \$49⁹⁵

Half-turn of probe tip selects DC or AC-Ohms.

Uni-Probe - exclusive with EICO - only 1 probe performs all functions!

Latest circuitry, high sensitivity & precision, wide ranges & versatility. Calibration without removing from cabinet. New balanced bridge circuit. High Z input for negligible loading. 4 1/2" meter, can't burn-out circuit. 7 non-skip ranges on every function. 4 functions: +DC Volts, -DC Volts, AC Volts, Ohms. Uniform 3 to 1 scale ratio for extreme wide-range accuracy. Zero center. One zero-adj. for all functions & ranges. 1% precision ceramic multiplier resistors. Measure directly peak-to-peak voltage of complex & sine waves: 0.4, 14, 42, 140, 420, 1400, 4200. DC/RMS rms volts: 0-1.5, 5, 15, 50, 150, 500, 1500 (up to 30,000 v. with HVP probe & 250 mc with PRF probe). Ohms: 0.2 ohms to 1000 meg. 12AU7, 6AL5, selenium rectifier; xmfr-operated. Deep-etched satin aluminum panel, rugged grey wrinkle steel cabinet.



5" PUSH-PULL
OSCILLOSCOPE
#425

KIT \$44.95
Wired \$79.95

7" PUSH-PULL
OSCILLOSCOPE
#470

KIT \$79.95
Wired \$129.50



TUBE TESTER
#825

KIT \$34.95
Wired \$49.95

- tests 600 mil series string type tubes
- illuminated roll-chart

Pix Tube Test Adapter\$4.50

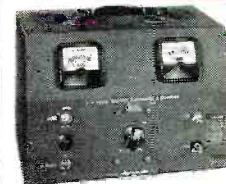

6V & 12V
Battery Elim
& Charger
#1050:

KIT \$29.95
Wired \$38.95

Extra filtered for transistor eqpt. #1060;
Kit \$38.95 Wired \$47.95



Sep. hi-gain RF & lo-gain audio inputs. Special noise locator. Calibrated wattmeter.

KIT \$24.95
Wired \$39.95

DELUXE MULTI-SIGNAL TRACER #147



20,000 Ohms/Volt
MULTIMETER #565

KIT 24.95
Wired \$29.95



1000 Ohms/Volt
MULTIMETER
#536

KIT \$12.90
Wired \$14.90



Reads 0.5 ohms
-500 meg, 10
mfd-5000 mfd,
power factor.

KIT \$19.95

Wired \$29.95

R-C BRIDGE & R-C-L COMPARATOR
#950B



VTVM PROBES	KIT	Wired
Peak-to-Peak	\$4.95	\$6.95
RF	\$3.75	\$4.95
High Voltage Probe-1	\$6.95	\$8.95
High Voltage Probe-2	\$3.75	\$4.95
SCOPE PROBES		
Demodulator	\$3.75	\$5.75
Direct	\$2.75	\$3.95
Low Capacity	\$3.75	\$5.75

EICO, 33-00 Northern Blvd., R-5
L.I.C. 1, N.Y.

Show me **HOW TO SAVE 50%** on Test Equipment and Hi-Fi. Send me **FREE Catalog** and name of neighborhood distributor.

Name.....
Address.....
City..... Zone..... State.....

TURN PAGE
FOR MORE
EICO VALUES

TEICO®

Send for
FREE CATALOG
NOW

Prices 5% higher on West Coast.

L.I.C. 1, N.Y.

CLOSED-CIRCUIT TV

By TOM SHEA

Blonder-Tongue Laboratories, Inc.

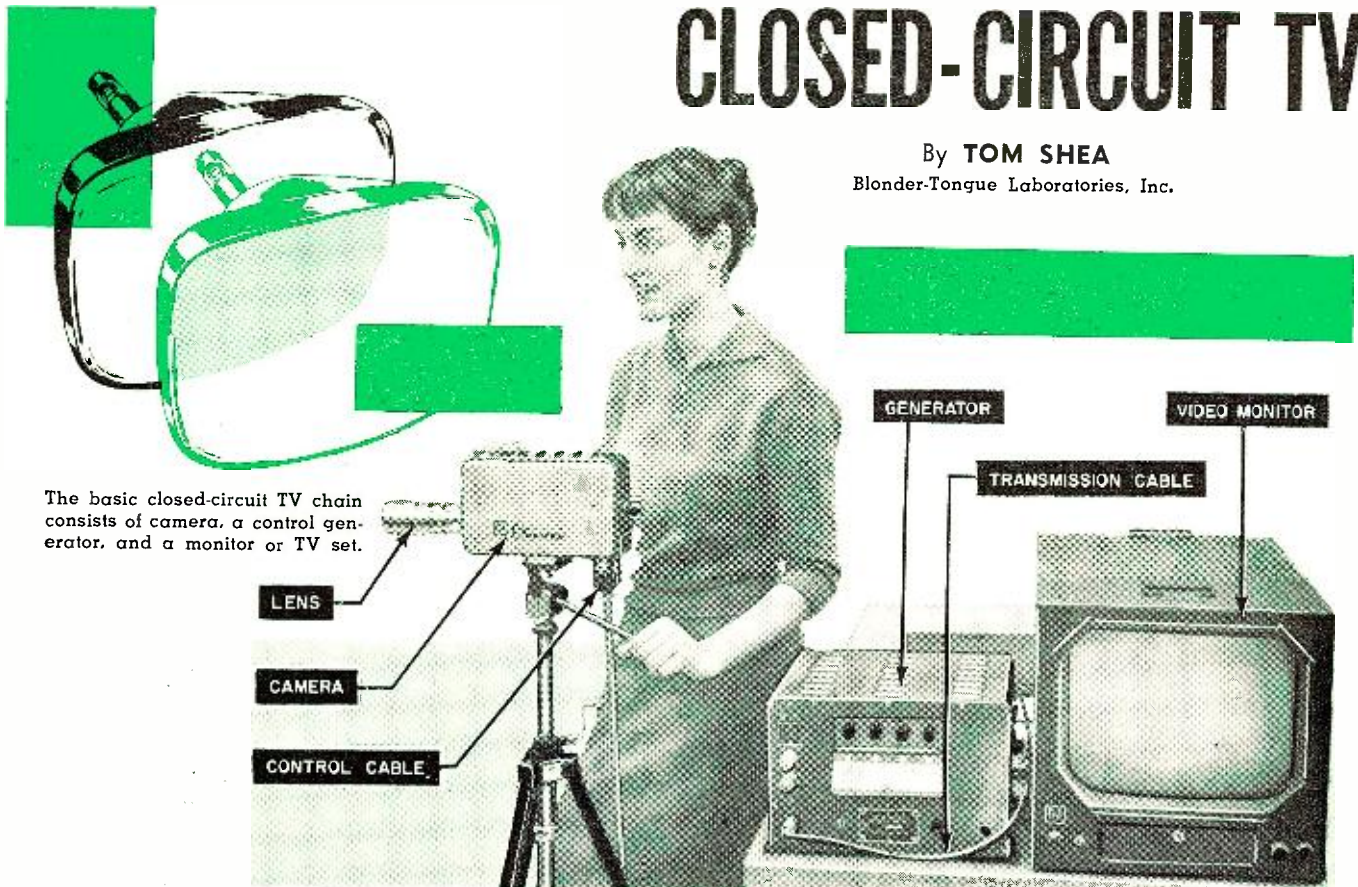

The basic closed-circuit TV chain consists of camera, a control generator, and a monitor or TV set.

TWENTY-FOUR freshly scrubbed faces were turned intently toward the large television screen on which an amoeba, magnified nearly 1000 times larger than its actual microscopic size, was slowly surrounding and deliberately engulfing another tiny organism. The teacher glanced at the class and realized she had rarely commanded such attentive quiet. A hand went up. The teacher nodded and a girl asked, "What does the amoeba do after it surrounds the food?" From a loudspeaker in the TV set promptly came the answer and two more questions followed in quick succession.

Only a few years ago, each student might have filed up to a microscope, peered in briefly, and passed on to give the next a chance for a glimpse of the microscopic drama. Today, by means of a closed-circuit television system, the science teacher can set up the experiment using one microscope and TV camera and televise it to many classes. Every student can watch the process unfolding on the TV screen and ask the questions that arise fresh at the moment of observation.

That example is but one of many applications being found for closed-circuit television (CCTV). Others are more or less dramatic or spectacular, but all prove that CCTV, although still a lusty infant as a means of communication, offers society a remarkable tool whose potential has just begun to be tapped. As a concept, closed circuit television probably dates back to the invention of television itself. As an actuality, CCTV dates from just

A new industry, still a lusty infant, offers a remarkable tool that's just beginning to be used.

after World War II. But the first few demonstrations drew little attention beyond a flurry of publicity and CCTV made little immediate headway, although several electronics firms grasped its possibilities and went into manufacture of equipment. Still, as recently as 1950, closed-circuit television sales did not amount to more than a few thousand dollars, for business men were generally inclined to regard it as a useless toy or, much worse, as a distraction which might even impede production!

Then industrial engineers, safety experts, merchandising people, traffic and materials handling engineers, along with the CCTV sales engineers themselves began showing executives how CCTV could save time, labor, and materials, how it could speed vital communications. Educators soon realized that one teacher before a TV camera could teach as many classes as had TV sets wired to that camera. Rather than being restricted to one limited size class by the age-old traditional method, one teacher could instruct an entire school, or even several schools.

As a result, sharply rising demand produced a growth of the CCTV equipment industry from 3 manufacturers in 1952 to at least 13 in 1957 making complete systems. They include *Blonder-Tongue, Duge, Diamond Power, A.*

B. Du Mont, Insul-8-Corp., International Tel. & Tel., General Electric, General Precision, Hallamore Electronics, Kin-Tel (formerly Kay Lab), Philco, RCA, and Sarkes Tarzian. See Table 1. (Editor's Note: By the end of last year industry sales were variously estimated between \$5-million and \$9-million.)

Elements of a CCTV System

A CCTV installation is a complete television transmitting and receiving system with signals transmitted through cables rather than over the air.

A basic chain (above) consists of a television camera, a control unit which may be integral with camera or separate, and a video monitor or conventional TV set. Transmission line, such as ordinary RG-11/U or RG-59/U coaxial cable, connects the transmission equipment with the video monitor or conventional TV receiver. Many numbers of such basic chains are now in use. Larger, more elaborate systems—where several cameras may supply many receivers, for example—require additional amplifying and distribution equipment. But, in practical terms, there is almost no limit to the number of receivers that can be supplied from one or more cameras.

One of the most promising CCTV system arrangements is the two-way

TV cameras may be equipped with a remote control Zoom lens, such as this Perkin-Elmer unit, which may focus on nearby performer or give "close-up" long shots.



Shown above is a photograph of a typical vidicon studio installation employing Sarkes Tarzian equipment. The cameraman at the left is operating a dolly-mounted vidicon camera which is focused on the illustration being held by the girl shown at the right.



The Diamond Power installation shown above allows the machine operator to check the position of his traveling-housing milling and boring machine by closed-circuit TV.

installation, in which cameras and TV receivers are set up at both ends of the chain. An outstanding example of two-way CCTV is found in educational applications, in which simultaneous two-way sight and sound permits students to ask questions of the instructor who is presenting the course from another classroom or from another school.

In another interesting system now working at the Los Angeles Water and Power Supply Steam Plant, ten cameras are used to coordinate control of furnace flames and steam pressure. Cameras installed at specially designed ports in the furnace walls equipped with constant cooling means, observe flame character. Other cameras are trained on boiler pressure gauges. Extremely detailed images of flames and gauges are required.

Video monitors are installed in the steam plant's main operations control board where one operator can watch several flames and make adjustments to maintain proper combustion. The system saves fuel: previously the inability of the operators to observe flames directly often produced incomplete burning and appreciable fuel

waste. The system also prevents excessive escape of smoke, an important aspect of smog prevention in Los Angeles.

St. Mary's Hospital in San Francisco is now using a very versatile closed circuit system. Permanent transmission line outlets are located in the chapel and also four floors down in the

auditorium, which is used for social functions. Camera pick-ups from other areas of the hospital are cabled to either of these outlets.

CCTV output on channel 2 is fed to the hospital's master antenna system, which also receives commercial over-the-air programs on other channels. Output from the "head-end" of

TABLE 1 CLOSED-CIRCUIT TV EQUIPMENT MANUFACTURERS

COMPLETE SYSTEMS AND EQUIPMENT

Blonder-Tongue Labs., Inc.
9 Alling Street
Newark 2, New Jersey

Dage Television Division
Thompson Products, Inc.
West 10th Street
Michigan City, Indiana

Diamond Power Specialty Corp.
Electronics Department
Lancaster, Ohio

Allen B. Du Mont Laboratories, Inc.
760 Bloomfield Avenue
Clifton, New Jersey

General Electric Company
Technical Products Department
Electronics Park
Syracuse, New York

General Precision Laboratory, Inc.
63 Bedford Road
Pleasantville, New York

Sarkes Tarzian Inc., 415 N. College Avenue, Bloomington, Indiana

Hallamore Electronics Co. Div.
The Siegler Corp.
8352 Brookhurst Ave.
Anaheim, California

Insul-8-Corporation
1369 Industrial Road
San Carlos, California

International Telephone & Telegraph Co.
Industrial Products Division
15191 Bledsoe Street
San Fernando, California

Kin Tel
P.O. Box 623
5725 Kearny Villa Road
San Diego, California

Philco Corporation
Government & Industrial Division
4700 Wissachickon Ave.
Philadelphia 44, Pa.

Radio Corporation of America
Engineering Products Division
Camden, New Jersey

COMPONENTS AND ACCESSORIES

Ampli-Vision Division
International Telemeter Corp.
200 Stoner Avenue
Los Angeles 25, California

B & K Manufacturing Co.
3726 N. Southport Ave.
Chicago 13, Illinois

Conrac, Inc.
Glendora, California

Entron, Inc.
4902 Lawrence St.
Bladensburg, Maryland

Foto-Video Laboratories, Inc.
36 Commerce Road
Cedar Grove, New Jersey

Hoffman Electronics Corp.
3761 S. Hill Street
Los Angeles 7, California

Telechrome Mfg. Corp.
28 Ranick Drive
Amityville, New York

Jerrold Electronics Corp.
23rd & Chestnut Streets
Philadelphia 3, Pa.

Miratel Inc.
1080 Dionne St.
St. Paul, Minn.

Perkin-Elmer Corp.
Main Avenue
Norwalk, Conn.

Polarad Electronics Corp.
43-20 34th St.
Long Island City 1, N. Y.

Setchell-Carlson, Inc.
330 Fifth Avenue
New Brighton, Minn.

Tarc Electronics, Inc.
48 Urban Avenue
Westbury, New York

Transvision Inc.
460 North Avenue
New Rochelle, New York

Zoomar, Inc.
Glen Cove, Long Island, New York

the antenna system is distributed to 170 TV sets throughout the hospital, with broadband amplifiers placed strategically to maintain signal strength at each television receiver's antenna terminals.

The St. Mary's Hospital system was installed originally to improve bed-ridden patients' morale by enabling them to view hospital chapel services on TV. But each month finds new uses for the system—televising an operation to more doctors than could group around the operating table; unusual opportunities in psychiatric work where behavior of disturbed patients can be observed at a distance by the doctor; training of hospital personnel; allowing bed-ridden patients to "visit" with underage relatives not permitted to go to patients' rooms. The hospital's CCTV system has proven so valuable that plans are underway to install 70 more sets in a new wing now under construction.

Other Case Histories

The uses which CCTV is already serving could fill—and already have filled—entire books. They range from simple chains, such as where a camera is installed to survey a machine operation in a factory and wired to a monitor at an observer's position; to multi-camera installations with complex switching facilities; to the tremendous commercial cable networks used to transmit a televised championship prizefight to participating theaters. Also in the nuclear energy and military missile fields, the use of CCTV is very widespread. New uses are discovered every week. Here are a few more specific applications.

Last spring Bankers Trust Company in New York took stockholders on a 25-minute "seated tour" of the bank via a CCTV installation setup. More than 300 viewed the tour on an 8 x 10 foot projection-type television screen. The noted sports announcer Red Barber MC'ed the tour, discussing banking operations with department heads on four floors and providing the stockholders with a real inside view of the bank's business plant. The success of the demonstration prompted Bankers Trust to install coaxial cable on a permanent basis. Future use of CCTV is planned to link the personal loan department with the records department in order to transmit immediate visual data on customers' past records.

A large and very elaborate CCTV system for data transmission is now in operation at Pennsylvania Station in New York City. Ticket sales and reservations to points all over the country are expedited through the use of 100 TV cameras trained on the station's reservation board. The CCTV system has cut ticket sales time from 8 minutes average per passenger down to a mere 2 minutes.

Security and crime detection are also fields in which CCTV has proved its worth. In industrial plants (and especially in national defense plants) CCTV enables a guard to survey an



COVER STORY

Use of telephoto lens on TV camera permits image enlargement 18 times normal size.

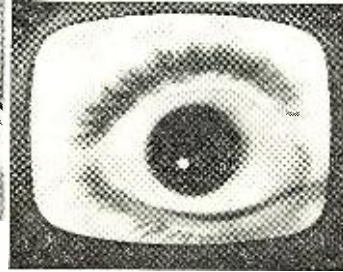

AN EYE FOR AN EYE

Closed-circuit TV has given the medical profession a new diagnostic and teaching tool of great value.

THIS month's cover photograph was made during an actual eye operation performed at Hempstead General Hospital, Hempstead, Long Island, New York. This modern hospital—it is only two years old—offers the most completely equipped and staffed facilities for eye treatment and surgery on Long Island.

Very often these days the operating room staff at the hospital is augmented by one new member—the TV cameraman. Many eye operations at Hempstead General are transmitted via closed-circuit television to an adjoining room where physicians and other staff personnel can watch every phase of the operation as easily and close-up as if they were standing over the operating table!

Equipped with a 3-inch telephoto lens, the Blonder-Tongue "Observer TVC-1A" closed-circuit television camera reproduces an image of the eye under surgery on the screen of the video monitor which is 18 times larger than life-size. Every muscle and blood vessel in the eye appears sharp and with excellent contrast as surgery proceeds. Physicians queried about their attitude toward televising surgery said that they would rather watch techniques on a TV screen than sit in an amphitheater.

Medical applications of closed-circuit TV are numerous. Both hospitals and pharmaceutical companies are turning more and more to this new visual medium of communication for instruction, for opera-

tional use in x-ray and other radiation treatment, and for medical advertising and promotion. At the University of Kansas Medical Center, the use of closed-circuit TV began seven years ago with the transmission of daily programs of instruction from the operating room of the hospital; expanded to a multitude of uses with color TV pickups made in laboratories, delivery rooms, and other areas in the Center; and now includes classroom use to present each student with a close-up vantage point in any demonstration.

At the Nebraska Psychiatric Institute in Omaha, a closed-circuit TV system is now being used to observe patients under psychiatric care from a remote spot; a projection system in the Institute's auditorium permits several hundred students to view the patient simultaneously during lecture-demonstration sessions.

Color television is especially valuable in medical applications. The General Electric Company now has a color TV chain designed for closed-circuit applications and institutions that can afford its \$25,000 cost have found it invaluable in instruction and diagnostic work.

Monochrome closed-circuit television has been reduced in cost to the point where it is well within the budgets of today's hard pressed hospitals. Many are adopting such black-and-white gear as an essential tool of modern hospital operation and medical education. (Cover by Elkin Photography)

Technicians can now administer radiation to patients without danger to themselves. A closed-circuit TV monitor keeps track of treatment in a radiation-shielded control room. This photograph was taken at the Albert Einstein Memorial Hospital.

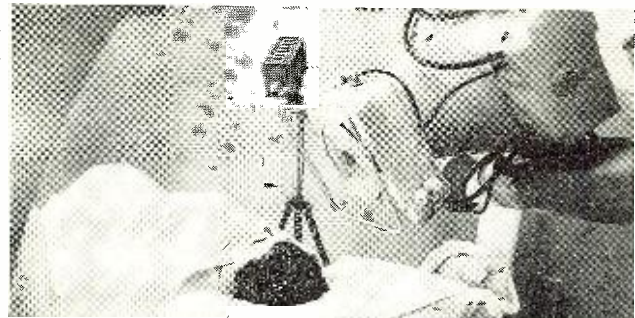

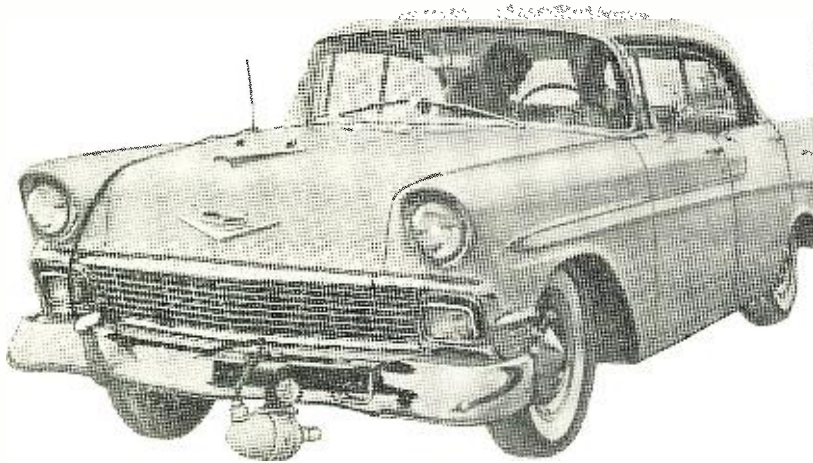

↑ Bolted to the underside of a test car's front bumper is a closed-circuit TV camera made by General Precision. Suspension system action may be seen on monitor in back seat of the car.

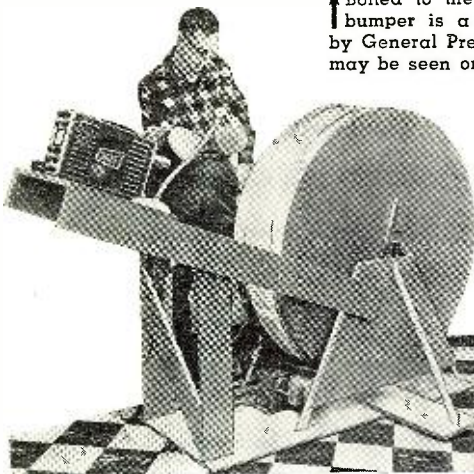

TV cameras enable men at the control pulpit to watch movements of large steel slab, and help line up the slab for the maximum shearing accuracy. The closed-circuit TV equipment that is employed here is Radio Corp. of America gear. Industrial type applications such as this make up a rather large amount of present-day CCTV business.

← In the news room of the "Berkshire Eagle," Berkshire, Massachusetts, news bulletins are placed on the huge revolving drum and are transmitted to the street by the Dage television camera shown to the left. Pedestrians on the street may then read the news stories as they are transmitted by the CCTV system.

entire floor, or several entry gates, or a hazardous or restricted area. Cameras spotted around a warehouse discourage pilfering. At the Bambergers Department Store in Newark, N. J., a CCTV system using three cameras trained on small articles counters has cut down shoplifting, not only because of the actual surveillance it makes possible, but because news of the installation has been widely spread to the public. No self-respecting shoplifter feels safe anymore in Bambergers knowing that a lens may be trained on his face anywhere in the store!

CCTV systems have proved invaluable in preventing uncontrolled exposure to radioactivity. The Alfred Einstein Memorial Hospital in Philadelphia uses a CCTV chain which en-

ables an X-ray technician in another room to view a patient who is undergoing radioactive cobalt treatment without danger of overexposure to himself. At several atomic reactor installations CCTV permits surveillance of the reactor from a safe, remote observation position.

CCTV is in very wide industrial use. At the Southwestern Portland Cement Company in Fairborn, Ohio, a CCTV camera perched at the lip of a slurry (mixing) kiln eliminates the hazardous climb up a long ladder formerly required to check slurry flow and spot any signs of congestion. At the Ketchikan Pulp Mill in Alaska, one of the most modern in the world, a CCTV camera is trained on the main 400-ton surge bins to guard against costly overflows—a job formerly done by a

man who was in a dangerous position.

At *Blonder-Tongue Laboratories*, equipment response curves displayed on an oscilloscope at the final production test position are picked up by camera and transmitted to a video monitor placed before the quality control technician seated 120 feet away. By glancing at the screen he can quickly check response quality and maintain production quality.

Education is perhaps the most challenging—and the most controversial—field for CCTV. Educators and congressmen have hailed CCTV as a revolutionary tool that can bring education into step with the nuclear age. Others have condemned it as the first step in the "dehumanization" of the educational process. The controversy rages, but notable experiments with CCTV are already in process.

In Hagerstown, Maryland, a five-year pilot project linking 23 schools in a CCTV system went into operation in September 1956. Now a highly competent science teacher performs basic science experiments before a camera while 554 children throughout the system watch their classroom screens with, it is hoped, rapt attention. Simultaneously, a skilled mathematics specialist explains the intricacies of elementary arithmetic to over 500 second-graders *via* the CCTV network. Altogether, instructional programs originate at four different locations simultaneously. The project is sponsored by the Fund for the Advancement of Education, and the Electronic Industries Association (formerly RETMA), with equipment donated by CCTV manufacturers.

The Hagerstown experiment is one of many: in a Phoenix, Arizona high school, biology experiments are transmitted by CCTV to other school rooms; non-English speaking residents of the Chelsea district of New York City are learning English *via* CCTV; at the Dental School of the University of Texas, students watch dental surgery close-up *via* CCTV and ask questions of the instructor at any time by means of a two-way audio

(Continued on page 144)



World's first closed-circuit 3-D color TV system was developed by General Electric for AEC. Polarizing glasses, shown here atop special dual-lens color camera, must be worn by the viewer to get the 3-D effect. The new system will provide closeup vision for workers who are remotely servicing nuclear reactors.

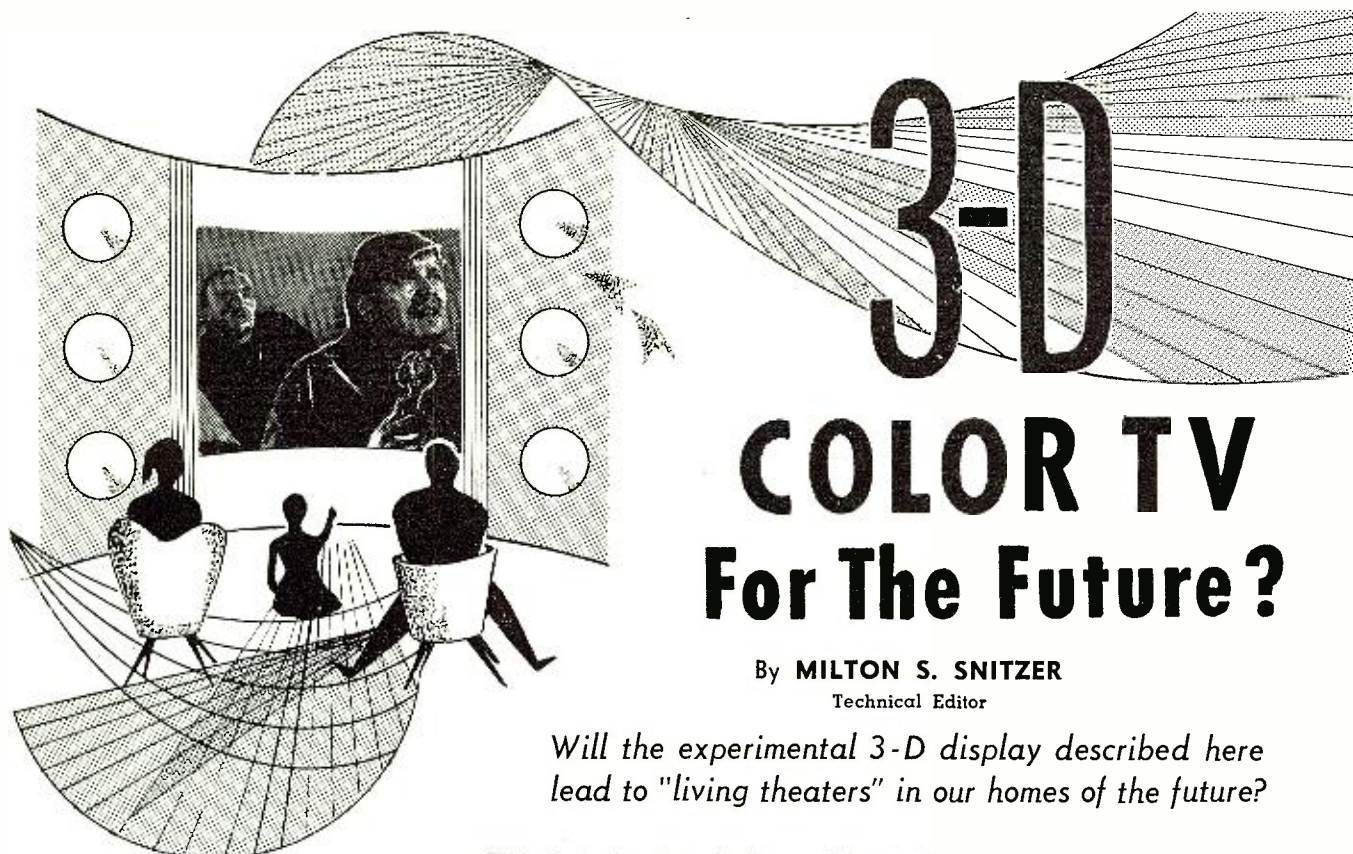

3-D COLOR TV For The Future?

By **MILTON S. SNITZER**
Technical Editor

Will the experimental 3-D display described here lead to "living theaters" in our homes of the future?

WHAT will our TV sets of the future be like? Surely we should not have to keep our eyes glued to a rather small flat screen with tiny flat figures on it. Just imagine what depth and realism could come from a large three-dimensional colored image—just like a real-life play right in our own living rooms. This would not be an optical illusion but real 3-D.

Some 3-D Methods

The movie industry has experimented with two methods that can give the illusion of depth. In one, two differently colored images are superimposed on the flat screen. If the viewer then sees these through special glasses whose lenses match the colors of the images, he will see one image with one eye and another image with the other eye. The two separate pictures are combined in the mind of the viewer to produce a 3-D picture.

Another idea is to project one image with light that is polarized in one direction, and project the other image with light polarized in another direction. Again, special glasses made up of polarized light filters could be used to produce the two separate pictures needed for 3-D. With this second method, full-color pictures can be given depth and realism.

Recently, *General Electric* has developed the world's first 3-D color television system for remote servicing of nuclear reactors. This system is strictly a closed-circuit setup that is not currently feasible for the living room. The technician who will view the picture will use special polarizing glasses like those used for 3-D movies.

But what about producing a picture that has true depth and does not require special glasses or other illusion techniques? The 3-D display device to be described may provide the answer.

3-D Electroflor

Electroflors are certain new materials that can store electrical energy. When an indicating material is added, the combination will give off light if electrically stimulated by fairly low voltages. Normally the material is crystal-clear. About 50 electroflors are available from such companies as *Shannon Luminous Materials Co.*, Hollywood, Calif. with a variety of colors and storage times.

In practice, a flat glass or plastic plate with a series of tiny holes may be used. A gridwork of fine wires criss-cross each hole, which is filled with the electroflor and sealed. The

leads can also be evaporated metal coatings, thin enough to remain transparent. With 500 leads on a side and a 25-inch square, definition about equal to a conventional TV picture tube may be had. The plates may be made as large as needed.

By the use of 3 thin plates sandwiched together, each of which glows with a primary color, it is possible to produce a full-color display. Then by stacking a number of such plates together to any desired thickness a true 3-D display is produced. Experimental versions of such displays have already been made. Of course special scanning signals would have to be used to produce a TV-like raster.

Perhaps after we have added color and depth to our TV of the future, we may want to make the display even more real by adding odors. Can't you smell that sizzling steak now? —[50]

Experimental unit made up of two sets of wire electrodes at right angles to each other supported and insulated on a glass plate. Tiny holes at the intersections of the wires are filled with a transparent electroflor and the assembly is sealed. The electroflor will fluoresce and give off light of various colors when electrically stimulated. Any number of these flat plates may be stacked together to produce a true 3-D display device.

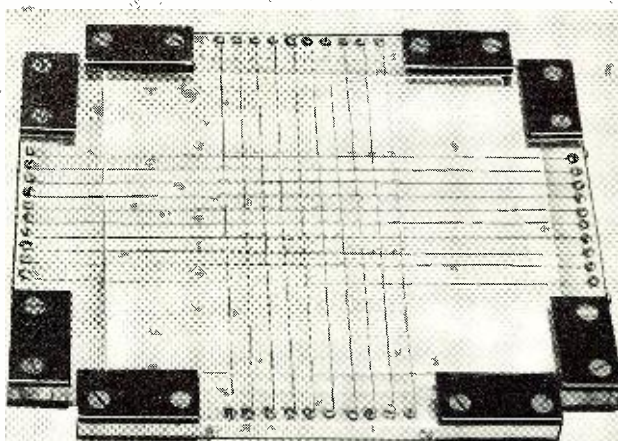

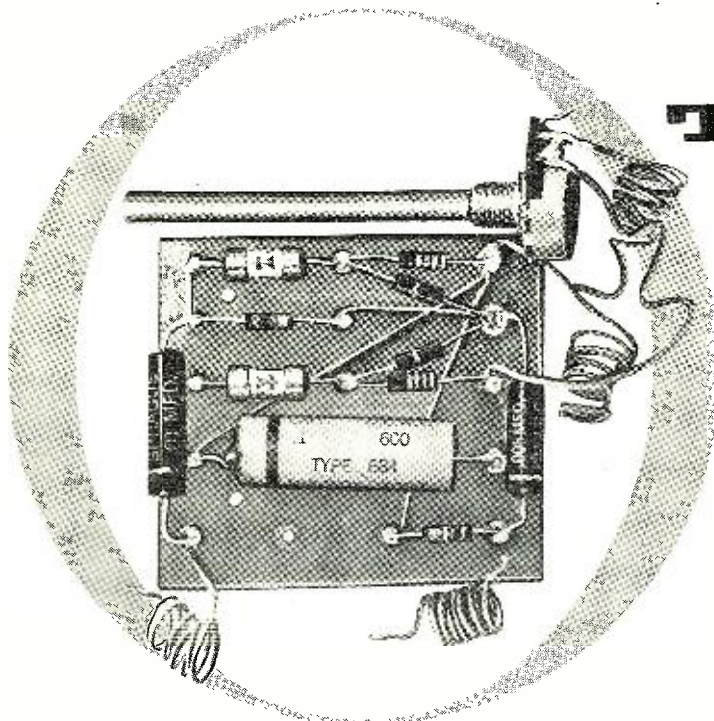

The Zero Clipper?

By HECTOR E. FRENCH, W1JKZ

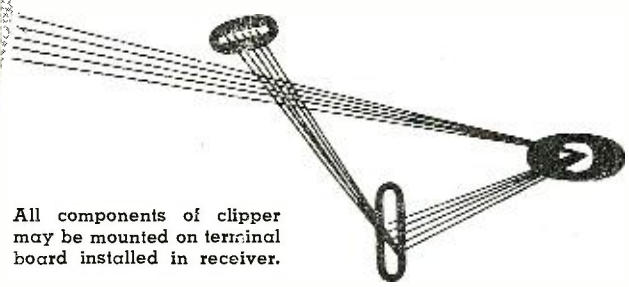

All components of clipper may be mounted on terminal board installed in receiver.

Simple dual crystal noise clipper may be added to receiver for improved ham phone or s.w. listening.

BACKGROUND noise is always a problem in short-wave communication. It always seems that the station you want to hear is just loud enough to be tantalizing. A word or two comes through now and then, but not enough of them to be useful. And even when the words are all understandable, the background noise is often loud enough to be objectionable on a rather large percentage of the stations.

This problem differs at the different frequencies. At the lower communication frequencies, which are usually more crowded, the problem is more apt to be interference from other stations. It's at the higher frequencies that the background noise really gets enthusiastic. You'll find spots on the dial where the galaxy itself—our own Milky Way—adds its own contribution of background noise in your receiver, just to make your job of picking out weak signals a little bit harder.

In fact, a certain amount of background noise seems to be built right into the universe. Physicists tell us that every body hotter than absolute zero will radiate energy. And since the cathodes of the vacuum tubes are much hotter than anything else in a receiver, you can expect the tubes to contribute to this background noise energy. Some of this background noise is even caused by individual electrons trying to make up their minds whether to stop at the screen or whether to keep on going all the way to the plate!

There are a number of ways to improve the signal-to-noise ratio for

small signals, at your receiver. One way is to use a conventional tone control. Much of the noise usually appears to be in the 1000 to 3000 cycle range of frequencies, where the human ear is the most sensitive. Unfortunately, this is also the range of frequencies that carry most of the information in a speech signal. By the time the tone control has been turned up far enough to cut off some of the background noise, it has also cut off some of the signal. Instead of a tone control, then, you might use a sharp filter, to cut off any noise components outside of this speech range of frequencies.

Another trick which helps cut down the apparent background noise uses an audio system which is as free as possible from resonant peaks. With such peaks, some sharp noise pulse, as from automobile ignition or a syllable of speech, will throw some part of the system into a train of damped oscillations and make the noise sound louder than it really is.

Another common way to improve the signal-to-noise ratio is to use a peak clipper circuit. This circuit is based on a rectifier which lets ordinary audio signals through without affecting them but which clips off any sharp pulse-type interference (as from automobile ignition) that is higher than the signal. This keeps the audio system from being shocked into a damped oscillation with every sharp pulse of interference. However, this kind of circuit doesn't help cut down background noise, because the noise peaks don't stick up far enough above the signal so the rectifier cir-

cuit can have something to work on.

In order to cut down on the background noise, let's first look into the characteristics of a speech signal, in comparison with the background noise. If this were done on an oscilloscope, there is one important difference that would become apparent right away: the speech signal looks like a series of pulses of audio energy, while the background noise is continuous. Communication by speech is apparently carried out by these bursts of audio energy, with each burst being a syllable. These syllables are shown, along with background noise, in the first waveform of Fig. 4.

This difference—between the "pulse-modulation" communication of speech and the steady interference of the background noise—is the clue toward a method of improving the apparent signal-to-noise ratio. If the actual communication is carried out by the pulses, it should be possible to design a circuit to let the pulses through and hold back the steady background noise. This should not only improve the signal-to-noise ratio but should also trick the ear into thinking there's even less noise left than there really is, since the ear won't have to strain so hard to try hearing every word as it comes popping up out of the noise.

Fig. 1 shows the first circuit designed to check out this method of improving the apparent signal-to-noise ratio. This circuit uses a pair of shunt diodes, which act like a pair of normally closed switches. Each diode "switch" across the audio circuit stays closed until the signal is higher than a certain "trigger" value, which is determined by the setting of the 2-megohm control. As soon as the signal is above this "trigger" value, the diode switch opens (because each diode plate is then negative with re-

spect to its cathode) and allows the signal to pass through. In this way, each time a syllable comes along as a burst, or pulse, of audio energy, the diode switch opens and allows the signal to pass through. As soon as the syllable is through, the diode switch closes and shorts out the background noise. This circuit would be called a "zero clipper," because it eliminates everything from zero volts up to a certain "trigger" value, while the peak clipper eliminates everything from a peak value down to a similar "trigger" value.

In operation, this circuit was a definite help in improving the apparent signal-to-noise ratio, especially when the background noise seemed to be just about as loud as the signal. Listening tests, both with experienced phone operators and with people who had never heard short-wave signals, showed that the zero clipper would make the difference between getting the information and not getting it.

However, this circuit does have definite disadvantages. It requires a vacuum-tube dual-diode (a 6AL5 was used here), a heater supply, a tube socket, and space on the chassis to mount the tube. In addition, this circuit required a change in the output stage cathode circuit, to take care of the d.c. component at the output of the clipper circuit.

Most of these problems are overcome in the series circuit of Fig. 2, which uses a pair of 1N34 semiconductor diodes in place of a pair of thermionic vacuum-tube diodes. This eliminates the tube and tube socket, uses fewer parts, takes up less space, requires no heater current, radiates no heat, and is easier to install in existing equipment. Just as was the case in the preceding circuit, the rectifiers here act as switches. However, with this circuit, the switches are in series with the audio line, rather than across the audio line. Because of this, the diode "switches" must remain open for all voltages between zero and the "trigger" value and close for voltages above this value. With the switches open, the circuit reduces to a straightforward resistance attenuator circuit, which lets only a small percentage of the signal through. The attenuation of between-syllable noise is theoretically around 20 db.

With this circuit, when a syllable sends the input voltage to the zero clipper higher than the "trigger" value, which is set by the 2-megohm control, the diode switch closes and the signal passes through. After the syllable is finished, the between-syllable noise is not high enough to pass through the diodes and, instead, must pass through the resistances. Or, expressed in another way, the background noise has to go through a 1-megohm resistor, while the signals go around the resistor.

This circuit works even better than the shunt-diode circuit. One very important improvement, in addition to the ones outlined a few paragraphs

ago, is that this circuit causes much less signal loss than the earlier shunt circuit using vacuum tubes. Also, with this circuit using semiconductors, the transition from "switch open" to "switch closed" is not as abrupt as with a thermionic diode, which results in less audio distortion. This is given in Fig. 3, which shows a sine-wave signal and its appearance after passing through the zero clipper circuit. If the diodes were theoretically perfect switches, the output from a sine-wave input would be an approximate sine wave having a sharp irregularity near the zero voltage axis. However, since the diodes in this circuit are not perfect diodes, the distortion is not as bad as the figure would show. Instead, the zero clipper output will have a moderate amount of third and fifth harmonic distortion caused by the square-law rectification of these diodes at small signal levels.

Fig. 4 shows what happens to a phone signal which is unfortunate enough to sound at about the same level as the background noise. The first example, Fig. 4A, shows how the syllables are actually higher than the noise, but that the noise sounds just as loud as the signal because the noise is present all the time, while the signal is intermittent. The psychological effect is to make the noise sound louder than it really is. The second example, in Fig. 4B, shows the "trigger" level at which the zero clipper is to operate; signals between this level and zero are to be wiped out, while the voltages more positive or more negative than the trigger levels are to pass through. Fig. 4C shows what the signal looks like after the zero clipper has operated on the signal. Here, each syllable comes through with its own share of noise plus added distortion—but the noise between syllables is wiped out.

The photograph shows one of the series-type zero clipper circuits, built on a punched board taken from a piece of experimental commercial
(Continued on page 118)

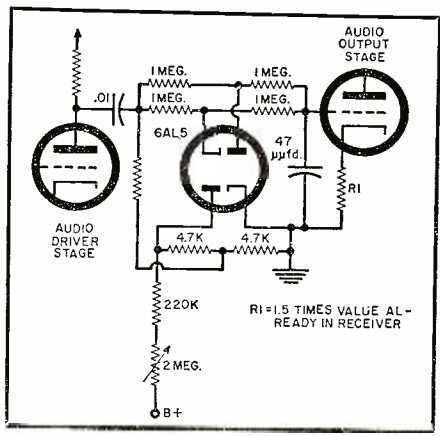

Fig. 1. Shunt type zero clipper requires vacuum tube and changes in output circuit.

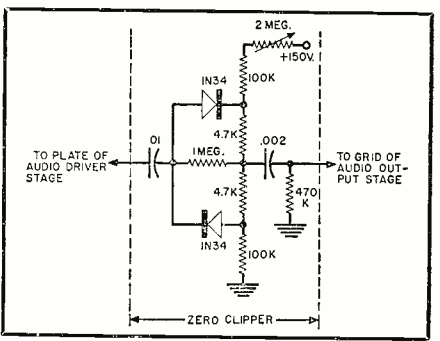

Fig. 2. Series type zero clipper using crystal diodes. No circuit changes needed.

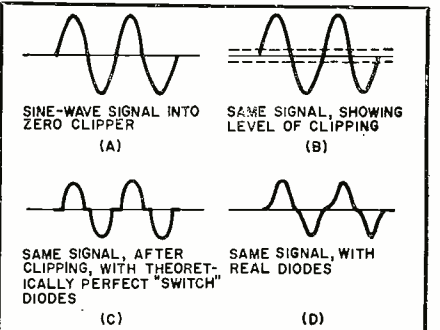

Fig. 3. Operation of zero clipper on a sine-wave signal is shown in this figure.

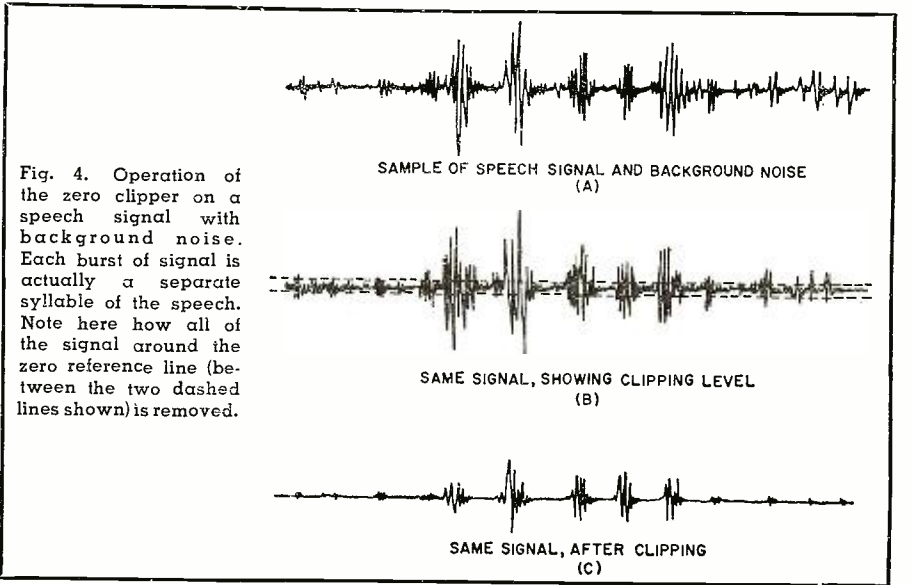

Fig. 4. Operation of the zero clipper on a speech signal with background noise. Each burst of signal is actually a separate syllable of the speech. Note here how all of the signal around the zero reference line (between the two dashed lines shown) is removed.

The Cable Tracer-Checker

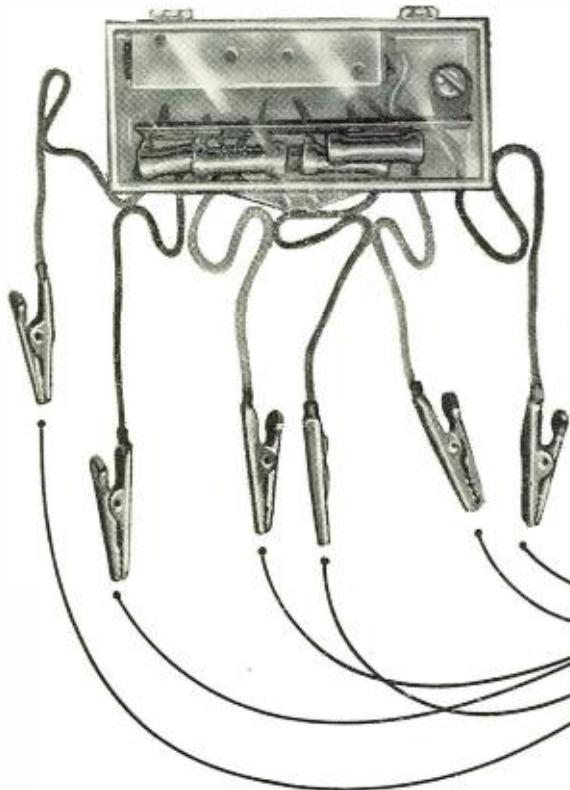

Fig. 1. A completed version—the author's—is built into a plastic case small enough to be held in the hand.

By
FORREST H. FRANTZ, Sr.

Does lead identification in multi-conductor cables annoy you? Try this sure-fire, rapid technique.

WHEREVER the electronic technician encounters multi-conductor cables, whether it be in industrial work, intercommunication-system service, or any other branch of the field, he is likely to run into an exasperating situation. The problem arises whenever the conductors in a cable are not color coded or when someone has switched the colored leads at a splice. The trouble is more likely to be met in older installations or amateur installations. The question: how to identify the uncoded or mis-coded conductors? This problem is also occasionally encountered within the chassis of a single piece of electronic gear or in inter-chassis cabling.

One way to solve the problem is to connect all but one of the conductors

together at one end of the cable (end A) and look at the other end (B) for the conductor that is free with an ohmmeter, as shown in Fig. 2A. When this conductor is located and tagged, a second conductor may be disconnected from the common connection, as shown in Fig. 2B. This conductor may then be located and tagged and the process may be repeated until all of the conductors have been identified.

This procedure is tedious. If the distance between the ends of the cable is great, the job can consume a good bit of time and energy. There are ways in which this basic procedure may be simplified, but they're hardly worth exploiting. Why? Because an extremely inexpensive and simple accessory can be built to make cable tracing a snap. This accessory reduces cable tracing to a pat procedure and makes it possible to identify conductors in a matter of minutes. Furthermore, this accessory may be used to find shorts and opens in a multi-conductor cable rapidly.

The accessory is the "Cable Tracer-Checker," shown in Fig. 1. It consists of a penlite battery voltage source and a voltage divider made up of five 100-ohm resistors. The tracer-checker is used with a voltmeter. The type of voltmeter you use will generally determine the battery voltage. The accessory described is good for checking six lines at a time, but, by increasing the number of resistors, you can increase the line handling capacity. The schematic is shown in Fig. 3A.

To use the unit, connect it to the

remote end of the cable as shown in Fig. 3B. Assume conductor number 0 to be an additional wire external to the cable for the moment. Connect the negative terminal of the voltmeter to it. The battery voltage E should be equal to the voltage of a convenient scale on your voltmeter.

The author's meter has a 1.5-volt range, so he used a 1.5-volt battery. This meter, it so happens, also has a 5-volt range. Thus, when the positive meter lead is connected to conductor number 1, the meter conveniently reads "1" on the 5-volt meter scale. This conductor is then tagged. When the unknown conductor which the positive meter lead touches is number 3, the meter will read 3 on the 5-volt scale. When number 4 is touched, the meter reads 4. Thus, any cable with six or fewer wires can be checked and identified quickly. While not all me-

(Continued on page 137)

Fig. 2. Steps in the basic method for identifying conductors in a cable.

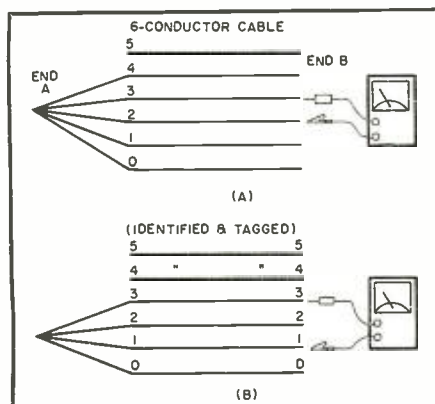
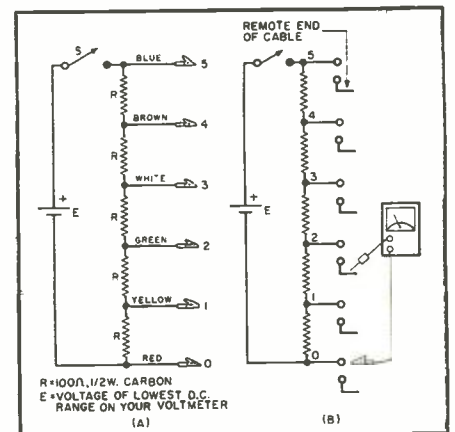

Fig. 3. Schematic (A) for the cable tracer-checker. In practice, it is used in conjunction with a voltmeter (B).



Microphones for Tape Recorders

By **NORMAN H. CROWHURST**

Tina Robin, recording star →
for Coral Records, makes a
tape on the Tandberg recorder.



A HOME tape recorder is probably one of the most versatile possessions one can have, both in providing entertainment or in doing many useful jobs. You may have bought it in the first place for the purpose of recording your own voice and that of your friends but it has many other uses. For example, this article is being dictated into a home recorder. The author also uses the same recorder quite frequently for "writing" letters to friends in different parts of the world.

Real fun can be had with a tape recorder at a party, either playing deliberate games built around the tape recorder or just leaving the recorder on to pick up random conversation. If you have some friends or members of the family who are musical, making recordings of their efforts can be an extremely interesting hobby. Recording junior's school graduation or, when friends or relatives get married, making a recording of the wedding ceremony as a present to the newlyweds will be much appreciated, both now and in the years to come.

The recording of local concerts, musical groups, or other functions, is something that will always be appreciated in the community. If you are a home movie fan, another thing you can do with your tape recorder is to make a recorded commentary as a "sound track" for your movies. This does not need accurate synchronization as a rule, if the commentary merely relates the events or background of the scenes being seen at the moment.

There are applications, such as recording programs off the air, which do

*Get more fun and greater use from your present
tape recorder by adding a better microphone.*

not require a microphone. But notice that all the uses we've just mentioned require the use of a microphone and proper technique in the use of the microphone is necessary if you are to get the maximum enjoyment from your home recorder.

All home recorders come with a small microphone, usually intended for close speaking and giving quite *recognizable* quality in the reproduction. With careful use this microphone can be made quite effective for several of the purposes just outlined. Recording people's voices, letter-writing, and many of the things you would want at a party, for example, can all make use

of the microphone that comes with the machine.

In a pinch it can probably be used for some of the other jobs too, but better results can be obtained by using a better microphone. The one that comes with the recorder is usually a low-cost unit, so the recorder can be sold at a competitive price. The recorder manufacturer does not expect only that microphone to be used. That is just "to get you started" and he knows once you have the recorder you will find it such an absorbing hobby you will

Electro-Voice Model →
667 dynamic mike.

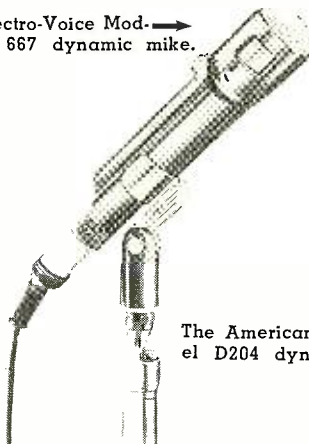

The Shure Model →
330 ribbon microphone.



The American Model →
D204 dynamic mike.

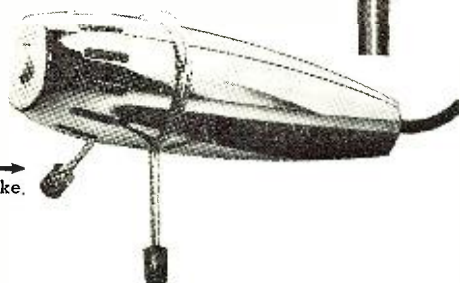

Altec Lansing Model 680A dynamic mike.



The Fen-tone "Rib-bonette" microphone.



Astatic Model M-332 crystal microphone.

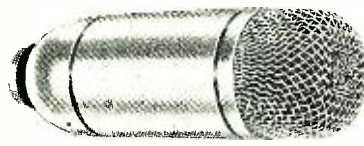
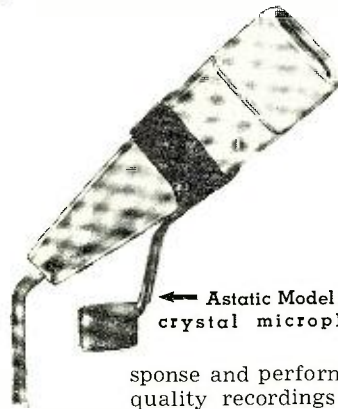

Telefunken Model ELA M410 dynamic mike.

probably go for a better microphone.

Home recorders do not come with better microphones for two reasons: (1) The extra cost would add to the price tag and make the buy uncompetitive. (2) Choice of a better microphone should be up to the user, for reasons we shall presently see. And when you buy a better microphone, the one you already have is not necessarily a dead loss. It still has its uses.

Usually the type of microphone that comes with the recorder has been chosen because of its good intelligibility. It may still be the best unit to use for letter writing, dictating, or recording people's voices close to. The better microphones are usually of more use in picking up at longer range, because it is in this sphere that the low-cost microphone does not perform so well (because of its usually irregular peaky response that causes it to be frequency selective in reverberation pickup). They may also have improved re-

sponse and performance so that better quality recordings may be made. So you want to know how to choose a satisfactory microphone for the other jobs that the original microphone does not serve so well.

Mounting the Microphone

Probably the first thing to decide is the kind of mounting your microphone should have. Most professional microphones, and many of the lower cost ones suitable for the home user, come as a separate "head" that may be attached to any kind of mounting, such as a handle to hold in the hand, a table stand, desk stand, or floor stand, according to the use desired. Other microphones come complete with their mounting, such as a desk stand, a table stand, a hand mounting, or the lavalier type microphone that can be hung around the neck and worn on the chest, or complete with a floor stand.

Some come with a complete interchangeable arrangement, adaptable to two or three of these methods. The best thing to do is to figure out how many ways you want to use the microphone based on where you plan to use it and then buy one that will serve all of these purposes reasonably well. It can be very exasperating to take the tape recorder and microphone along with you somewhere to make a recording and then find you have nowhere to put

the microphone, no convenient "sky hooks" to hang it on!

Mike Technique

The microphone that comes with the recorder usually works best when a person speaks quite closely into it, at a distance of not more than 6 inches, for example. If you put the microphone down in a room somewhere, on a table or stand, and try to pick up sounds from all over the room, you will find you need to turn the volume of the recorder all the way up. Then sounds from all over the room may be audible when you play the tape back at the same level.

There may also be considerable hum because the recorder does not work as well when all the gain is used for both record and playback. It really means, too, that you are not getting enough onto the tape, to get background noise and hum reasonably below the sounds to which you want to listen.

But there is another thing you will probably notice if you use the microphone that came with the recorder in this way. The sounds all over the room are accompanied by a lot of echo that you don't notice listening to the sound in the ordinary way. This is because the listening faculty in our brain is able, by the use of our two ears, to differentiate the sounds picked up, and "listen" specifically to sounds you want to hear while rejecting others.

This means that, in normal listening, we subconsciously reject the reverberation of the room, the echo around the walls, and act as if it were not there. We can only do this because of our two-eared listening faculty that enables the brain to differentiate between the original sound we want to hear and its echo after having traveled around the room.

No microphone can discriminate in this way. It picks up the original sound together with its echo and, when recorded together on the tape, our listening faculty has lost the capability of separating. This is because, when played back, both groups of sound come out of the same loudspeaker together. The original sound no longer comes directly from the voices of the people, or the musical instruments, or whatever it may be, while the reverberation comes from different walls of the room. All of it comes from the loudspeaker.

This is why we need some "microphone technique" to make the best use of the sound in recording. We need to get a realistic impression which requires that we pick up a "balanced" mixture of sound, so it plays back as near as possible a resemblance of the original sound. To do this with many microphones we either have to speak more closely to the microphone or have the microphone closer to the source of sound, the musical instrument or whatever it is.

The alternative is to use a microphone with a directional characteristic that "listens" more in the direction of the sound we want to pick up than in

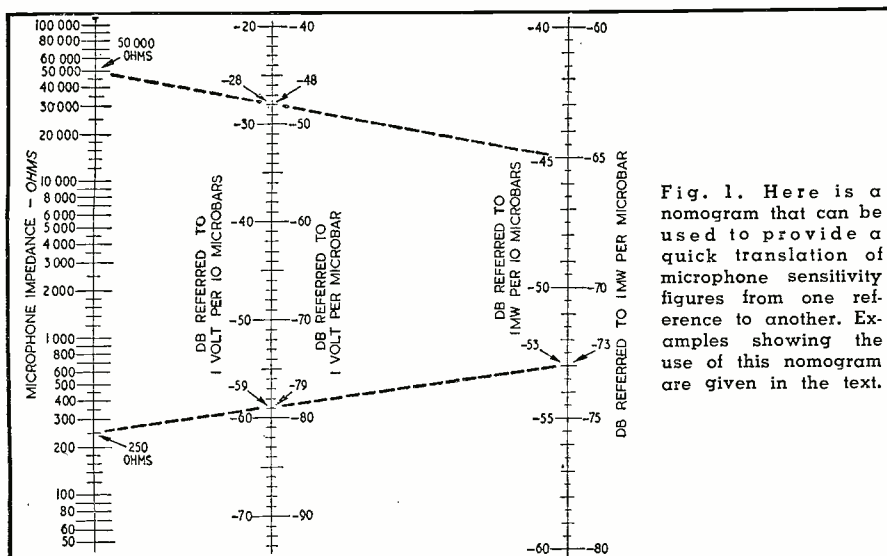

Fig. 1. Here is a nomogram that can be used to provide a quick translation of microphone sensitivity figures from one reference to another. Examples showing the use of this nomogram are given in the text.

the various directions from which the echo may come.

Frequency Response

There is another difference between the low-cost microphone that came with the recorder and the high-quality one you should use for making recordings of music, or even other kinds of sound, where the microphone is at a greater distance from the source of sound. This is in the frequency characteristic of the microphone. For the small close-talking microphones, the design is usually made somewhat "peaky" or with resonances.

Skilful design in this way can give speech a "crisp" reproduction that makes it rather pleasant to listen to and gives a satisfactory and recognizable characterization of the person's voice. When the same microphone is used at a greater distance, with more amplification, the resonance of the microphone interacts with the echo from the room to produce a most unpleasant effect. That added crispness and a pleasant tone for picking up voice close to, now produces a hollow ringing sound to the echo components that are recorded along with the sounds you really want to hear.

To avoid this, the higher quality microphones have a much smoother frequency response and avoid the peaky method of gaining sensitivity as well as providing some discrimination in what they pick up.

Sensitivity and Impedance

There are two more important characteristics you need to know in buying a microphone to use with your tape recorder. These are its sensitivity and its impedance. Microphones differ widely in the sensitivity, that is, the amount of electrical output they provide for a given sound input. A less sensitive microphone may not give sufficient electrical output to work satisfactorily with your recorder.

The other thing—*impedance*—has to be right in order to make proper use of the electrical output that the microphone gives. If your recorder is designed to work with a high-impedance microphone, which is the usual arrangement, a low-impedance microphone will be almost "dead," even though it is sensitive enough with the right recorder input connections. If your recorder comes with a low-impedance input then a low-impedance microphone would be satisfactory.

Low-impedance microphones are used for professional work because they enable longer leads to be used between the microphone and the amplifier or recorder than are possible with high-impedance microphones. But for home recording use, the distance between the microphone and the recorder can usually be kept to not more than, say, 10 or 12 feet which is satisfactory for many high-impedance microphone applications.

Let's see what difference in sensi-

The Ronette →
crystal mike.



The Electro-Sonic Type
MC 4 dynamic mike.



Turner Model 142 dynamic microphone. →

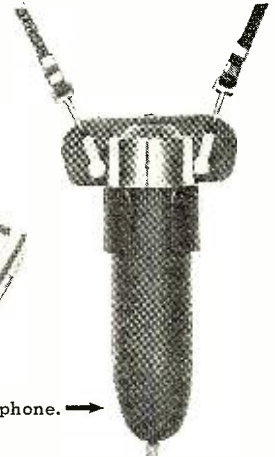

tivity can mean. The standard microphone sensitivity, used for broadcasting purposes, gives an output rated at -55 db. This can mean two things according to whether the microphone is low or high impedance. For a high-impedance microphone -55 db means the output voltage for a sound pressure of 1 microbar is -55 db (about 2 mv.) relative to 1 volt electrical output.

A sound level of 1 microbar is quite a small sound—nothing like close-talking, so some manufacturers will list instead the output level for 10 microbars. If the same microphone, rated at -55 db for 1 microbar, is rated for 10 microbars, the rating becomes -35 db.

For a low-impedance microphone, the reference, instead of being 1 volt for a microbar of sound, is 1 milliwatt for 10 microbars. This is almost universal and the level corresponding to a sensitivity of -55 db, after an appropriate input transformer has been used in the recorder, comes out pretty much the same as -55 db referred to 1 volt per microbar from the high-impedance microphone.

The important thing in comparing sensitivity is to make sure of the reference level. A specification which merely says that the microphone has a sensitivity of -43 db means nothing unless you can find somewhere what the reference level is. Even then, of

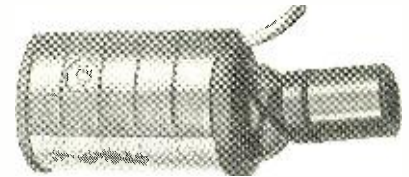

RCA Type SK-45B dynamic microphone.

course, the use of so many different reference levels can make things quite confusing. So to aid in making transfers from one method of reference to another, the chart of Fig. 1 can be a great help.

If a low-impedance microphone is rated in reference to 1 volt per microbar (as some are), its output with reference to 1 milliwatt per 10 microbars can be obtained by aligning its impedance on the left scale with the volt-per-microbar reading on the center scale and reading off the milliwatts-per-10-microbar rating on the right scale.

When looking for a new microphone you will need one at least as sensitive as the one that came with the recorder or else you will need a preamplifier to get sufficient amplification for the long distance pickup you intend to use with the better microphone. (Editor's Note: Most home recorders require micro-

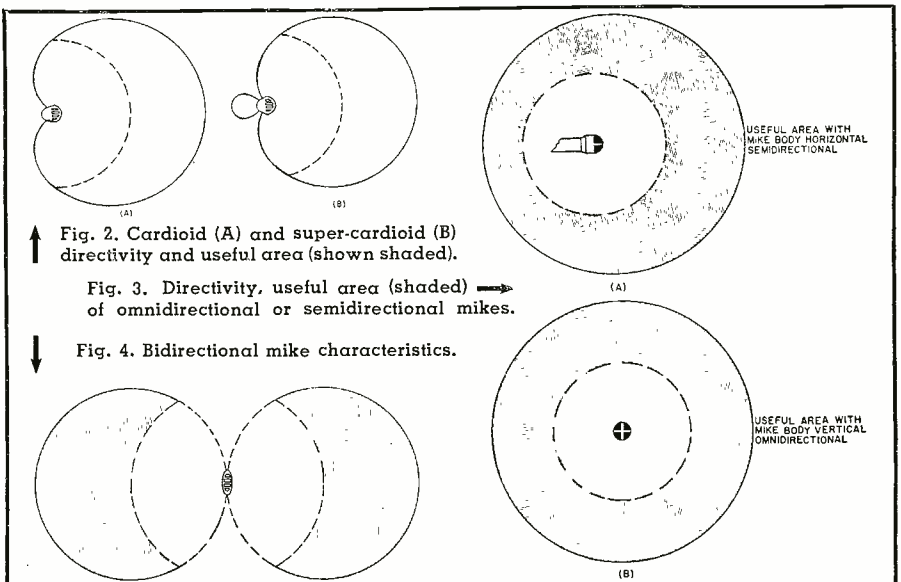

phone sensitivities of -55 db or better in order that hum does not become a problem. With professional-type recorders a less sensitive microphone, -60 db or better, may usually be used.)

The first thing to do is to find out the sensitivity of the microphone you already have. This you can do by finding out whose microphone it is and then looking it up in the maker's catalogue.

You may find the microphone has a sensitivity of about -53 db (some even have a sensitivity as high as -45 db). If you have one of these high-sensitivity microphones (usually crystal), the only way to get better performance will be to use a preamplifier with a somewhat lower-sensitivity, long-range microphone. The best suggestion here is a small microphone preamplifier, transistor operated. A few of these have already become available and it is expected in the near future that many more of this type of preamplifier will appear on the market.

The transistor type is particularly good because it can be battery-operated. The drain on the battery is very low and the battery will last a long time. It is easy to make these preamplifiers hum free and of good, low distortion. Consequently transistorized microphone preamplifiers are simple and inexpensive items to manufacture.

But once again you will need to make sure the input and output impedance are suitable for the microphone and the recorder input respectively. As a good many lower priced microphones come either in alternative impedance ratings or with an adjustment to make the same unit adaptable to both, this would be no problem as long as you make sure you have the right impedance.

Dynamic Types

Microphones are usually typed by the kind of transducer element—the thing that converts sound waves into electrical currents—that the microphone uses. A dynamic microphone uses a moving coil and is like a moving coil loudspeaker, only very much smaller. It has a low-impedance basic element which may be stepped up by means of a built-in transformer. The simplest

type of dynamic microphone has what is known as an omnidirectional response—it picks up sounds coming from all directions almost uniformly, as shown in Fig. 3.

A good dynamic microphone, even of relatively low cost, has a fairly smooth frequency response and is better than the average microphone that comes with the tape recorder. From this viewpoint, however, because of its usually being omnidirectional, the sounds should never be more than about two feet away from the microphone otherwise it will tend to exaggerate echo effects from the room.

A small musical group could use one of these microphones by having the musicians arranged around the microphone so that all of them are fairly close to it. This is an unconventional arrangement for an orchestral group, but one that probably your friends may be prepared to adopt as a compromise in the interest of getting a good quality recording.

Dynamic microphones are also made in cardioid and other directional patterns. A cardioid response picks up principally from the front, with a fairly wide "fringe" at the sides, represented by the pattern of Fig. 2A. Some directional microphones have a super- or ultra-cardioid pattern in which the compensation is re-adjusted so as to get a narrower frontal response, as shown in Fig. 2B.

These pickup patterns are more useful for most work where you do not want to have the microphone too close to the source of sound—the musical group or the people speaking. Just point the microphone in their general direction and this will automatically reduce the amount of pickup from other directions.

Crystal and Ceramic Types

Crystal and ceramic type microphones always come in high impedance only. So, if your recorder has only a low impedance input, do not consider this type. However, as most home recorders do have high-impedance inputs, crystal or ceramic microphones can be employed. Their response is not quite as uniform, as a rule, as the dynamic

type, but a good crystal or ceramic type microphone can give very good results in combination with a home tape recorder and because of their inherently higher sensitivity any necessity for a preamplifier can often be avoided.

Crystal microphones have a higher sensitivity than the same model using ceramic, but for this loss in sensitivity with the newer type (about 5 to 8 db difference) ceramics can be designed with better response than crystals, and also ceramics are not so susceptible to excessive humidity and temperature extremes as are most crystals. Otherwise their properties are very similar.

Some of these microphones are produced with a cardioid response, which enables them to be directional and give the advantage of this particular characteristic. The cardioid construction with a crystal or ceramic device loses some of its inherent sensitivity, but a unit with "variable-D," or what the experts call constant-phase difference, achieves a sensitivity in the normal range. For some tape recorders these mikes will require a preamplifier.

Magnetic and Carbon Mikes

Controlled reluctance or magnetic microphones come pretty much in the same category as the lower cost crystal microphones and are used almost interchangeably with the low-cost microphones that come with the recorder. Their principal usefulness is for close talking as we have already mentioned. Carbon microphones, which are generally the least expensive type, probably have the lowest fidelity of response and may be troubled with carbon "hiss" or "packing." For this reason this type is not generally used as a recording microphone despite the fact that its output sensitivity is the highest of all the types.

Condenser Types

Condenser microphones fall into the "high-cost" bracket and have a performance that is usually much better than warranted with a home recorder. After all, there is no point in buying a very expensive microphone that pro-

(Continued on page 129)

Table 1. Summary of a number of important comparative characteristics of the general types of microphones discussed.

TYPE	PRICE RANGE	DIRECTIONALITY	SENSITIVITY	IMPEDANCE	FREQUENCY		APPLICATION
					RANGE	SMOOTHNESS	
Dynamic	Low-medium	Omni- or semi-	Medium-high	Any	Fair	Peaky	General purpose, medium quality
	Medium	Omni- or semi-	Medium	Any	Good	Good	General purpose, better quality
	Medium	Cardioid	Low-medium	Any	Good	Good	General purpose, more amplification needed
	High	Omni- or cardioid	Uses associated preamp		Excellent	Excellent	Broadcast, general purpose, high-level output
Crystal or Ceramic (see text)	Low	Omni- or semi-	Very high	High	Fair	Peaky	Voice and announcements
	Medium	Omni- or semi-	Medium-high	High	Good	Fair	General purpose, lower cost
	Medium	Cardioid	Medium	High	Good	Fair	General purpose, medium quality
Condenser	Expensive	Omni- or semi-	Uses a built-in preamplifier		Excellent	Excellent	Professional top quality, all-purpose, needs polarizing
Ribbon	Medium	Bidirectional	Low-medium	Any	Excellent	Excellent	High quality music and dialogue
	High	Cardioid	Low	Any	Excellent	Excellent	High quality music and dialogue
Magnetic	Very low	Omni- or semi-	High	High	Fair	Peaky	Voice and announcements
Carbon	Very low	Omni- or semi-	Very high	Low	Limited	Peaky	Mobile announcements—needs polarizing

Transistorized Code Oscillator

By **JOHN W. McDONALD**
Semiconductor Products Dept.
General Electric Co.

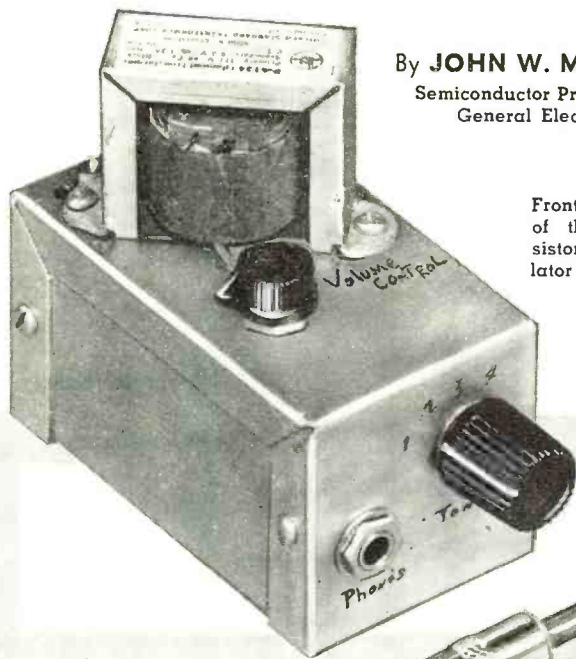

Front and rear views of the simple transistorized code oscillator described below.

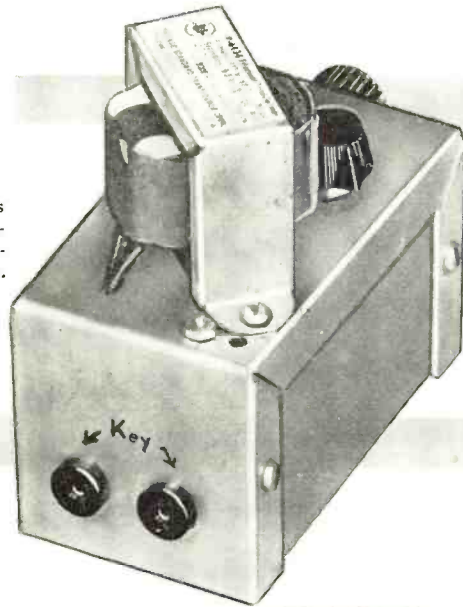

WITH the advent of any new electronic device, such as transistors, it's to the advantage of those who will be affected to familiarize themselves with the unit before it's commercialized. The usual procedure is to breadboard circuits similar to proven devices already in use (such as the vacuum tube) and evaluate the results. The oscillator is a basic circuit and can be readily transistorized.

The transistorized code oscillator to be described is a neat, compact unit. It can be built from standard, readily available parts. Both Old Timers and Novice ham operators can increase their speed and gain experience with transistors in the process. This unit is

Simple one-transistor circuit may be used for code practice or as basic audio signal source.

easy to construct. The major parts are often available in the "junk box" and the wiring and layout are not critical. The oscillator is mounted in a 2 1/4" x 4 1/2" x 2 1/4" "Minibox." The transistor is mounted inside the chassis to protect it from loss or damage during storage. The schematic diagram of the unit is given in Fig. 1. The 2N107 was chosen because of its availability and low cost. Several different types of junction transistors were tried with success. By reversing the

polarity of the battery, an *n-p-n* will work as well as the *p-n-p*.

The primary of a 6.3-volt, center-tapped, filament transformer is used as the collector load. When switch *S*₁ is closed, surge current passing through the transistor and primary starts oscillation. The induced signal is fed back to the base through *C*₁ to continue oscillation. The unit oscillates continuously and the signal is fed into the earphones by means of the key. (Continued on page 124)

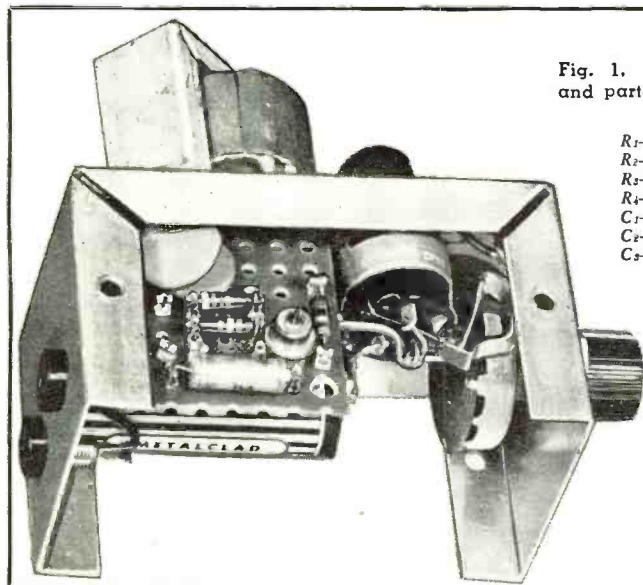
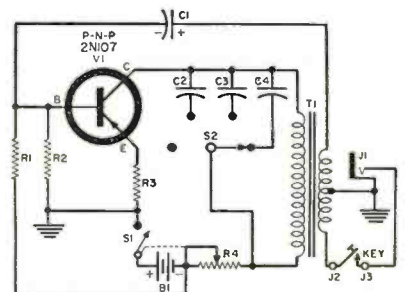

Fig. 1. Complete schematic diagram and parts listing for the code oscillator.

- R*₁—20,000 ohm, 1/2 w. res.
- R*₂—25,000 ohm, 1/2 w. res.
- R*₃—470 ohm, 1/2 w. res.
- R*₄—10,000 ohm pot (with switch *S*₁)
- C*₁—5 μfd., 6 v. elec. capacitor
- C*₂—.006 μfd., 200 v. capacitor
- C*₃—.004 μfd., 200 v. capacitor

Bottom view of the simple one-transistor code oscillator is shown here. Tone control switch *S*₂ is at the right while the volume control *R*₄ is mounted on top of the little chassis. Small components, including transistor, are mounted on the board as shown.



- C*₁—.02 μfd., 200 v. capacitor
- S*₁—S.p.s.t. switch (on *R*₁)
- S*₂—S.p. 4-pos., non-shorting switch (Mallory 3215J)
- J*₁—Phone jack (Mallory "Infant," open-circuit type, 41H-054)
- J*₂, *J*₃—Pin jack
- B*₁—3-volt battery
- T*₁—Fil. trans. 6.3 v., c.t. @ 1.2 amp. (Stancor P-6134)
- Chassis—2 1/4" x 4 1/2" x 2 1/4" "Minibox"
- V*₁—"p-n-p" junction transistor (2N107 or equiv., see text)

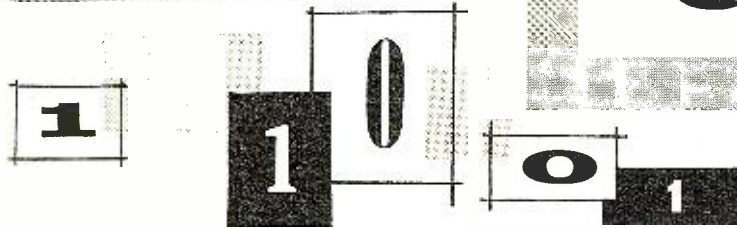
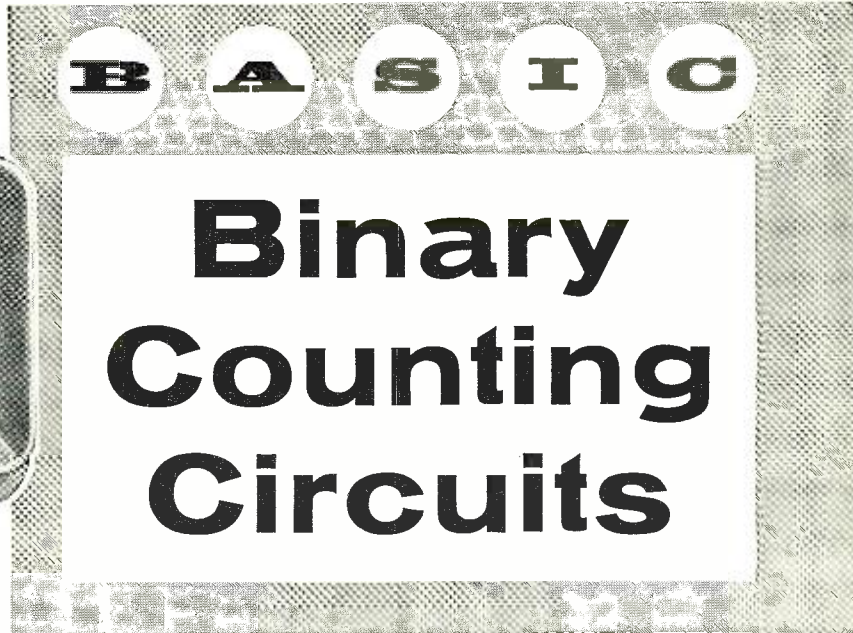

Fig. 1. Used for counting the pulses of a Geiger counter, this Nuclear-Chicago scaling unit includes 8 flip-flop stages and indicates by 8 neon lamps plus a mechanical counter (top left).

An appraisal for technicians of the fundamental, binary-counting flip-flop and how it is applied.

MUCH of the usefulness of a flip-flop stage derives from its ability to produce one output pulse for every two pulses applied to its input. When an input pulse is applied to a twin-stage flip-flop, the tube which was previously conducting becomes cut off and the tube which was cut off becomes conductive. A second pulse applied to the input will again reverse the circuit, restoring it to its original condition. Since one complete cycle of operation requires two input pulses, an output taken from the circuit may be said to have a frequency only half as great as the frequency of the input pulses.

A flip-flop stage and its input and output waveforms are shown in Fig. 2. Assuming that the circuit starts in the zero condition (left-hand tube cut off and right-hand tube conducting), the following changes will occur when

the first negative pulse is applied to the input: The negative input pulse (waveform A) is fed to both grids but has no effect at the left-hand grid, since this tube is already cut off. Arrival of the negative pulse at the right-

EDITOR'S NOTE: This straightforward presentation takes no previous knowledge for granted of the circuitry that has become fundamental to modern electronic counting and computing equipment. The method of counting by "ones" and "zeros"—the binary counting technique—is used in preference to the more familiar decimal system because the former is better suited to available circuits. For a discussion of binary notation itself, see "Basic Electronic Counting" in our issue of March, 1958.

hand grid drives this tube toward cut-off. The resultant increase of voltage at the right-hand plate is coupled to the grid of the left-hand tube and causes this latter stage to conduct.

When the left-hand tube conducts, its plate voltage decreases. This decrease is coupled to the right-hand grid, which is, in turn, thus driven to cut-off. The first input pulse therefore switches the circuit to the one condition (left-hand tube conducting and right-hand tube cut off.) As the right-hand tube cuts off, its plate voltage increases as shown in waveform B.

When the second negative input pulse is applied to the circuit, it cuts off the left-hand tube and the increasing plate voltage of this stage causes the right-hand tube to conduct. The circuit is now back to the zero condition. When the right-hand tube conducts, its plate voltage decreases as shown in waveform B.

The output signal of this stage is coupled through a small capacitor from the plate of this right-hand tube. This small capacitor, in conjunction with the input resistance of a following stage, provides differentiating action due to the short RC time constant. As a result, waveform B becomes peaked as shown in waveform C. A comparison of waveform A and C reveals that two negative pulses applied to the input will produce only one negative pulse at the output. It is for this reason that the flip-flop stage is often referred to as a 2-to-1 frequency divider.

When the input to a flip-flop is applied to the grids in the manner shown in Fig. 2, negative input pulses are used to trigger the circuit. Positive pulses may be used instead, but a greater amplitude is required. One of the reasons for this is that some of the amplitude of the positive pulse is wasted in bringing the tube from below cut-off up to the cut-off level, and

PULSE	CONDITION OF FLIP-FLOPS				LIGHTS ON
	4th stage	3rd stage	2nd stage	1st stage	
0	0	0	0	0	0
1	0	0	0	1	1
2	0	0	1	0	2
3	0	0	1	1	1+2
4	0	1	0	0	4
5	0	1	0	1	1+4
6	0	1	1	0	2+4
7	0	1	1	1	1+2+4
8	1	0	0	0	8
9	1	0	0	1	1+8
10	1	0	1	0	2+8
11	1	0	1	1	1+2+8
12	1	1	0	0	4+8
13	1	1	0	1	1+4+8
14	1	1	1	0	2+4+8
15	1	1	1	1	1+2+4+8
16	0	0	0	0	0

Table 1. The conditions of the flip-flop stages indicate the number of pulses stored in the circuit. For example, after the 13th pulse is applied, the binary number 1101 is recorded. This is the equivalent of decimal number 13.

the switching action does not begin until the tube is brought above cut-off.

Fig. 3 illustrates several other commonly used methods of applying triggering pulses to a flip-flop stage. When the input pulses are applied to the cathodes as shown in Fig. 3A, the circuit will respond only to positive input pulses. This positive input to the cathode cuts off the tube that was previously conducting. As the tube cuts off, its plate voltage increases and drives the opposite grid more positive. The use of diodes for coupling the input pulses is shown at Fig. 3B. Since the input pulses are applied to the cathodes of the diodes, the circuit will respond only to negative triggering pulses.

The coupling diodes automatically channel the negative input pulse to the grid of the conducting triode. This happens because, for any given condition of the flip-flop, one of the diodes will be cut off. For example, when the left-hand triode is conducting, its plate voltage will be low. This makes the plate of the associated (lower) diode less positive than its cathode, which is connected to "B+". The input pulse therefore cannot pass through this diode. The other (upper) diode, however, couples the input pulse to the plate of the right-hand triode—and consequently to the left-hand grid.

In the triggering method illustrated in Fig. 3C the input pulses are applied to the junction of the plate-load resistors and an additional resistor connected in the "B+" line. This circuit, which responds only to negative input pulses, provides a high input impedance to reduce loading of the preceding circuit.

A single flip-flop stage produces a 2-to-1 ratio of frequency division. If two flip-flop stages are connected in

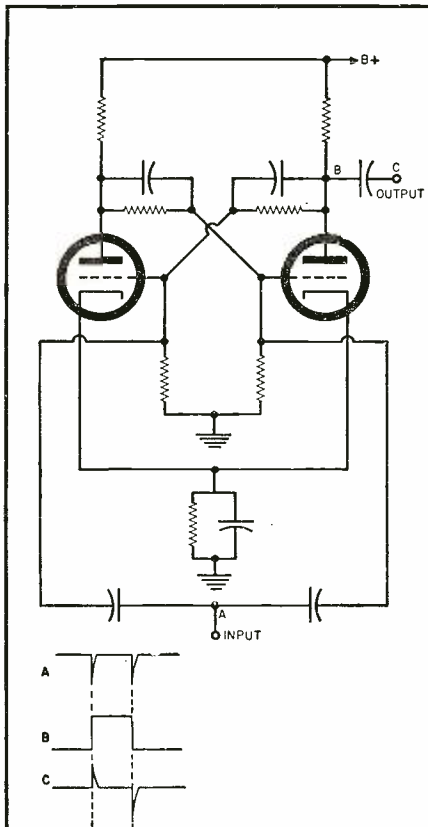

Fig. 2. A flip-flop stage with its input and output waveforms. Two input pulses result in a single output pulse.

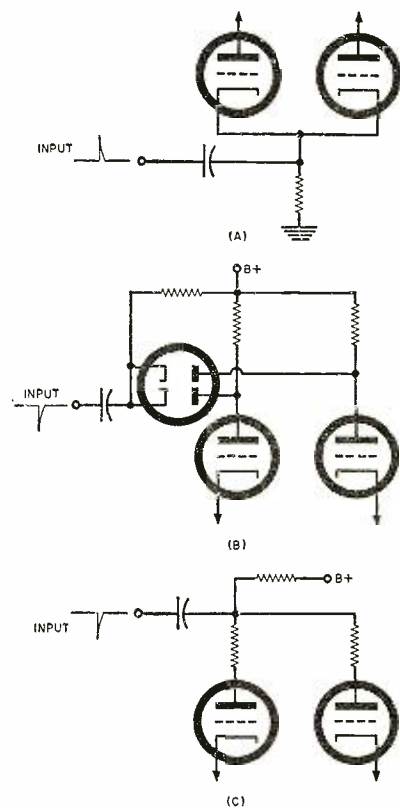

Fig. 3. Commonly used methods for applying negative or positive triggering pulses to conventional flip-flop stages.

cascade (the output of the first stage providing the input for the second), the second stage will produce an output pulse after four pulses have been applied to the first circuit. Three flip-flops in cascade will divide the input frequency by 8, four stages will have a ratio of 16, five stages 32, etc. Since

each additional stage *doubles* the ratio of frequency division, the total ratio of division for any number of stages will be 2^n where n is the number of stages.

Fig. 4 shows four flip-flop stages in cascade. The reset switch is used to

Fig. 4. With four cascaded flip-flop stages, 16 input pulses must be applied to produce a single output pulse.

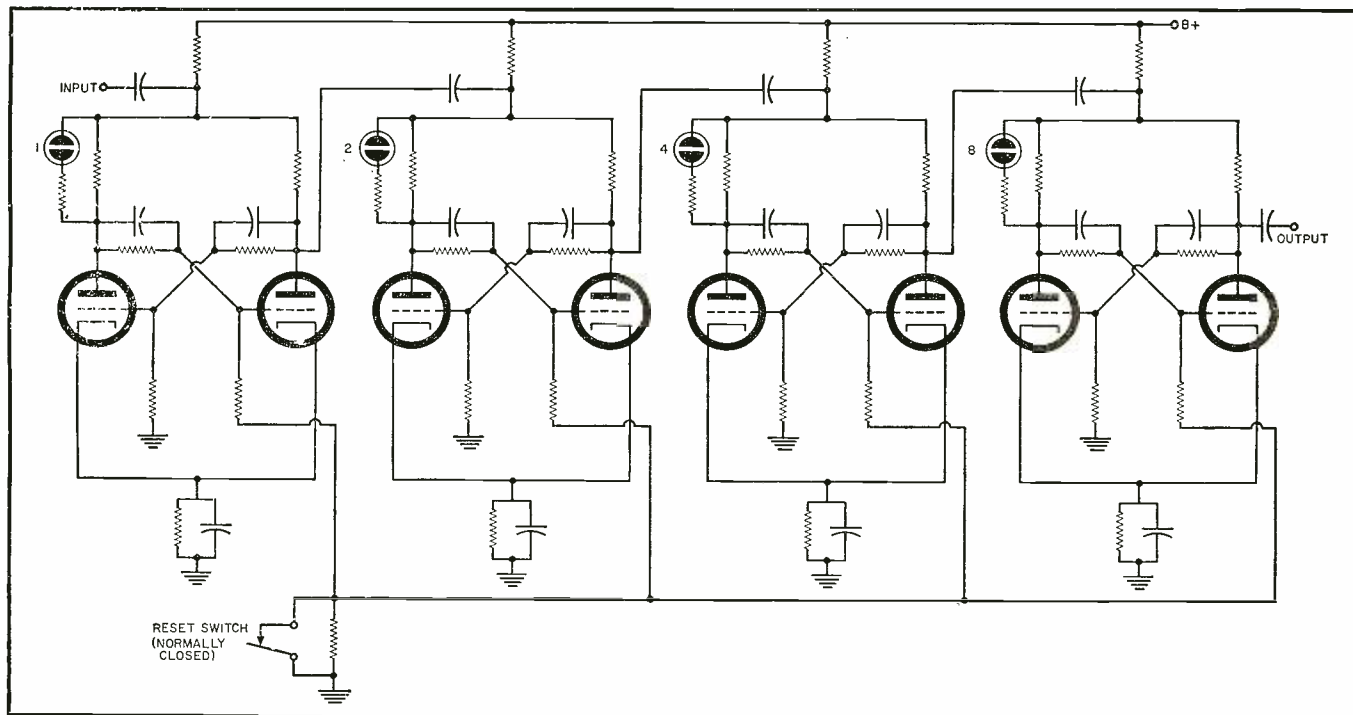

Testing

By WALTER H. BUCHSBAUM

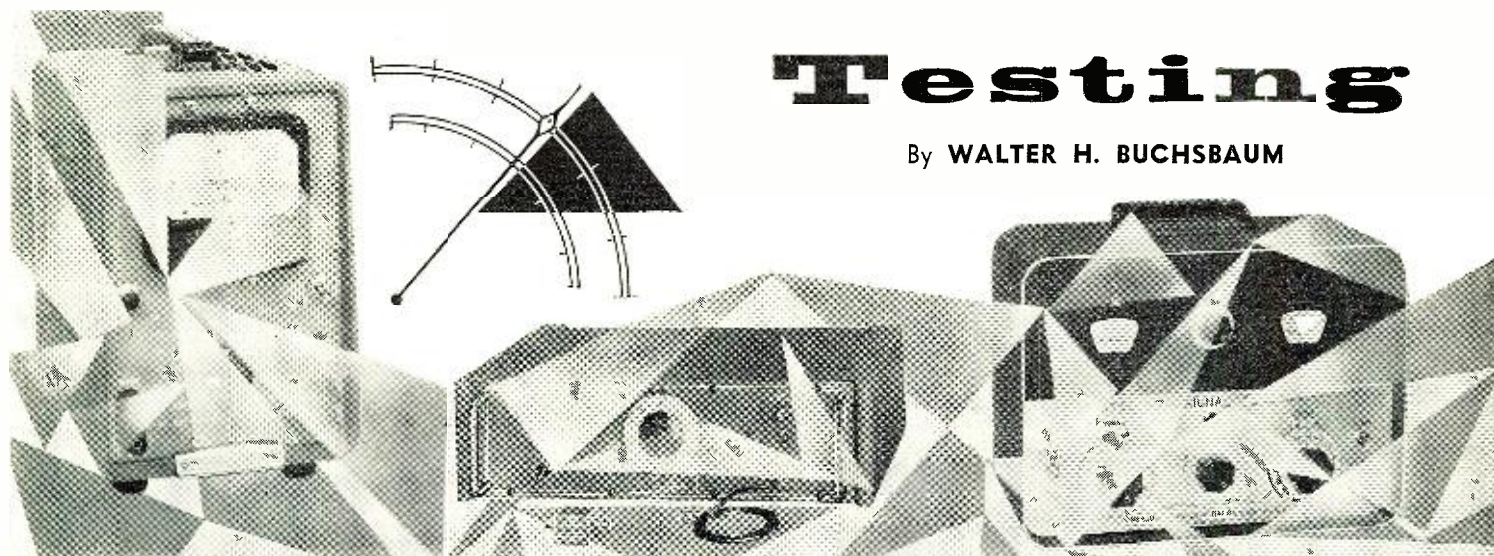

THERE are many FM tuners on the market today, in both kit and assembled form and each is offered with a set of electrical specifications which should determine its performance. These specifications are sometimes based on tests devised by the manufacturer but usually the published figures are obtained by standard test methods.

The Institute of Radio Engineers (IRE) publishes the findings of various groups, coordinated by the Standards Committee, and the reference on FM receivers is the publication "Methods of Testing Frequency Modulation Broadcast Receivers," 1947. In this standard all applicable tests are described and agreed methods for performing them are presented. Many of these tests deal with the acoustical portion of the FM set and therefore do not apply to FM tuners. Other tests, such as the one on masking interference or local oscillator radiation, are not important enough to the set owner to warrant specifications.

The technically minded purchaser of an FM tuner may wonder at the meaning of some of the specifications the manufacturer publishes or he might try to duplicate these results in his own performance tests. Conflicting claims of excellence may often be due more to varying test methods than actual electrical differences. This article describes twelve tests, listed in the IRE standards and usually performed in evaluating FM tuners. The reader must be warned, however, that the equipment required for most of these tests is usually available only in well equipped development or testing labs.

Standard Values

For FM tuners there are certain standard values which will be referred to many times and which are commonly used in all performance tests. The most important of these are: the standard input impedance which is 300 ohms; standard test frequencies which are 88, 98, and 108 mc.; and standard input voltages. These range from 11,

A review of the standard laboratory procedures that should be used to measure and check tuner specifications.

110, and 1100 microvolts up to 1.1 volts. The standard test modulation of the input signal is 400 cycles at 30% which means that the r.f. signal varies in frequency ± 22.5 kc.

Test Equipment

The most important piece of test equipment is the signal generator. In addition to being stable and having an accurately calibrated frequency dial, this generator must also have a number of other features. It must cover the 88 to 108 mc. frequency band and the adjacent ranges. To cover the 10.7 mc. i.f. band a second generator is usually used. A metered output attenuator, calibrated from 0.1 microvolt to 1.1 volts as well as frequency modulation, metered from zero to 100%, should be part of the generator. Either external or internal modulation from 30 to 15,000 cps should be possible and the modulator should contain the standard 75 microsecond pre-emphasis network, including a disabling switch for it.

To match the 300-ohm tuner input, the generator should either have a balanced 300-ohm output or else a

cable and termination must be used to change the 50-ohm output to a 300-ohm balanced system. The loss in this conversion must be accounted for in all output readings.

To check the output of the FM tuner a v.t.v.m. and an oscilloscope will be required. Since the IRE standards were written for complete FM receivers, all output measurements were made at the loudspeaker, hence the conventional audio distortion analyzers, power output meters, and dummy loads were used. In this respect some modification of the standards is necessary. Distortion will have to be measured either by analyzers or by eye on the oscilloscope and, in place of power output, the usual cathode-follower output signal will be metered.

One of the important items in measuring tuner performance is a dummy antenna. Fig. 1 shows the typical circuit of such a network as connected to the 300-ohm balanced generator. The resistors used should all be of the $\frac{1}{2}$ watt, 5% carbon type and all leads should be as short as possible.

Practically all FM tuners use 117-volt a.c. power and, in testing them, the line voltage should be measured and set to 117 volts at all times. Use of a metered *Variac* makes this convenient to arrange, otherwise the line voltage must be checked several times during each test.

Before proceeding with any of the following performance tests the tuner should be carefully aligned and tracked at several points in the band, but at least at the standard test frequencies already listed. For this alignment check it will be necessary to remove the tuner from the cabinet and all further tests will be done on the open chassis. Only if all tubes are in place and the set is working properly with the regular antenna,

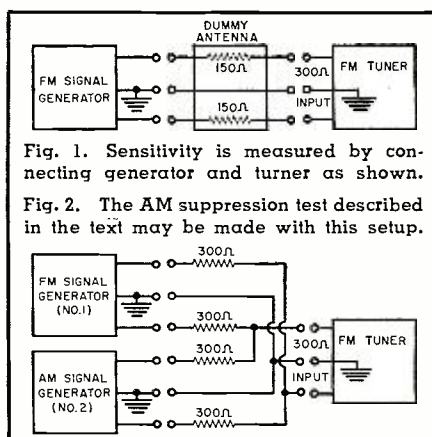
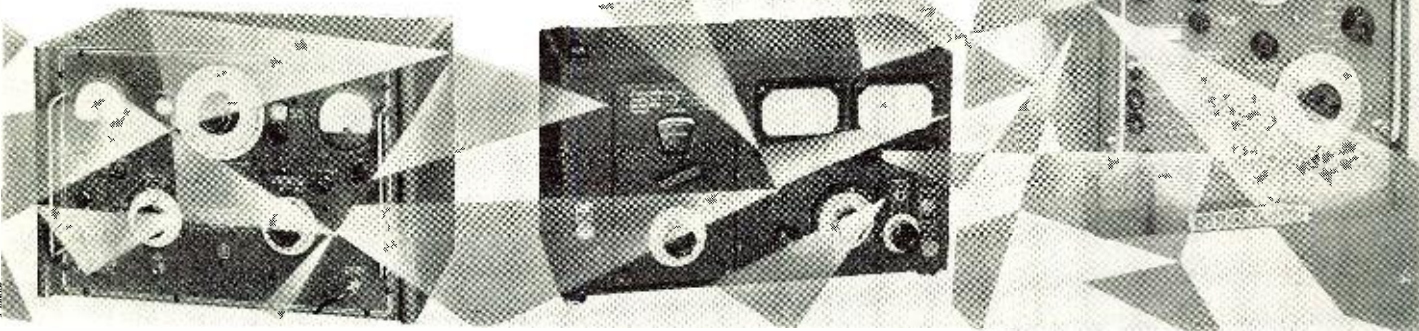

Fig. 1. Sensitivity is measured by connecting generator and tuner as shown.

Fig. 2. The AM suppression test described in the text may be made with this setup.

FM Tuners

Some of the accurate and specialized lab test equipment used for testing.



can these tests be readily performed.

1. *Tuning Range Test:* First the tuner frequency control is checked for smooth operation over the band. Then connect the signal generator to the tuner through the dummy antenna as shown in Fig. 1 and set the tuner to the highest frequency. Connect the v.t.v.m. to the FM detector output and, with the generator at c.w. (unmodulated), tune the generator until the v.t.v.m. goes through zero. In the same way check the frequency at the low end of the tuner dial. All FM tuners should cover at least from 88 to 108 mc. preferably with a few megacycles at either end. If the FM tuner has a calibrated tuning dial, the dial reading should be compared to the generator reading at least at the standard test frequencies of 88, 98, and 108 mc.

2. *Sensitivity Test:* Three different sensitivity values can be considered as giving an indication of FM tuner performance and a fourth measurement is taken to give an indication of the audio stage limitations on the i.f. system.

(a). Maximum sensitivity is measured by connecting the generator and tuner as shown in Fig. 1 and connecting the v.t.v.m. to the audio output jack. To make the measurements exact, the oscilloscope or a distortion analyzer should also be connected to the tuner output. All tuner controls are set for maximum gain and then the tuner and generator are tuned, in turn, to each of the three test frequencies. The generator output should be set to the standard test modulation which is 400 cps at 30%, or 22.5 kc. deviation. In FM receivers the output is standard at 0.5 watt of audio power into a dummy load and for FM tuners the most widely used value is either 1 or 3 volts r.m.s. at the output jack, depending on the manufacturer's data. The purpose of the scope or analyzer is to make sure that the 400-cps signal is free from distortion. The signal generator attenuator is adjusted to produce either 1 or 3 volts r.m.s. at

the output jack and the microvolts thus supplied constitute the maximum sensitivity. Needless to say, correct tuning is essential. It may happen that receiver noise is so great at maximum gain that it obscures the signal. This should be noted and another reading can be taken for the generator setting where the received signal is twice as large as the noise. Usually the tuning position for minimum noise and minimum distortion coincides, but if two different spots on the frequency scale are involved, this should be noted.

(b). Maximum deviation sensitivity is measured with the signal generator set to 100% or ± 75 kc., but otherwise in the same manner as just described. The generator output is adjusted at each test frequency to give 10% distortion at the tuner output jack, as measured on the oscilloscope or distortion analyzer. Vary the generator output attenuator until the output is either 1 or 3 volts or until only 10% distortion is apparent, whichever is the higher generator output reading. This reading, in db below 1 watt or in microvolts, is the maximum deviation sensitivity.

(c). For the deviation sensitivity test the generator is set only to 98 mc., the output is set for 90 db below one watt or to 1100 microvolts and the deviation is varied from 0 up to that value which produces 1 or 3 volts r.m.s. at the tuner. The value obtained is expressed either in kilocycles or per-cent.

(d). "Quieting signal sensitivity" gives an indication of the degree of internal receiver noise during moments when the received signal is not modulated. The generator is tuned, in turn, to the three test frequencies and, with 400 cps, 30% modulation, the attenuator is set for 1100 μ v. output. The modulation is then turned off and the tuner output reading is noted. With standard test modulation on again, set the attenuator to a minimum value so that the tuner output reading is about 30 times (30 db to be exact) the reading with unmodulated input. This attenuator setting, in microvolts or db below one watt, is then the quieting signal sensitivity for 30 db quieting.

3. *AM Suppression Test:* This important test measures the degree to which a tuner can reject AM interference appearing together with the desired FM signal. Either a generator having simultaneous AM and FM available or two separate signal generators are required. In the latter instance connections should be made as shown in Fig. 2 and the output signals, as measured at the generator, will be half of the actual applied signal. At 98 mc. an FM signal, 1000 cps at 30% modulation, is fed through the dummy antenna at 1100 μ v. If the circuit of Fig. 2 is used, the generator should deliver twice the output voltage. Then the FM tuner volume control is adjusted to produce 1 or 3 volts r.m.s. output at the jack. Next the AM signal is introduced having a 400 cps, 30% amplitude modulation and the same generator output voltage. If two generators are used they must be tuned very precisely to avoid beat notes. The AM signal should be free from any FM content. Now it is necessary to insert a 1000-cps rejection filter at the tuner output jack. In many instances where a suitable filter is not available the 400-cps output can be measured on the scope, if the scope is synchronized at 400 cps. The ratio of the undesired 400-cps output to the 1 or 3 volts standard

Fig. 3. Typical a.v.c. characteristic.

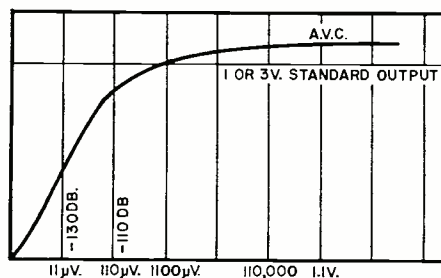

FM output is the AM suppression in db. To indicate how the suppression characteristic varies with input level the measurement can be repeated at the other standard input signal levels such as, 11, 110 $\mu\text{v.}$, etc. Typical values of AM suppression with 1100 $\mu\text{v.}$ input are between 30 and 40 db.

4. *Harmonic Distortion Test:* With the FM tuner set at 98 mc. and the signal generator connected through the dummy antenna as shown in Fig. 1 several different indications of distortion can be obtained. Precise distortion measurements can best be made by means of a distortion analyzer, but for approximate readings visual observation on the scope may be enough.

(a). Output variation. With the signal generator set at 400 cps 30% modulation and 1100 $\mu\text{v.}$, vary the volume control to produce different output levels. Different degrees of distortion will be observed and they indicate the audio distortion due to the audio section.

(b). Modulation distortion is measured as previously described but the volume control is set for 1 or 3 volts r.m.s. output and the modulation percentage is varied at the generator from 10 to 100%. This measurement gives an indication of the r.f. and i.f. bandwidth and the linear response of the detector.

(c). Input signal variation from 11 $\mu\text{v.}$ up to 1.1 volts, with both 30 and 100% modulation, indicates the action of the a.v.c. and bandpass response. The output signal is kept constant at either 1 or 3 volts r.m.s. by adjusting the volume control.

(d). Modulation frequency distortion is best checked with a generator having external modulation which is supplied by an audio oscillator. This test can be performed by repeating the tests of (a) and (b), but with different audio frequencies ranging from 30 to 20,000 cps, at 30% modulation and standard input and output signal values.

5. *Maximum Undistorted Output:* This test has generally more meaning for complete FM and audio systems since in FM tuners the audio output voltage is not critical. The test for harmonic distortion listed in paragraph (4a) is simply modified by setting the volume control to that output level where the total harmonic distortion is just 10% (r.m.s. voltage) of the output signal. This signal voltage is then the maximum undistorted output.

6. *Maximum Output:* Again this test is useful mostly in evaluating a complete FM receiver and all it tells about the FM tuner is what the maximum output voltage of the cathode follower is, irrespective of distortion.

7. *A.V.C. Characteristics:* This is determined by setting the volume control to produce half the maximum possible output with each of the following generator settings: 11, 110, 1100, 11,000, 110,000 $\mu\text{v.}$ and 1.1 volts

output, at 400 cps, 30% modulation at 98 mc. By plotting the values of output signal, in each instance, against the input voltage, a curve like the one of Fig. 3 is obtained and this represents the a.v.c. characteristic. Note that with increasing input signals the output of the FM tuner tends to remain constant, which is due to both a.v.c. and the limiting action of the limiter stage.

8. *Spurious Responses:* This test consists simply of tuning the signal generator over a wide frequency band to see if the FM tuner will pick up undesired frequencies. Certain known spurious responses are unavoidable, but their signal strength would have to be quite large to interfere. Each spurious frequency is noted first and then the test described in paragraph (2a), the maximum sensitivity test, is performed for each spurious frequency. Normally, all such undesired frequencies should have sensitivity readings at least 60 db below the desired response. There is one particular response that is inherent in the superheterodyne system and that is the image response. This occurs at a frequency 21.4 mc. above the desired signal and is due to the beat of the local oscillator with a signal 10.7 mc. higher. For most FM tuners the image response should be better than 45 db below the desired response. If, for example, the maximum sensitivity of the tuner is 11 $\mu\text{v.}$, the image sensitivity should be less than 3300 $\mu\text{v.}$

Another undesired frequency which will always be received is the i.f. itself. To check the receiver sensitivity for the 10.7 mc. i.f. a generator supplying this signal must be used. This generator is connected through the standard dummy antenna and the maximum sensitivity test is performed. Results should be better than the image response sensitivity.

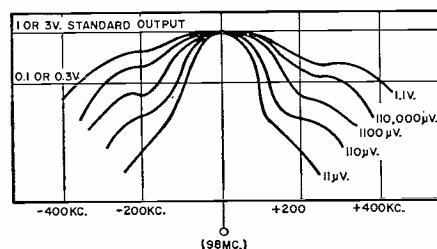
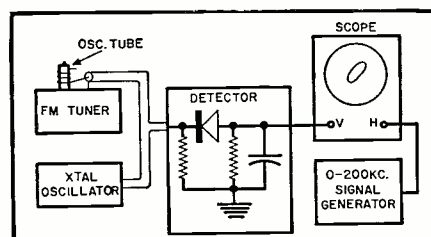

Fig. 4. Curves showing the over-all frequency response of an FM tuner at various signal levels. Note the wider over-all response at higher inputs.

Fig. 5. Method employed to check the drift of the oscillator in the FM tuner being checked. A crystal diode scope probe is used to detect the beat.



9. *Measurement of Hum:* For complete FM receivers, the hum measurement provides an indication of the audio system quality as well as the tuner performance. When the audio section alone is tested for hum, the simplest way to check is to use the oscilloscope as an indicating device. The scope should be sensitive enough to show at least 0.01 volt peak at measurable amplitude. First, short the tuner antenna terminals together, set the volume control to minimum and the tone control for maximum hum. The scope is connected to the audio output jack and the horizontal sweep synchronized to the 60-cps power line. Hum voltages observed are peak values but, in specifications, hum is usually stated in r.m.s. so that the actual peak-to-peak reading has to be divided by 2.8. A second test which will check the entire tuner can be made with the tuner connected to the signal generator and tuned exactly for the 98 mc. test frequency with 1100 $\mu\text{v.}$ input. With the standard 30% modulation on, adjust the volume control for the standard 1 or 3 volts output. Then turn the modulation off and measure the hum signal on the scope. In this way the ratio of hum to signal can be determined. Most FM tuners will have less than .05 volt peak hum output.

10. *Tuning Characteristic Test:* This test gives some indication of the overall frequency response of the FM tuner at different signal input levels. At the 98 mc. test frequency the tuner volume control is set for standard 1 or 3 volts output and the generator for one of the standard input levels, 11, 110, 1100 $\mu\text{v.}$, etc. Then the generator is detuned in 25 kc. steps above and below the 98 mc. center frequency. The output amplitude is then plotted on a graph against frequency, as shown in Fig. 4. A separate curve is taken for each level of input. As the input signal increases it is natural for the apparent bandwidth to increase as well.

11. *Tuning Indicator Test:* Many of the more expensive FM tuners have some type of tuning indicator. Where a tuning eye tube is used, the percentage of non-illuminated area is an indication of the error in tuning. When a meter is used, the needle deflection gives the same information. To test the accuracy of these devices the same test as in paragraph (10) is performed, but instead of recording the output signal variation the action of the tuning indicator is noted. The point where the tuning indicator shows completely "off station" should coincide with the 100 kc. above and below center points for accurate tuning.

12. *Frequency Drift Test:* The local oscillator drift can be ascribed to two major causes. First is the inevitable warm-up drift and second is due to variations in line voltage and subsequent "B+" and filament changes.

(Continued on page 131)

A Transistorized Electronic "Accordion"

Can be used to play simple melodies and doesn't even have to be squeezed.

IN MANY respects, electronics and music are compatible fields. Electronic audio equipment is used to amplify the voices of singers and the efforts of musicians; electronic radio and television equipment makes it possible to distribute the renditions of famous orchestras, instrumental groups, and singers to immense numbers of listeners; and, finally, electronic sound recording and reproduction equipment can preserve original musical performances for years while, at the same time, permitting an almost unlimited number of "encores."

Many different types of electronic musical instruments have been devised in the past. Relatively few of these have "caught on" with the general public or with professional musicians, however. It would not be too difficult to count the really popular instruments on the fingers of one hand. The electric guitar, the electric organ, and the Theremin are probably the best known electronic instruments and, of these, the Theremin is used primarily for special concerts and for background music or unusual sound effects on radio and TV programs and in the theater.

Thus, while electronic equipment has been used extensively to amplify, to distribute, and to record music, specialized electronic music-making instruments have never achieved really widespread popularity.

That electronic instruments can remain so "unpopular" in a gadget-conscious atomic age is rather surprising, especially since advanced electronic instruments, in theory at least, are capable of producing a much wider range of frequencies, of tonal shadings, and of amplitude and pitch variations than can conventional instruments.

The explanation for this situation probably lies in the essentially "personal" quality of music. Except for the piano, organ, and a few of the larger units, a musician using a conventional instrument can literally take his "music" with him wherever he goes. He can play his cornet, trumpet, accordion, piccolo, ocarina, saxophone, harmonica, trombone, violin, clarinet, or oboe wherever he pleases . . . on picnics, at church outings, in his room at night, at a jam session with his cronies, on a concert stage, or in a conservatory classroom. He

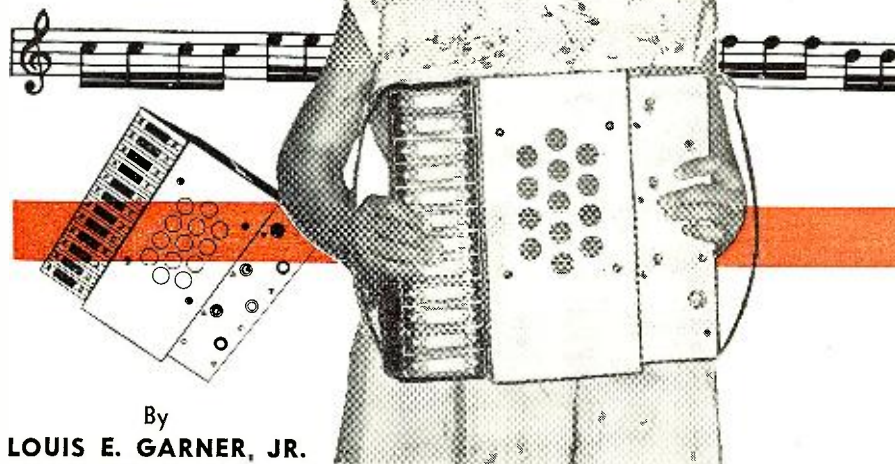

By
LOUIS E. GARNER, JR.

needn't worry about finding a "convenient" source of line power nor need he be concerned with dangling cables and cords which might limit his freedom of movement. And he doesn't have to check on whether d.c. or a.c. (or the frequency of a.c.) power is available before accepting a playing engagement.

Essentially, then, since most conventional musical instruments are fully self-contained and, in this sense, are completely portable, they are really "personal" instruments. On the other hand, electronic instruments, in the past at least, have required an external source of electric power, plus, in some cases, external loudspeaker and amplifier units and bothersome cables and wires.

Self-contained portable vacuum-tube operated instruments can be designed, of course, but they generally require heavy, short-lived, expensive battery power packs. In most cases, the power pack may actually weigh more than the instrument itself.

When low-power transistors were first introduced, they offered real possibilities—lightweight, physically small, rugged, and requiring relatively little current at low voltages, these seemed ideal for portable instrument applications. But it soon became apparent that such transistors could not deliver adequate audio power levels. To be practicable for general use, an electronic musical instrument should deliver its output at good room volume.

Today, however, with the mass commercial production and ready

availability of low-cost power transistors, it becomes feasible to design a truly self-contained electronic musical instrument, that is, one which can be used to play genuine tunes, which will deliver good volume, which is not excessively heavy, and which has adequate battery life. The electronic "accordion" shown in the photographs represents a basic step in the design of such instruments.

Although designed primarily to demonstrate the possible use of power transistors in the construction of electronic instruments, the "accordion" is an effective basic instrument and can be used to play popular tunes and melodies. With a special tonal quality of its own which distinguishes it from its similar appearing "cousin," the conventional reed accordion, the instrument is held and operated in much the same manner as the conventional instrument, with an important exception—no "squeezing" is necessary.

Using readily available parts, the electronic "accordion" is inexpensive and easy to assemble and not only makes an interesting construction project for the experimenter, gadgeteer, or home builder but also makes an excellent "toy" for an older boy or girl. Youngsters as young as five or six years can have a lot of fun playing with it, even if they don't produce recognizable tunes.

Circuit Description

The schematic wiring diagram for the instrument is given in Fig. 1. Referring to this diagram, we see that the "accordion" uses a single CBS-

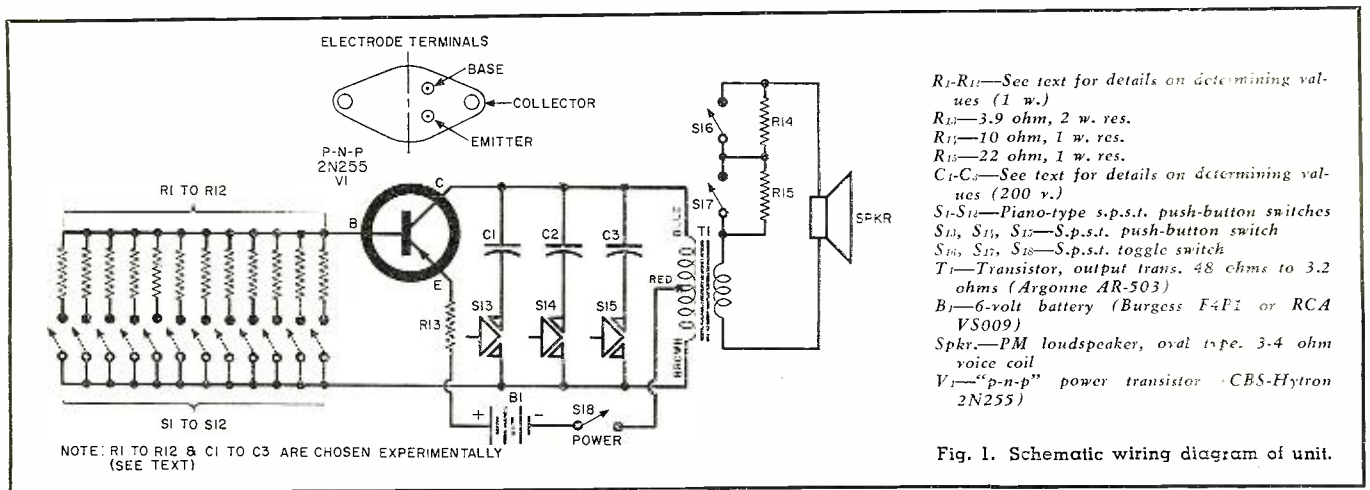

Hytron type 2N255 *p-n-p* power transistor in a common-emitter audio oscillator circuit.

In operation, center-tapped power output transformer T_1 serves a dual function; it matches the collector-emitter impedance to the low impedance of the PM loudspeaker's voice coil and also serves to provide the feedback necessary to start and sustain oscillation. Operating power is supplied by a single 6-volt battery, B_1 , controlled by a s.p.s.t. power switch, S_{18} . Unbypassed emitter resistor R_{13} helps to stabilize circuit operation and prevents collector current "runaway" when the instrument is used at moderately high ambient temperatures.

Since the oscillator transformer (T_1) is center-tapped, it provides considerably more feedback between collector and base circuits than the "minimum" required to insure oscillation and the circuit functions as an overdriven oscillator. This results in several operating characteristics which are desirable in an instrument of this type.

First, instead of a monotonous sounding sine-wave, the unit delivers a signal rich in harmonics which has a unique musical quality. In addition, the oscillator's operating frequency (pitch or tone) can be varied either by changing the circuit's *LC* characteristics or by changing the loading on the oscillator. In practice, both are varied to obtain desired notes and tonal variations. Finally, the signal level (or volume) remains essentially constant as different notes are played.

The oscillator's operating frequency can be varied in either of two ways. As any of the "piano-key" s.p.s.t. switches S_1 to S_{12} are closed, different values of fixed resistance (R_1 to R_{12}) are connected in series with the transistor's base electrode. This varies both the base bias current and the loading on transformer T_1 . In addition, since base bias current variations cause corresponding changes in collector current levels, but of greater magnitude, the d.c. through T_1 's primary winding changes and the inductance of this component varies. The net result is that the frequency of the oscillator drops as lower values of base resistance are used.

The instrument's frequency can also be varied by changing the circuit's *LC* characteristics. In practice, this is accomplished by using s.p.s.t. push-button switches S_{13} to S_{15} to shunt different values of fixed capacitance (C_1 to C_3) across T_1 's primary winding. As larger capacitor values are used, the operating frequency becomes lower.

For special effects, both the base bias resistor and the shunt capacitor can be changed together simply by closing one of the resistor switches (S_1 to S_{12}) and one or more of the capacitor switches (S_{13} to S_{15}) simultaneously. Since the transistor requires some base bias current to operate, the circuit will not oscillate (or produce a signal) unless at least one of the base resistor switches is depressed, even if the power switch (S_{18}) is closed.

Two fixed resistors, R_{11} and R_{15} , are connected in series with the loudspeaker's voice coil. Generally these are shorted out of the circuit by shunt switches S_{16} and S_{17} , which remain "closed" during normal operation of the instrument. When either switch is opened, its corresponding resistor is automatically connected in series with the voice coil, reducing the signal delivered to the loudspeaker and thus output "volume." These "volume" or "loudness" switches are used to reduce signal level for solitary practice or for special effects. A slight change in tone may occur as these switches are operated.

Construction Hints

With neither component layout nor circuit lead dress critical, a prospective builder of the "accordion" can either follow the general layout of the author's model, as shown in the photographs, or can make up a new layout to suit his own inclinations. Irrespective of the layout chosen, care should be taken that resistors R_1 to R_{12} and capacitors C_1 to C_3 are readily accessible and that the power supply battery B_1 can be removed and replaced without difficulty.

The "accordion-like" appearance of the author's instrument was achieved by using piano-key push-button switches for S_1 to S_{12} (available at

local hardware stores) and by making up a special case with a large control "body" and two smaller "wings." A single 3" deep aluminum chassis was used for the "body," with a pattern of large holes punched in it to form a grille for the oval loudspeaker. The slightly shorter "wings" were made by cutting a 2" deep chassis in half lengthwise and forming mounting lips along the cut edges. All three chassis were assembled together using standard machine screws, hex nuts, and lockwashers.

Although hand-made, the finished case will look professionally built if properly finished. Two coats of enamel or clear acrylic plastic should be applied to the case after all machine work and case assembly is finished, but before parts are mounted or wiring started. For a finishing touch, leather strap handgrips can be added,

Main chassis and two side (keyboard) chassis. Dimensions are not critical.

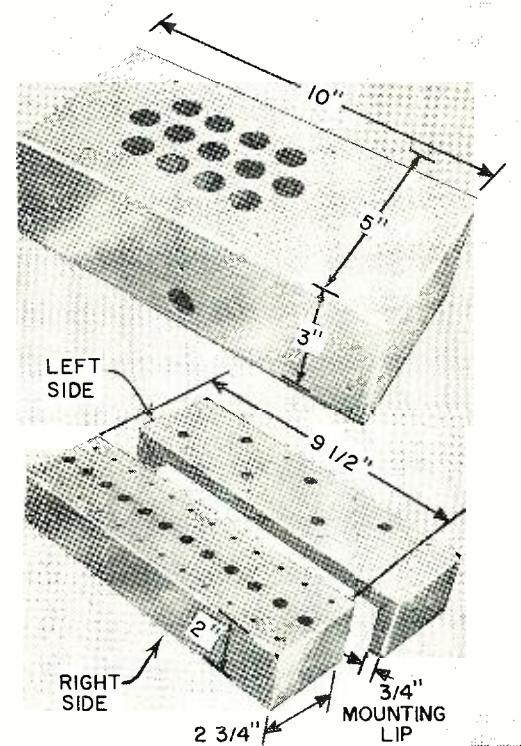

with a neck strap provided if desired.

The 2N255 power transistor is mounted on a small piece of aluminum which serves as an effective heat sink for its collector electrode. This "subchassis" must be electrically insulated with respect to circuit ground and other wiring to prevent accidental shorts. In the model, this was accomplished by mounting the heat sink chassis on a strip of perforated Masonite. The insulating strip, in turn, was mounted to the main chassis by means of small "L" brackets.

Since the values of resistors R_1 to R_{12} and capacitors C_1 to C_3 are determined experimentally after all wiring is finished and the instrument is ready for test, it is best to provide terminal strip or individual "tie-point" mounting for these components.

Once the wiring is completed, all connections should be rechecked for errors and "cold-soldered" joints. Particular attention should be given to the polarity of battery connections, to transistor terminal connections, and to the color coding of transformer (T_1) leads.

Parts substitutions: The components used in assembling the author's model are specified in the parts list. A builder with a well-stocked laboratory or workshop may prefer to use parts he already has on hand where possible in order to save on "out-of-pocket" cost when assembling his own instrument.

Quite a number of substitutions are possible: the "piano-key" push-button switches (S_1 to S_{12}) may be replaced by conventional push-buttons; the toggle switches (S_{16} , S_{17} , S_{18}) may be replaced by rotary or slide switches; the 2N255 power transistor may be replaced by type 2N256; the power supply battery (B_1) may be replaced by any similar 6-volt battery of the same (or greater) capacity, or even by four standard flashlight cells connected in series. Finally, the oval PM loud-speaker specified in the parts list (and used in the model) may be replaced by

Here is a close-up over-all view of the electronic "accordion." The 12-note keyboard is at the left. At the right are the 2 loudness toggle switches and the power switch along with the 3 frequency buttons.

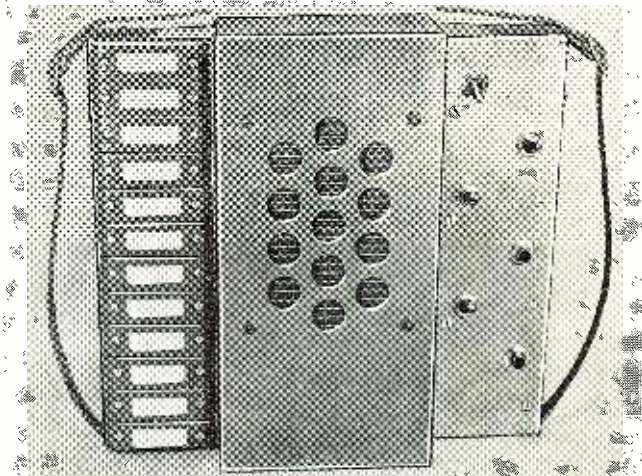

a round speaker or even two smaller round speakers connected in parallel. (Two 8-ohm speakers may be connected in parallel to provide a total impedance of 4 ohms and to match T_1 's secondary winding.)

Circuit modifications: In addition to making straight substitutions for specified parts as outlined, the individual builder may actually change the basic circuit to meet his special operating requirements, to simplify the operation of the completed instrument, or to reduce the costs and the wiring complexity.

For example, capacitors C_1 to C_3 and switches S_{13} to S_{15} may be omitted entirely if the builder does not wish the added versatility of these tone controls. Similarly, if a fixed volume level is satisfactory, R_{11} , R_{15} , S_{16} , and S_{17} may be omitted and the loud-speaker's voice coil may be connected directly to T_1 's secondary leads.

On the other hand, if the builder prefers a continuously variable "volume" control which has no effect on tone, these components (R_{14} , R_{15} , S_{16} , S_{17}) may be replaced by a fixed impedance "T" pad attenuator (such as a Mallory T2 control).

Additional (or fewer) base bias re-

sistors (R_1 to R_{12}) and corresponding switches (S_1 to S_{12}) may be used to change the operating range of the instrument. With twelve "keys," somewhat better than a single octave is covered, but the instrument itself can cover several octaves, provided enough "keys" are added. Similarly, additional (or fewer) capacitors (C_1 to C_3) may be used.

Final adjustment: Due to tolerances in the characteristics of the transistor, the transformer, and other circuit components, the final values of the base bias resistors R_1 to R_{12} (as well as capacitors C_1 to C_3) must be chosen experimentally to produce the individual musical notes desired. In general, the values for these resistors will fall between 22 and 320 ohms, depending on the range desired. For a single range of somewhat over an octave, there will be about a 2 or 3 to one variation in resistance from the "minimum" to "maximum" values. In the author's model, for example, the values range from 22 to slightly over 45 ohms.

The exact resistance value needed to sound a particular musical note is determined by connecting an adjust-

(Continued on page 141)

Rear view of the wired instrument is shown here with the back panel removed. The major components are identified and correspond to circuit on the facing page. Wiring is not critical.

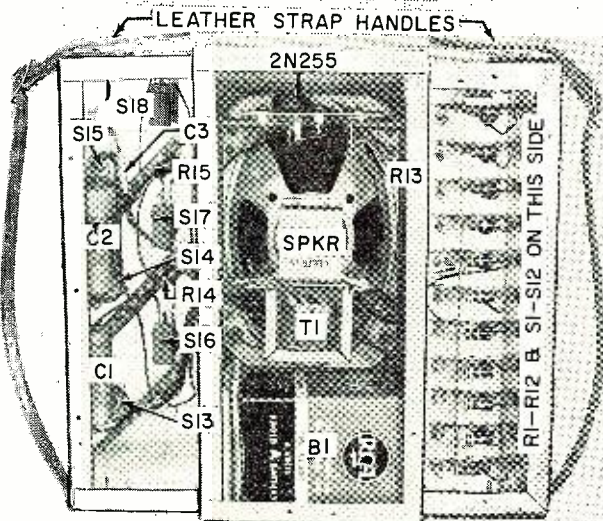

Here is a view of the power transistor mounting plate, the edge of which can be seen (with the transistor already mounted) in the view to the left. A piece of aluminum is used as heat sink.

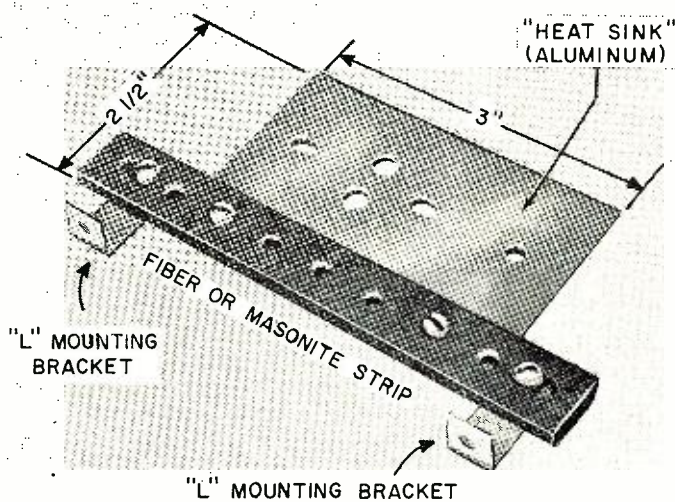

Service Business Budgets

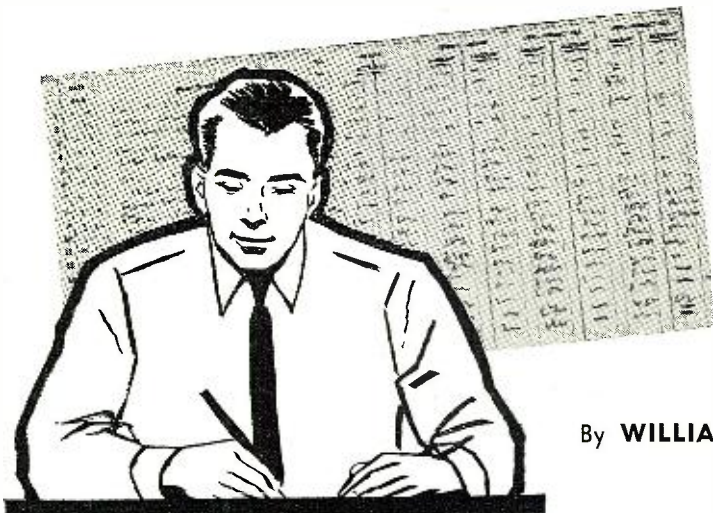

By **WILLIAM LEONARD**

Realistically planned operation can keep service dealers from spending themselves out of business.

IN THE COURSE of any year the average TV service dealer passes through at least one serious financial crisis during which he is forced to harbor doubts whether he will be able to stay in business. The annual cycles of boom and bust in TV servicing come around with such relentless regularity, it would seem that all dealers would lay aside some reserves during the fat days to tide them over the lean ones. But most dealers wear blinders when business is good and they are handling a lot of money. They overspend for stock, for equipment, and for their personal use. They dig financial holes that are hard to climb out of.

Many service dealers, under the guidance of competent accountants, have adopted the one sure plan for keeping the brakes on their spending when business is good. That plan is the use of a monthly budget based upon anticipated gross profit and set up on an annual basis. As one dealer who uses such a plan said, "Any well regulated business budgets its money. It is too easy to over-buy for stock and to take too much money out of the business for your personal use when business is good—if you do not have definite, pre-determined spending limits."

It is extremely unfortunate that TV

service dealers do not have available to them the same type of business operating statistics that have been compiled for other industries. These statistical analyses, grouped by businesses of various sizes in the activity, provide a yardstick with which the individual dealer can measure the weaknesses and strong points of his own business. As an example, a recently issued *Dun & Bradstreet* "Cost of Doing Business" Report covering the operating results in 1956 for paint and wallpaper stores provides a wealth of useful, comparative information for every dealer in that field.

TV service dealers themselves are largely responsible for the lack of similar operating information on electronic service businesses. All attempts that have been made to compile average operating figures from the combined reports of numerous individual businesses have failed because of the lack of cooperation in supplying the information on the part of dealers.

A step in the direction of gathering this extremely necessary and useful information on electronic service businesses was recently taken in Missouri. A committee made up of representatives of the manufacturers, distributors, and service dealers mailed a questionnaire to a list of 635 service dealers in that state. This question-

naire sought the opinions of dealers on how to improve relations between manufacturers, distributors, and the independent service industry. The only question relating to business operating included in this survey was the request for each dealer who answered it to include the gross annual volume of business handled by his shop.

The dealers who cooperated in this survey reported annual volumes ranging from \$200 to \$250,000. The average for the 142 dealers who completed the questionnaire was \$27,835 per year. On the basis of other available information, it is probable that this annual volume is ten thousand dollars or more above the national average of shops in the electronic service business.

There are three types of income that must be analyzed separately in a service business in determining the gross profit and its use, percentage-wise, in the operation of the business. First, of course, there is the income developed from the sale of service; second, the profits realized from the sale of tubes and parts; and third, the profits from the sale of new sets. Where the dealer has one-hundred per-cent of the income from the sale of service to use in paying his operating expenses, his average gross on tubes and parts is possibly forty per-cent. On new set sales he is fortunate if he can realize a gross profit of twenty-five per-cent.

The relationship of gross profit to gross income was discussed at some length at a recent meeting of service dealers in the Midwest. In explaining his approach to setting up an annual budget, one dealer said:

"For the sake of discussion, let's say that a service business is doing an average of three thousand dollars gross volume per month. This is an average on an annual basis. The business may do as much as five thousand dollars per month in October and November and drop to only twelve hundred dollars a month in May and June.

"Let us further assume that the three thousand dollars gross per month includes one thousand dollars from the sale of labor and time and two thousand dollars from the sale of parts, tubes, accessories, and perhaps a few new sets.

"I selected the figure of one thousand dollars per month as the income from the sale of labor because that would average out eight calls per day, six days per week at five dollars per call.

"Now let's further assume that the fixed operating expenses of this business run \$1500 per month. This includes the salary or draw of the owner. With a gross of three thousand and fixed operating expenses of \$1500, there would be \$1500 per month available, over and above operating expenses, to pay what? So let us examine the gross income closely.

"The business had one thousand
(Continued on page 143)

A Low-Cost Hi-Fi Amplifier

Over-all views of the low-cost hi-fi amplifier along with its separate power supply. The new miniature beam power tube used is shown directly below.

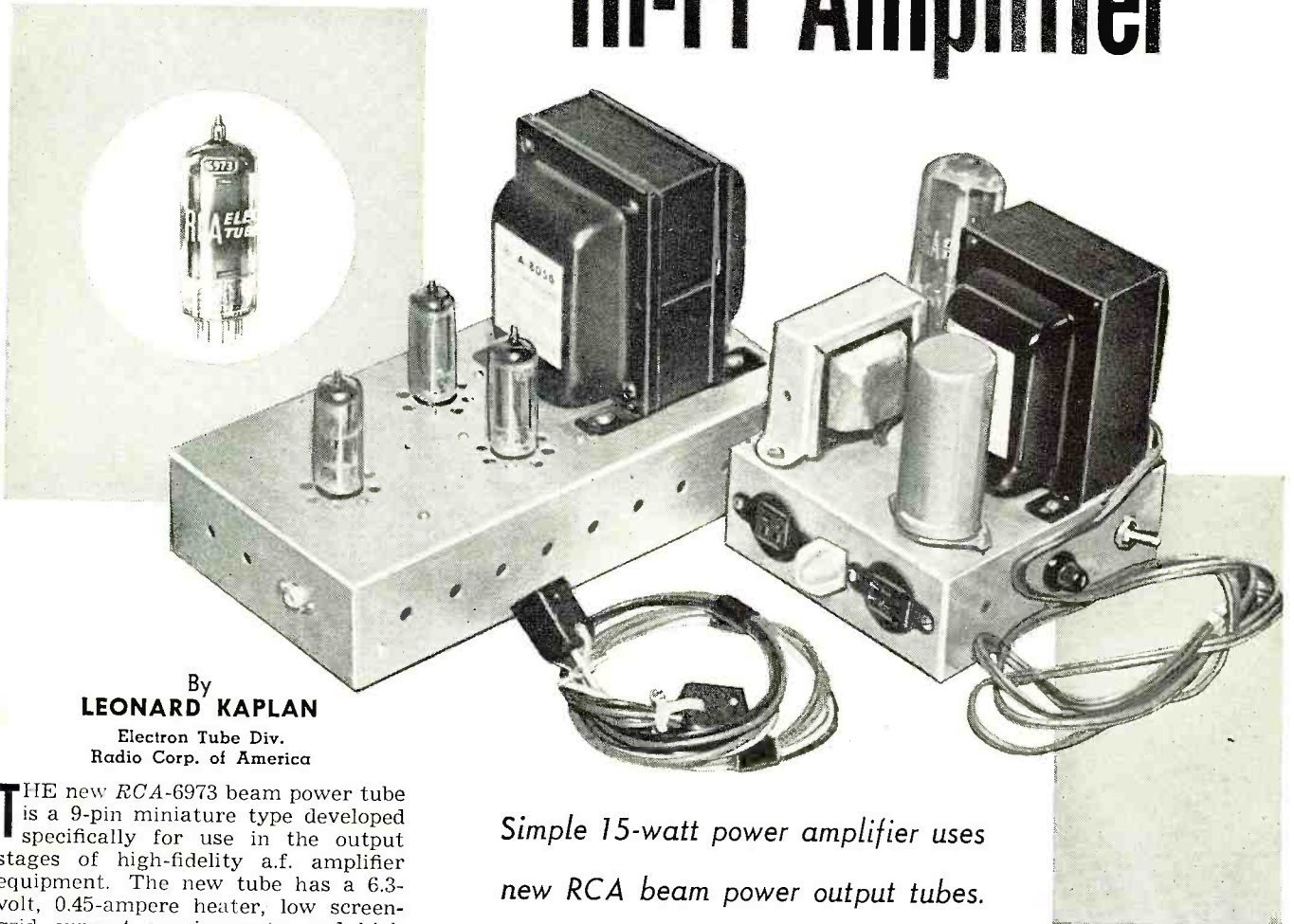

By
LEONARD KAPLAN

Electron Tube Div.
Radio Corp. of America

THE new RCA-6973 beam power tube is a 9-pin miniature type developed specifically for use in the output stages of high-fidelity a.f. amplifier equipment. The new tube has a 6.3-volt, 0.45-ampere heater, low screen-grid current requirements, and high plate and screen-grid voltage ratings which allow it to operate very efficiently in a variety of output circuits. It is provided with specially designed grid structures and a basing arrangement which assure cool grid operation and freedom from grid emission. This feature permits the use of much higher values of grid-No. 1 circuit resistance than are generally permissible for beam power tubes and gives the 6973 exceptionally high power sensitivity. Two 6973's, pentode connected, in a conventional push-pull class AB₁ output circuit can deliver as much as 24 watts of output power with very low harmonic distortion.

The characteristics of the 6973 have made it possible to design a simple, low-cost high-fidelity amplifier using only three tubes and having performance characteristics indistinguishable from those of amplifiers having much more complex circuits, using more tubes, and costing many times as much. The new amplifier employs only standard, non-critical components, and does not contain any circuits, bal-

*Simple 15-watt power amplifier uses
new RCA beam power output tubes.*

Power Output:	15 watts continuous; 19 watts for short bursts
Sensitivity:	.98 volt for 15 watts output
Frequency Response:	17 to 60,000 cps \pm 1 db
Output Impedance:	.65 ohm at 60 cps on 8-ohm tap
Total Harmonic Distortion at 1000 cps:	.17% @ 1 watt output; .19% @ 4 watts; .2% @ 8 watts; .4% @ 15 watts
Hum and Noise:	90 db below 15 watts (input shorted) 75 db below 15 watts (input open)

Table 1. The performance characteristics of the amplifier described below.

ancing adjustments, or other controls which might require the use of test equipment. Anyone with a soldering iron and a modicum of construction experience should be able to assemble the unit and duplicate the results obtained in the laboratory.

Design Consideration

The initial specifications for the amplifier were: (1) It should be capable of reproducing everything the human ear can detect and, therefore, should have a frequency response flat within \pm 1 db from 20 to 20,000 cps. (2) Total harmonic distortion at full output

should be less than 0.5% so as to be virtually undetectable to even the most discriminating listener.¹ (3) Because most authorities agree that a dynamic range of approximately 70 db is necessary for high-fidelity reproduction it should have a power output of at least 15 watts so as to be capable of reproducing a range of 75 db when used with speakers of average efficiency.^{1, 2} (4) To assure good loudspeaker damping and permit operation with any type of loudspeaker system, including the new electrostatic types, it should have the lowest possible terminal impedance and the highest

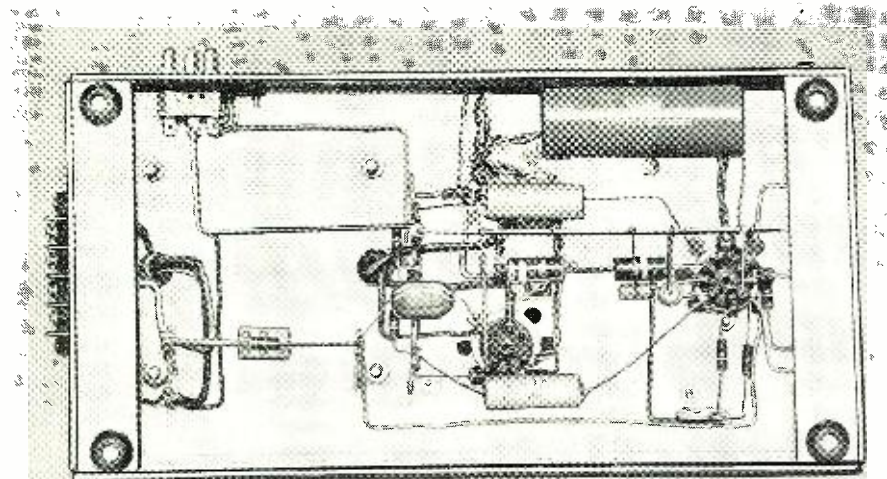

Bottom view of the amplifier itself is shown here. Note the simplicity of the wiring and the absence of any crowding. Note also the use of the ground bus.

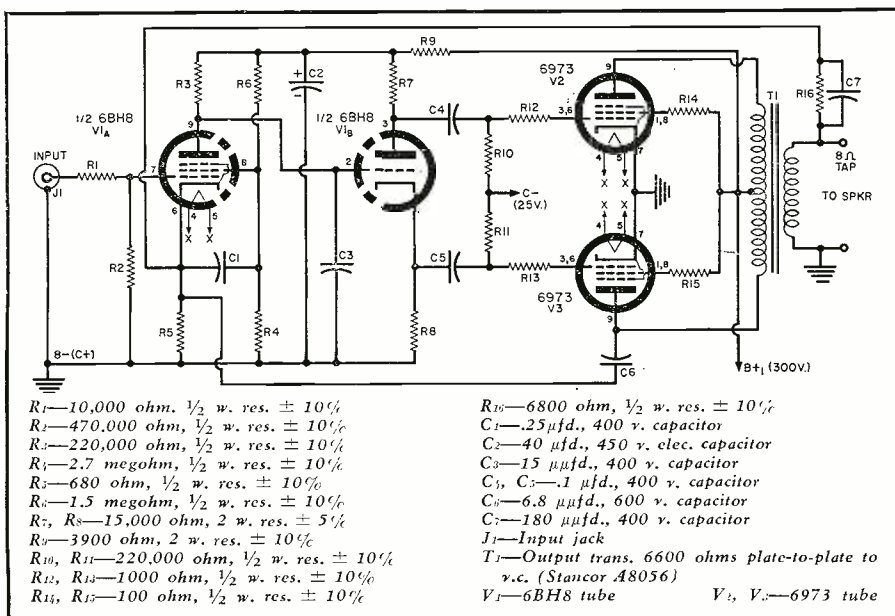
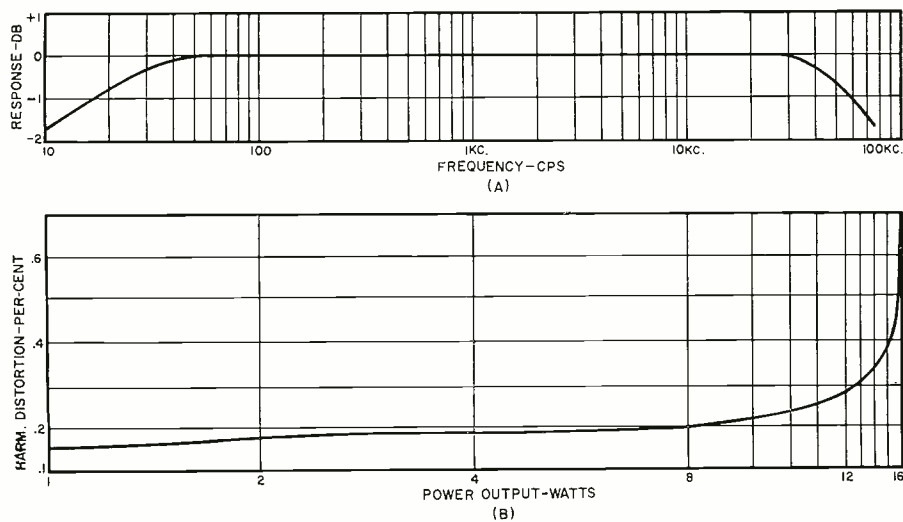

Fig. 1. Complete schematic of the low-cost amplifier. This unit is not available in kit form but must be built by the home constructor from this circuit and parts.

Fig. 2. (A) Frequency response of the power amplifier taken at a reference level of 1.25 watts output. (B) Total harmonic distortion at various output powers.



possible margin of stability. (Margin of stability is a term used to describe the ability of an amplifier to refrain from bursting into oscillation when used with a reactive load or when excited by signals having steep wavefronts.)

Circuit Design

The circuit of the amplifier is shown in Fig. 1. The amplifier employs a pentode input stage, direct-coupled to a triode split-load-type phase inverter which, in turn, drives a pair of 6973's in push-pull class AB. The 6973's are pentode connected and are operated with fixed bias. The input and phase-inverter stages use the recently introduced RCA 6BH8, which contains a high-gain pentode and a medium-mu triode in one envelope.

The use of direct coupling between the input and phase-splitter stages minimizes phase shift at low frequencies and consequently increases the amount of inverse feedback that may be used without danger of low-frequency instability. Because the plate voltage of the input stage determines the bias on the phase splitter the use of direct coupling can introduce certain difficulties, particularly in a high-gain, high-impedance circuit such as this one; that is, normal variations in the characteristics of the input pentode can produce wide variations in the operating point of the following triode. This difficulty has been substantially overcome by obtaining the screen-grid voltage for the pentode from a high-impedance voltage divider. This voltage divider serves two purposes: (1) it prevents excessive screen-grid voltage from being applied to the tube during the warm-up period; (2) the large IR drop in the 1.5 megohm resistor tends to stabilize the screen-grid voltage against the effects of changes in tube characteristics. Since the plate current and plate voltage of the pentode are highly dependent on the screen-grid voltage, the plate voltage also tends to stabilize from tube to tube so that any 6BH8 will perform well in the circuit.

One of the difficulties sometimes experienced with the split-load-type phase inverter is unequal high-frequency response in the two sections of the circuit due to the fact that the plate section has higher impedance to ground than the cathode section. This difficulty has been minimized to a large degree in the new amplifier by use of a low-value load resistance (15,000 ohms) for each of the sections. The resulting high-frequency unbalance is negligible within the audio-frequency range and is less than 2 db at 100,000 cps.

A class AB amplifier delivers highest efficiency and lowest distortion when operated with fixed bias. This method of operation has several advantages: (1) The quiescent currents are low and heavy currents are drawn only when power is being delivered to the load. Tube dissipation at normal signal

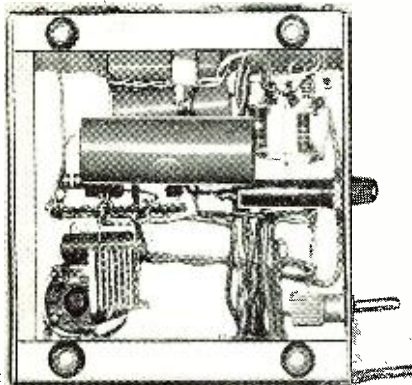

↑ Underside view of the separate power supply used with the amplifier. Selenium rectifier supplies fixed bias used.

Fig. 3. Diagram and parts list for separate power supply unit. A 6.3-volt pilot lamp may be wired to points "XX."

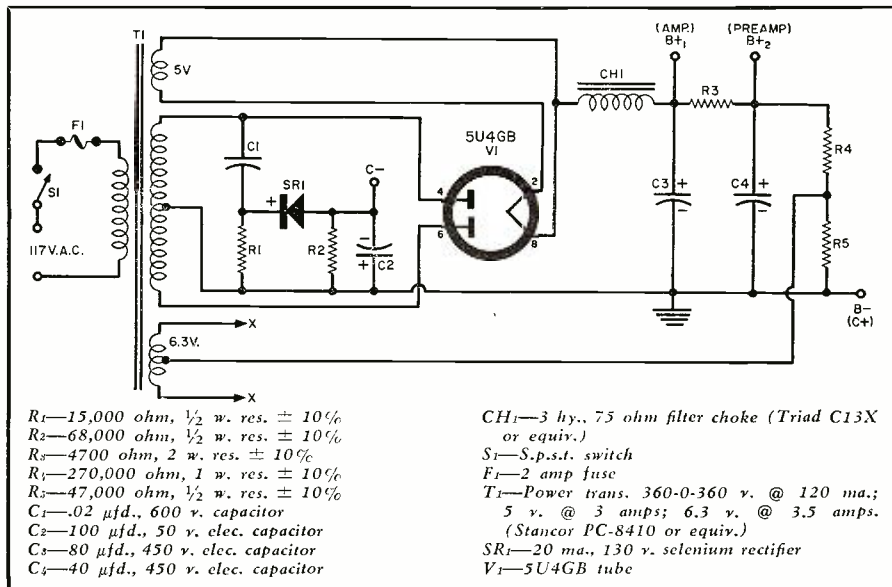

levels is very small and, therefore, is favorable for long tube life. (2) The reactance of the cathode bypass capacitor normally used in a self-biased stage is eliminated. Practical sizes of cathode-bypass capacitors seldom provide adequate bypassing at very low audio frequencies. Their reactance increases rapidly as the frequency is lowered and causes a corresponding increase in output impedance which is detrimental to the stability of the amplifier when large amounts of feedback are employed. (3) The elimination of the self-bias resistor allows the bias to be independent of signal level and allows optimization of bias for lowest distortion.

Negative voltage feedback of 19.5 db is applied around the entire amplifier to assure very low output impedance and minimize distortion. The small capacitors connected from the grid of the 6BH8 triode to ground and from the plate of one output tube (the lower one on the schematic) to the cathode of the input pentode increase the margin of stability substantially, as a glance at the photographs of the square-wave response in Fig. 4 will show.

Power Supply

Fixed-bias operation of the output stage requires that the plate supply have very good voltage regulation because the plate current varies considerably with the signal level. The circuit of the power supply is shown in Fig. 3. It is a conventional choke-input system, and provides excellent regulation at low cost. The fixed bias voltage for the output stage is obtained from one-half of the high-voltage winding of the power transformer through a capacitance-resistance voltage divider and a 20-ma. selenium rectifier. The voltage divider allows the use of a selenium rectifier having a rating of only 130 volts r.m.s. The center tap of the heater-supply winding is connected to a resistive voltage divider across the output of the power-supply. The resulting 50-

volt positive heater bias minimizes heater-cathode leakage and eliminates the need for hum-balancing adjustments.

Conclusion

The extent to which the original objectives have been achieved may be seen from the performance data shown in Figs. 2 and 4 and in Table 1. It can be seen that in every respect the amplifier exceeds the original specifications.

REFERENCES

1. Langford-Smith, F., ed.: "RCA Radiotron Designer's Handbook," Chapters 13, 14, 21
2. Olson, H. F.: "Elements of Acoustical Engineering," D. Van Nostrand Co., First Edition, 1947, pgs. 483-487
3. Schade, O. H.: "Beam Power Tubes," Proceedings of the IRE, February 1938
4. Williamson, D. T. N.: "Design of a High-Quality Amplifier," Wireless World, April-May 1947 and August 1949
5. Heacock, D. P. & Wissolik, R. A.: "Low-Noise Miniature Pentode for Audio-Amplifier Service," Tele-Tech, February, 1951

-30-

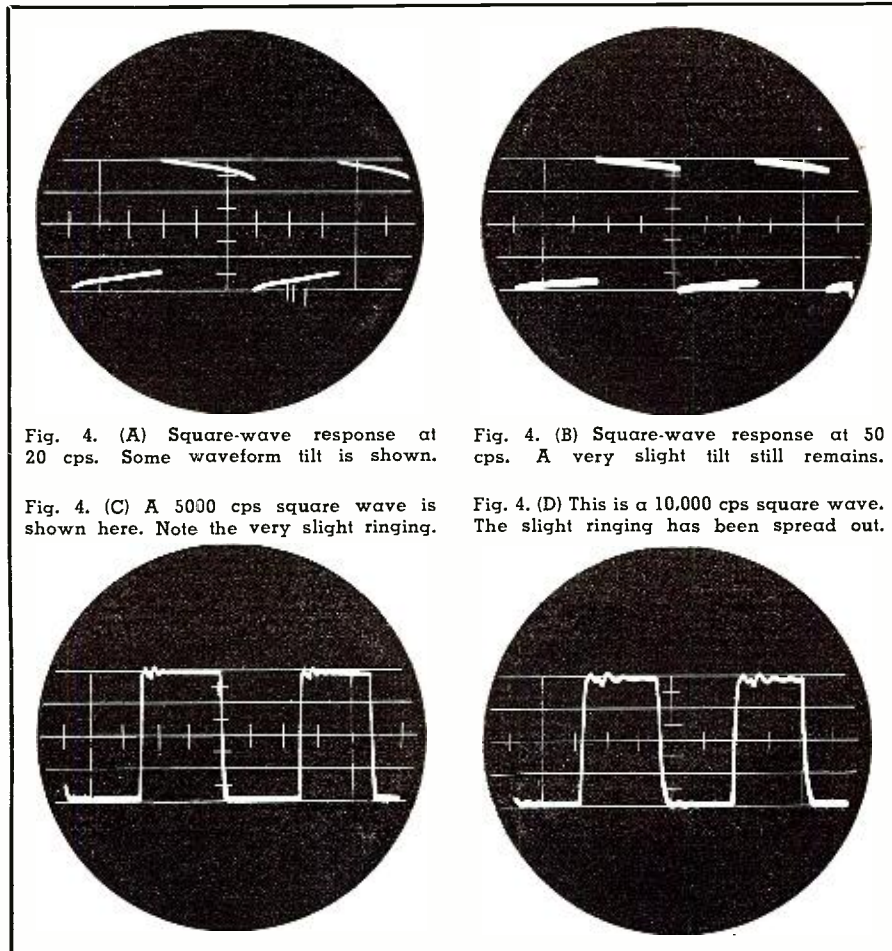

Fig. 4. (A) Square-wave response at 20 cps. Some waveform tilt is shown.

Fig. 4. (B) Square-wave response at 50 cps. A very slight tilt still remains.

Fig. 4. (C) A 5000 cps square wave is shown here. Note the very slight ringing.

Fig. 4. (D) This is a 10,000 cps square wave. The slight ringing has been spread out.

THE author's shop is often host, for a day, to a couple of students of electronics. These individuals, who entertain the ambition of some day joining the profession, have become partners in an amicable arrangement: in return for the time spent in explaining what we do to sets under repair—and why—they do such things as making routine checks of tubes and cleaning up chassis. This arrangement provides another benefit. It gives the bench men an appreciative audience and a chance to talk shop. A running commentary of what goes on during a typical day will give you an idea:

There are three sets awaiting service and one more due in later in the day. Each of the chassis bears a brief note on the job sheet containing any information the outside technicians think may help the bench man. We insist on factual information, *not* an attempt at diagnosis. An exception is the case where the outside man knows for sure what the trouble is but, for some reason, was unable to fix it in the home. Sometimes the notes are so detailed that an immediate lead is given; sometimes the information is no more helpful than, "Mrs. Johnson says the picture is still too far back!"

The job sheet on the first one says "Touchy horizontal hold—phase coil adjustment very critical." The tubes have already been checked, so we can get to work on the set, an *Emerson*, right away. Fired up and connected to the antenna, the set shows a good picture, but just a touch one way or the other on the horizontal-hold control will throw the picture out of sync. The slightest movement of the slug in the phasing coil moves the picture across the screen and half a turn either way will also throw the picture out.

"What do you think that is?" asks Jack. "Missing sync pulse, I guess," answers the bench man, and reaches for the scope low-capacity probe. However, on attaching the probe to the input grid of the Synchroguide stage (see Fig. 1), there is displayed on the scope a perfect waveform with a good high sync pulse sitting snugly up on the saw-tooth. More as a matter of habit than anything else, he transfers the probe to the junction of the phasing coil and oscillator coil and glumly surveys another perfect waveform. This one is the familiar "sine-wave-plus-spike" which is said to be engraved on the heart of every technician after a lifetime of fighting mode-hopping (or squegging, if that's your local term) oscillators.

"According to the scope, the set should work fine," says the bench man. "Now we'll have a look at the grid with a v.t.v.m. and check for bias variation."

He attaches the d.c. probe of the v.t.v.m., sets the pointer at center-zero, and slowly turns the horizontal-hold control while watching the pointer: "See that voltage on the grid?"

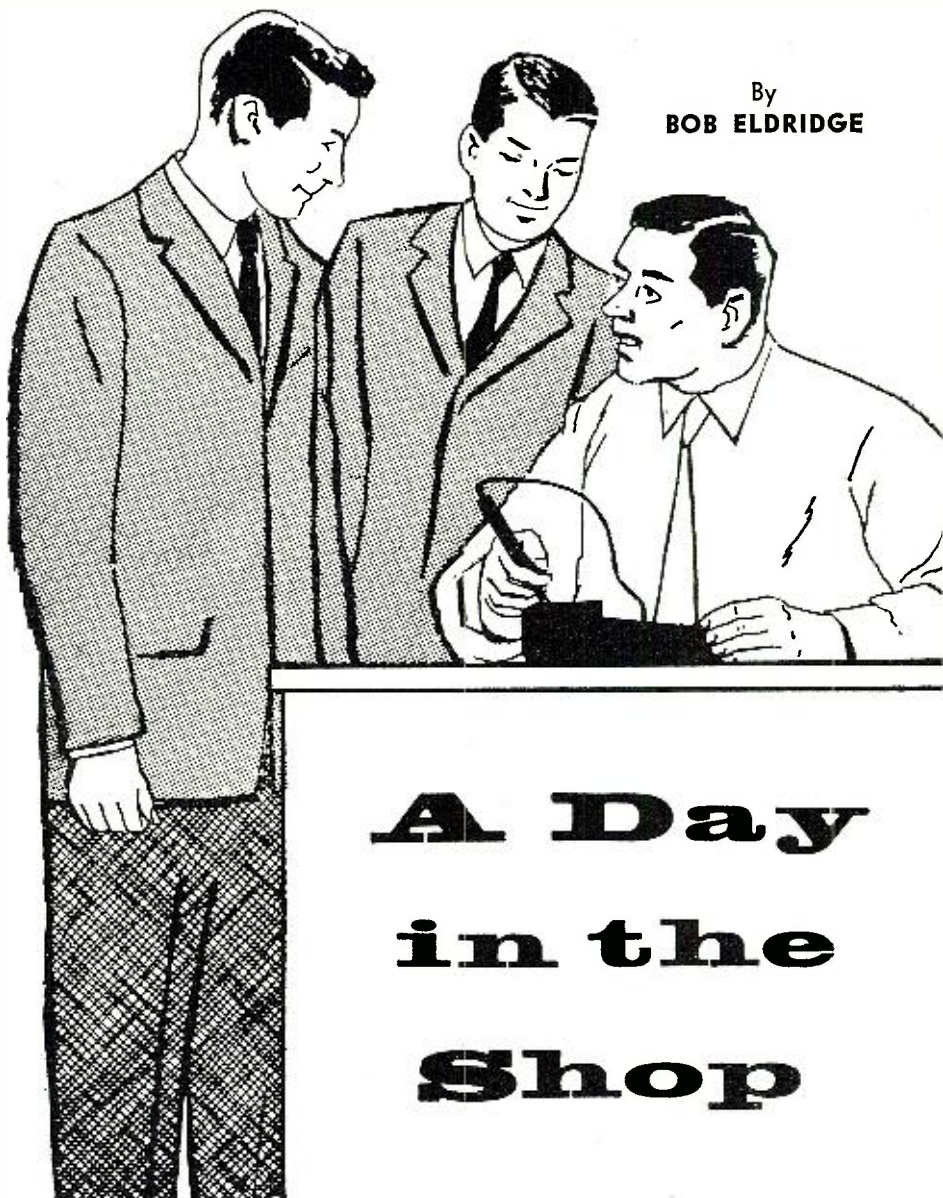

By
BOB ELDRIDGE

A Day in the Shop

Wisdom from an experienced bench man illuminates practical problems for two electronics students.

That should vary smoothly in either direction, depending on which way I turn the hold control. As I try to increase the frequency of the oscillator by turning the control, the voltage should change on the grid to maintain oscillator speed at 15,750 cps. As you see, the voltage doesn't change much until suddenly it jumps up as the picture goes out of lock. This is our first clue. Now we must check to see whether there is a leak to ground from the grid, which would short the correction voltage."

He turns the set off, waits a minute or so for the heaters to cool, and then measures from grid to ground with the ohmmeter. He finds over 1 megohm, which is normal and explains "I had to let the tube cool off, otherwise the small positive voltage on the ohmmeter probe might cause conduction between cathode and grid of the tube and give me a false reading." He then

checks each of the resistors in the grid and cathode circuits of the control section to the left. (A glance at Fig. 1 will show that there are no parallel paths here, so provided that none of the capacitors have leakage, it is not necessary to disconnect any of the resistors to measure them.)

Each of the capacitors is then disconnected at one end and tested on a checker for capacitance and leakage. The .047 and the .022 check normal but the .47 shows definite leakage at 250 volts and up. "This capacitor is rated at 150 volts," says the bench man, "but we can't take chances in a Synchroguide circuit. Let's replace this one before going any further. If we are lucky, this may be the trouble anyway." Sure enough, when the capacitors are reconnected and the new .47- μ f. unit is in place, the set reacts in a perfectly normal manner. After setting up the oscillator and

checking on the scope for correct waveform (spike slightly higher than the hump) all that remains is to check the sound adjustments, a routine in the shop, and check operation on each of the channels available. The set is put aside on the running-up bench for a test run before being finally put aside for delivery to the customer.

Multivibrator Woes

The next set in line also has horizontal troubles—no raster at all in fact—and the note says “No high voltage, but oscillator working.” A quick check with the v.t.v.m. at the grid of the 6BQ6 shows some negative voltage, but only about 10 volts, whereas normal on this set is about 25. Cathode voltage is plus 13 volts (normal across the 100-ohm cathode resistor is about 10 volts, indicating 100 milliamperes normal current through the tube). Screen voltage is about normal at 160 volts.

“What does that tell you?” asks Jack. “Well, first the oscillator is working, producing some grid drive to the output tube and, second, the output tube is passing a bit too much current—but almost any fault in the output stage has something of that same effect. Let’s look at the boost voltage.”

He checks the width coil, using the 1500-volt range of the v.t.v.m. but finds just the same 300 volts that exists on the “B+” line, so there is no boost. “Well,” says the bench man, “on this set that usually means a short in the yoke or in the width coil or in the flyback or—most likely of all—a shorted .1- μ fd. boost filter capacitor. Let’s clip on the substitution box in place of the .1- μ fd. capacitor.”

“This set makes a louder squeal than usual, doesn’t it?” asks John, the second student. “Hey! That’s a point,” says the bench man, “it’s not only louder, but it’s *lower!* That’s only 5000 or 6000 cycles. Let’s think about that a bit. There’s a fault that happens on the G-E ‘J’ chassis that causes just that kind of effect when the 20- μ fd. filter in the oscillator ‘B+’ supply goes open.”

He takes the substitute electrolytic from under the bench, clips the negative wire to the chassis, the positive end to the “B+” side of the ringing coil (Fig. 2) and bingo! Up comes the raster. “Let’s go and have coffee on that one!”

While in the coffee shop for a 15-minute break, the bench man explains that, when the filter capacitor in the plate “B+” supply is good, the cold end of the ringing coil is effectively grounded as far as the r.f. is concerned. However, when the filter goes open, the grounded point becomes “hot” to r.f. The plate impedance of the oscillator is effectively raised so much that it cannot operate at the correct frequency. Thus the oscillator is working and is driving the output stage, but *not* at 15,750 cps.

“I remember,” he muses, “the first time I came across that fault. Charlie

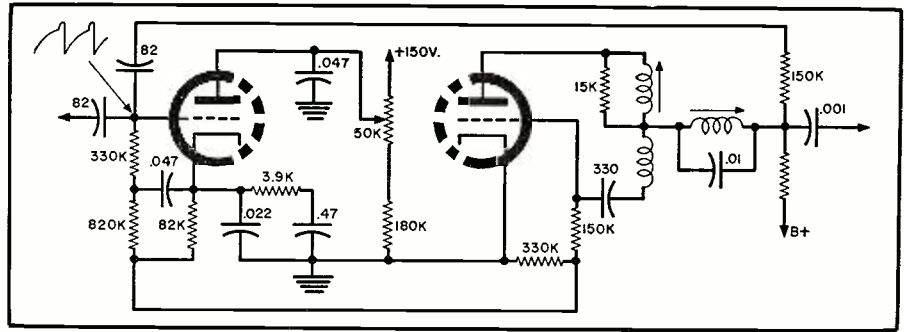

Fig. 1. Pulse-width (Synchroguide) horizontal oscillator with a.f.c. triode.

was working on an old *Stewart-Warner* that had no raster and it was emitting such a whistle that, even with the speaker disconnected, the audio-output transformer was sending out enough noise to irritate everyone in the shop. We all asked Chuck at least to stop the whistle before he went on with the job, but he didn't bother to do so—maybe he has a built-in filter in his ear. Anyway, when he slipped out for lunch without having got the set going, we had a quick look at the job. We found the noise was due to modulation at the screen of the 6A5 audio tube, so we hooked in a 40- μ fd. capacitor to remove the modulation. To our surprise the raster fired up and the set worked like a charm. We wired in the capacitor, professional-like, and switched the set off.

“When Chuck came back from lunch and switched it on, he erupted so violently the air almost turned blue around him: ‘The blankety-blank set has started up on its own now!’ We soothed him by explaining what had happened. Sure enough, when he checked into the set, he found the 80- μ fd. filter in the power supply was open, causing exactly the same effect we had in the set there on our bench except that, in his case of course, the screen of the audio tube came off the same ‘B+’ point. I remember so vividly ‘the Case of Chuck and the *Stewart-Warner*’ that I feel ashamed of myself for not noticing the symptoms on this set more quickly. The coffee’s on me.”

Back in the shop, the bench man wires in a 10- μ fd. capacitor in place of the defective 10- μ fd. section shown in Fig. 2, makes a careful check of the

rest of the set, adjusts the sound, and the chassis joins the *Emerson* over on the running-up bench.

Another Missing Raster

The next one up, a 1953 *Admiral* with somewhat similar circuitry to Fig. 2, also has no raster and has nothing helpful on the job sheet at all. The plate resistor of the first section of the oscillator has obviously been overheated, which usually means there is positive bias on the grid. The bench man withdraws the 6BQ6 before switching on the set—there is no point in over-running the output tube while the oscillator is being investigated. Attaching the d.c. probe of the v.t.v.m. to the grid of the 6SN7, he switches on the set—and overswings the needle past the 100-volt mark before the tubes have even warmed up.

“There’s a definite clue,” says the bench man, “where do you think that voltage comes from?” Both students look at the circuit diagram on the bench. “One of those .001- μ fd. units from the separator shorted?” asks Jack. “Look more carefully and you can see *which* one,” says the bench man. “Oh, yes,” says Jack, “the one from the plate circuit because the cathode has no voltage until the tube starts to conduct.” “Dead right,” approves the bench man. “If the voltage only appears after the tubes have warmed up, it may be the capacitor coming from the cathode of the sync separator or it may be due to a short in the 6AL5 phase discriminator. Sometimes if that .01- μ fd. capacitor at the 6AL5 cathode goes open, you get a thumping big spike coming in from

(Continued on page 134)

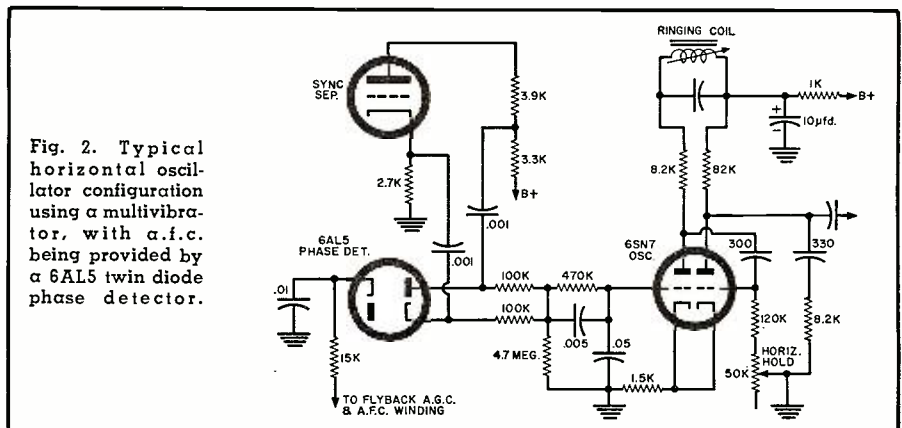

Fig. 2. Typical horizontal oscillator configuration using a multivibrator, with a.f.c. being provided by a 6AL5 twin diode phase detector.

How The G-Y Signal is Used



By **ROBERT G. MIDDLETON**
Radio Electronic Television Schools

R-Y, G-Y, B-Y, I, Q—has the "alphabet soup" of color-TV terminology been causing you confusion? Here is a readable clarification of key points.

IF YOU have started to service color-TV receivers, and even if you haven't, you know that many of the present-day chassis are using *G-Y* chrominance detectors. The basic difference between the newest receivers and the earlier ones is shown in Fig. 1. The configuration of Fig. 1A is called *R-Y/B-Y* detection and represents a slightly older design practice. The arrangement of Fig. 1B is called *R-Y/G-Y* detection which is now becoming more popular.

The chief advantage in using the *R-Y/G-Y* detection system is realization of improved signal-to-noise ratio or improved weak-signal reception. This improvement is possible because the *G-Y* signal is transmitted at a higher level than the *B-Y* signal.

At this point many of you are saying: "Now wait just a minute—we know very well that color-TV signals are transmitted along the *I* and *Q* axes; so how can you talk about transmitting a *G-Y* signal?"

This is quite true—as far as it goes. And there is the point: the simple statement that transmission is made along the *I* and *Q* axes does not go far enough. There is considerably more

to a color-TV signal than meets the eye (at least at first sight!).

Let us consider for a moment what *I* and *Q* mean. These are initials which signify "in phase" and "quadrature phase." Why should these particular designations be used? They are used principally because it is easier and quicker to speak of a transmission primary as the "*I* phase," rather than as the "orange-cyan axis." Likewise, it is easier to speak of the "*Q* phase" rather than the "green-magenta" axis.

If you inspect the reproduction of a color-bar signal on the screen of a color-TV receiver (see Fig. 3) you will observe indeed that the *I* signal produces an orange or a cyan hue, depending upon whether it is positive or negative. Likewise, the *Q* signal produces a green or magenta hue, depending upon whether it is positive or negative. (You may argue that the hue is slightly off-green or off-magenta, but this is beside the point.)

But why *I* and *Q*, rather than some other letters? Just what do we mean by "in phase" and "quadrature phase"? The answer to this question lies in the fact that color-TV transmission originally was made along the *R-Y*

and *B-Y* axes. The *B-Y* (blue minus luminance) axis is in phase with the 3.58-mc. subcarrier burst and the *R-Y* (red minus luminance) axis is in quadrature phase with this burst, as we see in Fig. 2.

Now, it was found that the best color characteristics could be transmitted by shifting the transmission axes 33 degrees from their *R-Y* and *B-Y* positions, as depicted in Fig. 4. These axes are no longer in phase with anything in particular, except perhaps subjective human reaction to color. But we need a shorthand designation for them, and it was convenient to dub these axes *I* and *Q*. And there you are.

When transmission axes were changed to *I* and *Q*, it became possible to use wide-band transmission along the *I* axis for high-fidelity color reproduction (optimum chroma-circuit response). This shift of transmission axes, however, had no effect whatsoever upon the proportions of *R-Y* and *B-Y* contained in red, or green, or any other color because these proportions remain fixed. This fact is illustrated in Fig. 6, which shows that the red chrominance signal "stays the same" whether transmitted by *I* and *Q* components or by *R-Y* and *B-Y* components.

It then follows that a red signal, although transmitted along the *I* and *Q* axes, can be demodulated along the *R-Y* and *B-Y* axes at the receiver. To take another step, how about the *G-Y* axis shown in broken lines in Fig. 2? A red signal, for example, also exists with respect to the *G-Y* axis, as depicted (*O-C*) in Fig. 8. Likewise, a green signal has a component (*O-F*) along the *G-Y* axis, as seen in Fig. 5.

Since it is thus quite possible to demodulate a chrominance signal along *R-Y* and *G-Y* axes, instead of *R-Y* and *B-Y* axes, we may ask "What advantage can be gained by *R-Y/G-Y* demodulation?" The advantage comes about principally from the fact that

chrominance values are re-adjusted prior to transmission, to avoid over-modulation of the transmitter. Compare Figs. 7A (before re-adjustment) and 7B. In the re-adjustment process, *R-Y* is reduced to .877 of its original value. *B-Y* is reduced to .493 of its original value. But, in this process, *G-Y* is increased to 1.423 of its original value.

Of course, these values must be re-

stored finally at the receiver, by suitable adjustments of gain in the three chrominance channels, but this is no problem. In any case, the incoming chrominance signal contains *G-Y* at a level much in excess of *B-Y*. That is, the *G-Y* signal is better able to compete with noise than is the *B-Y* signal. Hence, dictates of good receiver design, other things being equal, call for the use of *R-Y/G-Y* detection

rather than *R-Y/B-Y* detection. After *R-Y* and *G-Y* signals have been recovered in the synchronous detectors, it is a simple matter to matrix these signals to obtain a relatively noise-free *B-Y* signal.

The question may well be asked: "Why do all modern color receivers use *R-Y*, *B-Y*, and *G-Y* channels in one arrangement or another? Why not (Continued on page 149)"

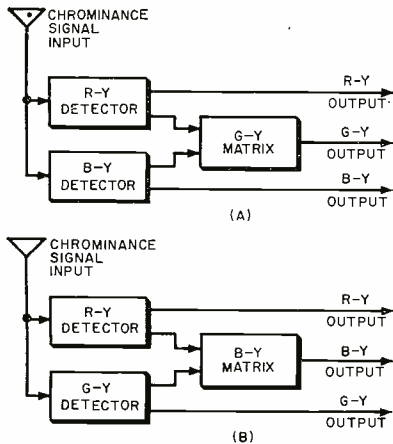

Fig. 1. A receiver chrominance channel set up (A) for *R-Y/B-Y* detection and another (B) set up for *R-Y/G-Y* detection.

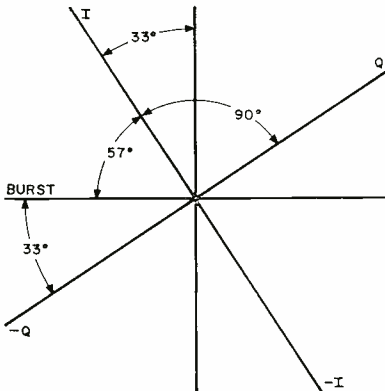

Fig. 4. The phase relationship between the arbitrary *I* and *Q* axes and the 3.58-mc. burst, which coincides with *-B-Y*.

Fig. 7. The normal levels (A) for the various chrominance components of standard colors are re-adjusted (B) prior to transmission in actual practice.

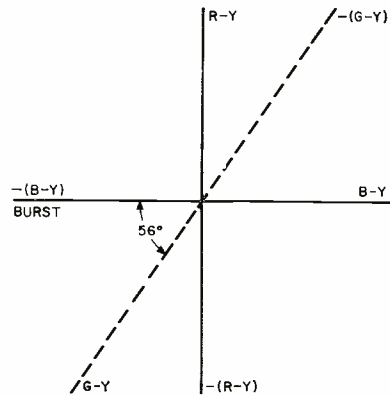
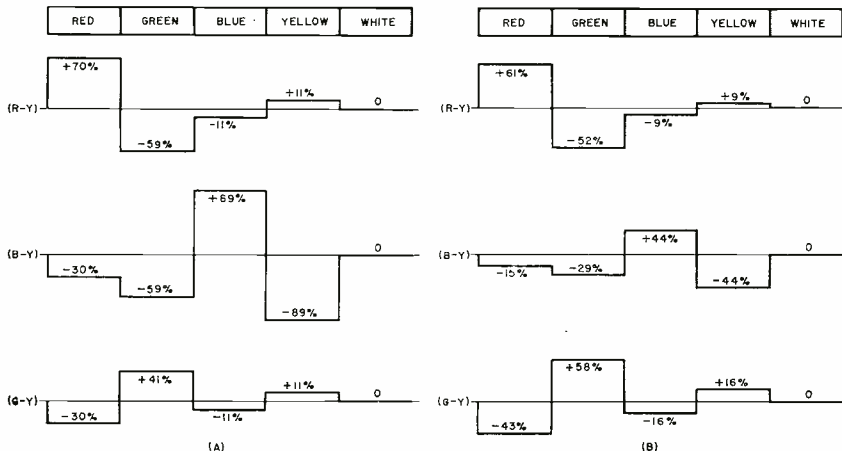

Fig. 2. The *B-Y* axis is "in phase" with 3.53-mc. burst, but "in quadrature phase" with the *R-Y* axis; i.e., 90 degrees away.

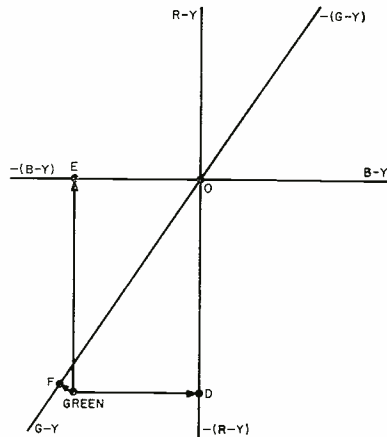

Fig. 5. Location of a fixed green signal with respect to *R-Y* (line *O-D*), *G-Y* (line *O-F*), and *B-Y* (line *O-E*) axes.

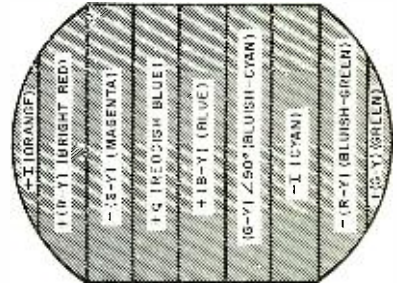

Fig. 3. Standard color-bar pattern.

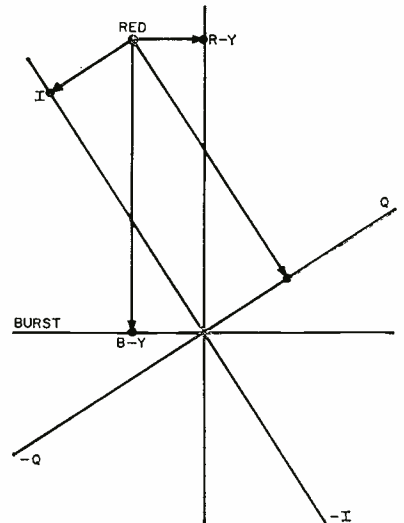
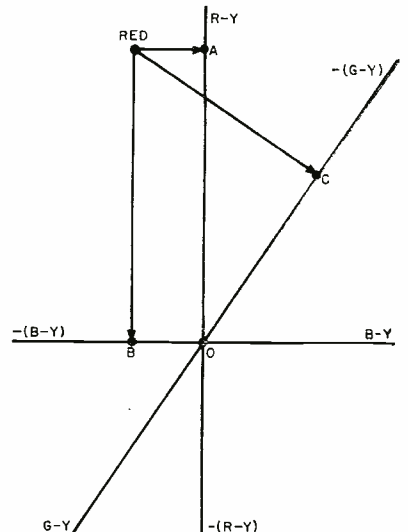
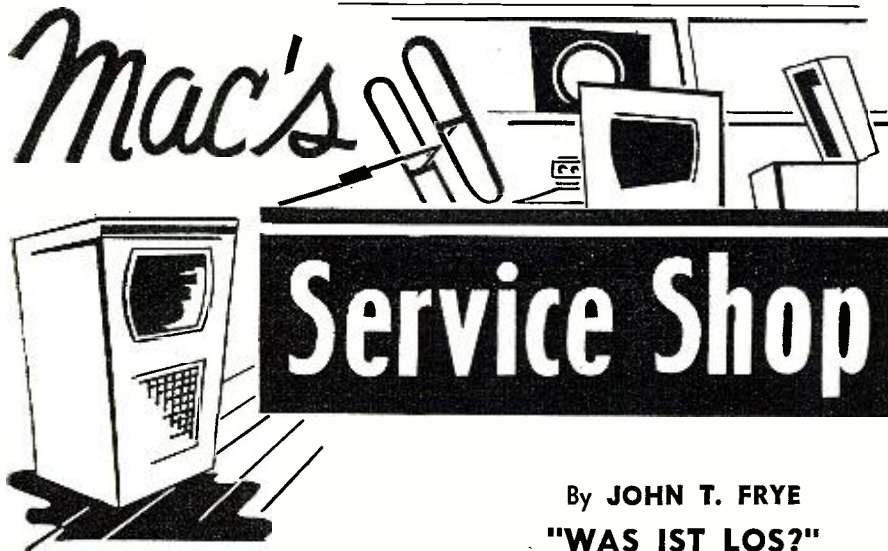

Fig. 6. Any color signal (such as red) "stays in the same place" regardless of which axes are used for transmission.

Fig. 8. A red signal as it exists with reference to *R-Y* and *G-Y* axes.





By JOHN T. FRYE
"WAS IST LOS?"

SPRING had been a long time coming, but finally made it. A warm breeze was wafting in the wide-open door of Mac's Service Shop this sunny morning and shortly after eight o'clock Barney himself wafted through that door. His blue eyes had a dreamy, far-away look in them that promised little in the solder-slinging line for this day.

Mac, the owner of the shop, was already at work at the bench. A large cream-colored, gold-trimmed portable was in front of him and he was frowning at a small crumpled diagram spread out on the bench. At his elbow was a German-English dictionary.

"Hey," Barney exclaimed as his eyes focused on the receiver; "what you got there? That's a pretty gaudy portable, isn't it?"

"Yep," Mac said without looking up. "It's a Metz 'Babyphon' 56 receiver made in Germany. An Air Force fellow stationed in England bought it there and had it shipped home. It has some pretty unusual features."

"Looks as though it might have," Barney agreed. "Do those two little folding doors in front cover the speaker grille? And what does that 'Babyphon' name mean?"

"The speaker grille is in the end," Mac pointed out as he placed the receiver on its back; "but take a look in here," he suggested as he lifted the outside edge of the right-hand door. Inside was a turntable and a little ivory-colored pickup arm.

"Well I'll be!" Barney exclaimed. "A combination two-way portable and a baby phono player! Does that thing really work?"

"It certainly does. It plays any 45 rpm record. The motor is d.c. and this rheostat adjusts the speed. The pickup has a genuine sapphire needle. When the set is plugged into the 'mains' as the instruction book has it, power for the motor is furnished by rectified a.c. from a transformer. When you must operate the set away from the power lines, the tiny motor is run by four medium-sized flashlight

batteries connected in series. The instruction book says one set of these batteries will play eight hundred sides."

Barney had the back off the receiver by this time and was peering inside.

"What's that little square doohickey back in the corner?" he asked.

"That's a built-in, gas-tight, lifetime, nickel-cadmium storage battery that never requires any servicing except recharging. It has a rating of 1.2 volts and 3.5 ampere-hours and heats the filaments of the eight tubes that are connected in parallel. Not only does this save dry cells, but floating the battery across the filament supply when the set is operating on a.c. keeps down ripple and holds the filament voltage constant. That prolongs the life of the tubes. The battery is charging at a reduced rate when the set is operating on a.c. and you can charge the battery more rapidly with the set turned off if you like. A full charge will keep the set going for fifteen hours. On top of that, if the battery becomes discharged away from the power lines, you can just slip a standard flashlight cell into this space in the battery holder and run the filaments off it until you have a chance to recharge the battery."

"They've thought of everything," Barney remarked. "I see the 'B' battery is a standard 90-volt unit. What do all those five piano-key push-buttons do?"

"One turns the set off; one turns on the phono player; and each of the three remaining ones turns the set on and selects a different band. The long-wave band tunes from 150 to 350 kilocycles; the medium band, from 510 to 1640 kilocycles; and the short-wave band from 6 to 15.5 megacycles. When the phono button is pushed, all r.f. and i.f. tubes have their filament voltage cut off. A jack in the back enables you to run the output of the phono player into an external amplifier. When you plug into this jack, all filaments are automatically turned off and power is furnished just to the

phono motor. The boys who designed this didn't intend to waste a single electron!"

"Well, let's hear it play."

"That's the joker; get a load of this."

Mac pushed the medium-band key and the set broke into a loud motor-boating. Manipulating the bass or treble tone controls or the volume control would change the frequency of the plopping sound, but no setting of any of them would stop it entirely.

"Since when did motorboating become a tough service problem?" Barney scoffed. "Chances are the set has an open output filter capacitor."

"Chances are it hasn't; I tried that," Mac said with a grin.

"Open grid in one of the stages?" Barney offered hopefully.

"Nope; neither can I find any open bypass capacitors, loose shields, or resistors with radically changed values. I decided to quit guessing and study the diagram a bit; but I ran into a headache there, too. This diagram is in German."

"Gwan!" Barney hooted. "Quit trying to pull my leg. A diagram is a diagram in any language."

"Is that so?" Mac retorted. "Suppose you take a good long gander at this little diagram that came with the set and explain some things to me."

"Son-of-a-gun," Barney exclaimed; "it *does* look kind of funny. Do you have it figured out yet?"

"Not all of it, but I've discovered a few things. This is the power transformer here. The thick dark lines indicate transformer windings and the light line between them stands for the core. These little rectangles are resistors. The plain ones are $\frac{1}{2}$ watt. If lines bisect the rectangle both lengthways and across, the resistor is $\frac{1}{4}$ watt. Two dots inside the rectangle mean the resistor is $\frac{1}{10}$ to $\frac{1}{20}$ watt.

"Capacitors are shown by the usual symbol of two small rectangles side by side representing the two plates. In a polarized capacitor, the negative connection is shown by a blocked-in rectangle, while the positive one is left unshaded. Paper bypasses have both rectangles blocked in. Such a symbol by itself indicates a unit with a working voltage of 125 volts. A dot beside the symbol means 250 working volts. Notice this capacitor in series with the resistor from plate to plate of the push-pull output stage has a little tilde beside it. I'm not sure, but I think that means a special capacitor for use across a high-potential alternating source.

"The capacity values beside the capacitors on the diagram bothered me for a while, but I think I have them figured out. The letter 'u' means microfarads. The letter 'p' apparently means picofarads. The letter 'n' must mean 'thousands of micromicrofarads.' At least a capacitor that is marked .047 is shown on the diagram as '47n.'"

"What's this thing that looks like a
(Continued on page 132)

NEW TV Front End DESIGNS

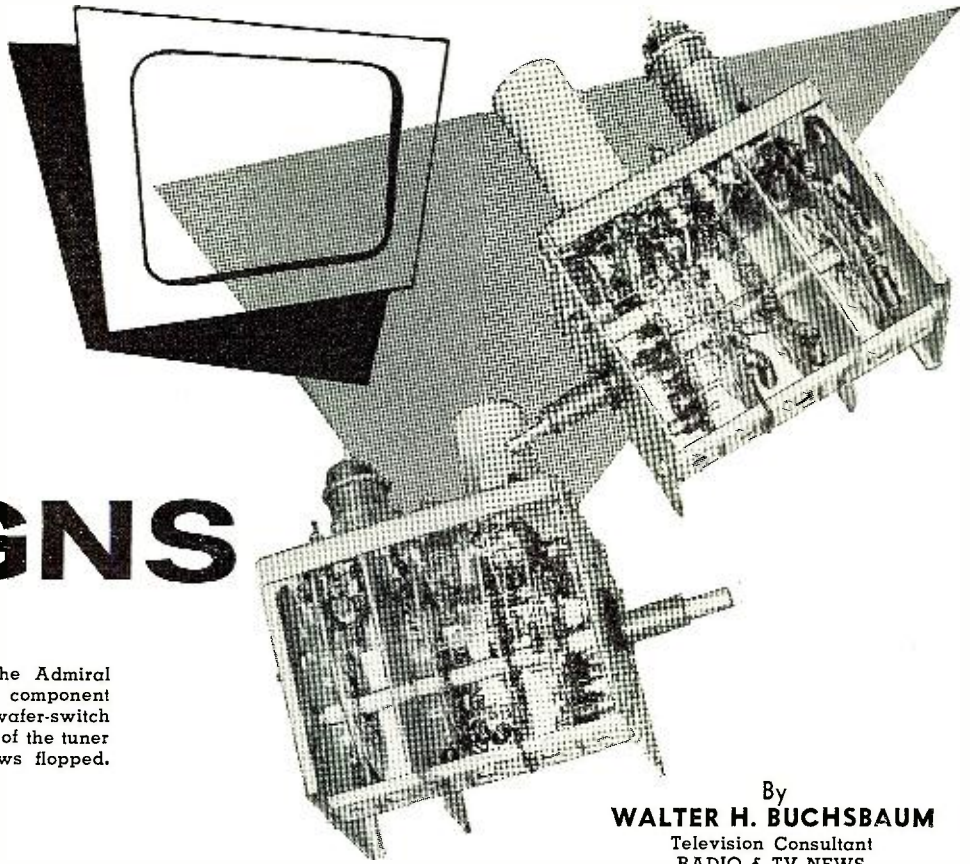

Figs. 1 & 2. Two views of the Admiral Model 94D128-1 TV tuner. This component is typical of the latest crop of wafer-switch TV tuner assemblies. Both sides of the tuner are shown here, with the views flopped.

By
WALTER H. BUCHSBAUM
Television Consultant
RADIO & TV NEWS

AN OBSERVER focusing his attention on the tuners used in today's TV receivers might react with surprise on noting that they differ considerably from those current a few years ago. Since there have been relatively few changes in tuner design during recent years, and none of them has, by itself, represented a dramatic advance, the surprise would be justified. Yet the sum total of change has resulted in tuners that are noticeably different, featuring better performance and also affecting troubleshooting and service requirements.

New, improved tubes have been developed with increased gain, lower noise figures, and more rugged construction. Because the growth of u.h.f. has not been rapid, there have been few advances in this range and most manufacturers continue to provide an optional auxiliary type of tuner that works in conjunction with a conventional v.h.f. circuit, rather than making available full 82-channel tuners or independent u.h.f.-only types. Although newer u.h.f. amplifier tubes have been developed, it would increase tuner cost to use them. Apparently the limited u.h.f. market does not warrant a concentration on improved design. Accordingly, most u.h.f. tuners incorporate only an oscillator and mixer crystal, feeding into the v.h.f. tuner and relying on the latter for gain and noise characteristics.

Basic v.h.f. circuitry still embraces the pentode r.f. amplifier, the resurrected Neutrode and the well known, low-noise-figure, cascode circuit. Oscillator-mixer tubes are now frequently

There are changing trends in preferred types, size, mechanical arrangement, and circuitry.

a combination pentode and triode. The latest TV tuners have a number of features not previously found together, but the increased gain and better noise figure have also made the entire tuner more subject to various troubles. Because of the increased gain, microphonics, regeneration and spurious oscillation as well as pickup of image, i.f., and other interference, are more easily caused by mechanical deficiencies. Alignment and all mechanical adjustments are more critical and require more care. In addition, most recent tuner designs are intended for modern compact receivers and are, therefore, limited as to available space. This makes servicing more difficult.

The very existence of remote control devices has also had its impact on the design of tuners. Mechanical remote fine tuning is a rather complicated thing to set up. Variable-capacitor tuning from a remote position is also difficult to arrange, what with the uncertain capacitance of leads between the remote device and the tuner tending to introduce undesired tuning—and detuning—effects.

The result has been the elimination of the traditional fine-tuning variable capacitor on some new front ends, with an electronic means of automatic fine-tuning control—some form of a.f.c.—taking its place instead. Such an arrangement is discussed in "New

Westinghouse TV Circuits," starting on page 54 of our January 1958 issue.

The well-known turret tuner, with its easily removable segments, is less widely used in many of the larger manufacturers' sets; in its place we often find the switch tuner using a version of the "tuned line" circuit. Service technicians who remember the first RCA switch-type tuner, the KRK-2, may not be delighted with the thought of working with that type of circuit again; however, the new switch tuners are not at all as difficult to align and repair as their earliest prototypes. Above all, the circuit is much improved over the original push-pull version and recent examples are more rugged mechanically. Many of these new tuners are used with some kind of power or remote-control tuning device, which eliminates some of the abuse and tampering to which owners of earlier models often subjected sets.

Wafer-Switch Tuners

The basic principle of the wafer-switch tuner, the series-connected coils, will be well known to many. Tuned circuits are adjusted from lower to higher channels by shorting out individual sections. At the lowest channel, all coil sections are in the circuit and, at the highest, only one or two coils are part of the resonant tuning circuit.

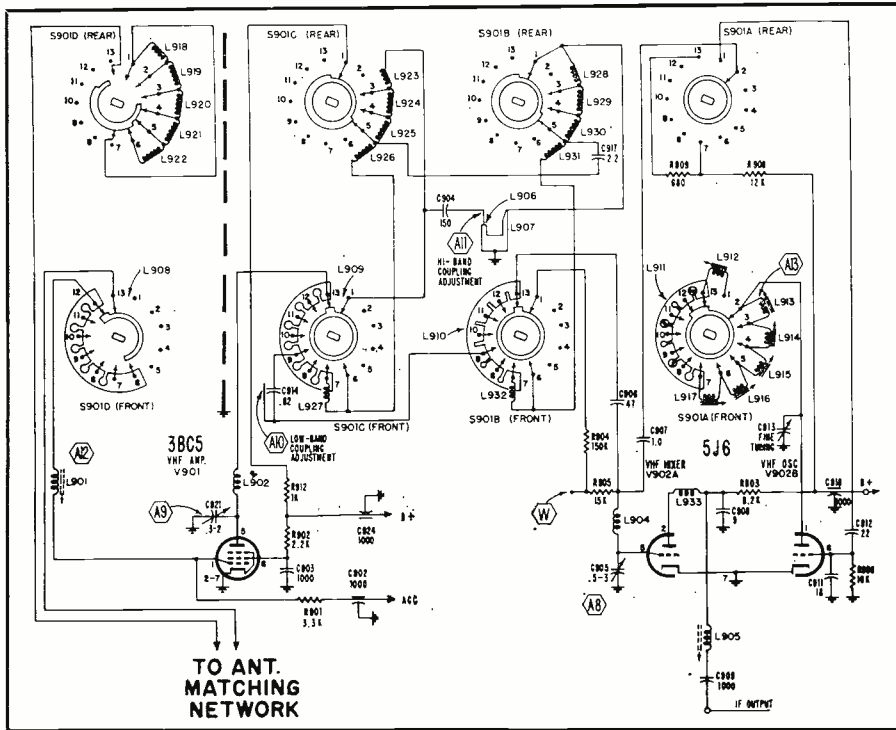

Fig. 3. Schematic for Admiral 94D128-1, using 4 switch-tuned circuits.

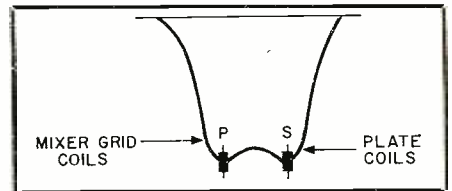

Fig. 6. One string of coils is tuned to affect one side of the response curve, with another set being used to shape the other side of the curve.

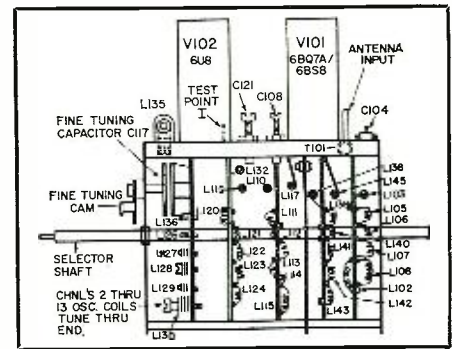

Fig. 7. Mechanical arrangement of the G-E switch-type tuner. The shield plate, right of center, goes between the switch deck for the neutralizing circuits and the r.f. switch deck.

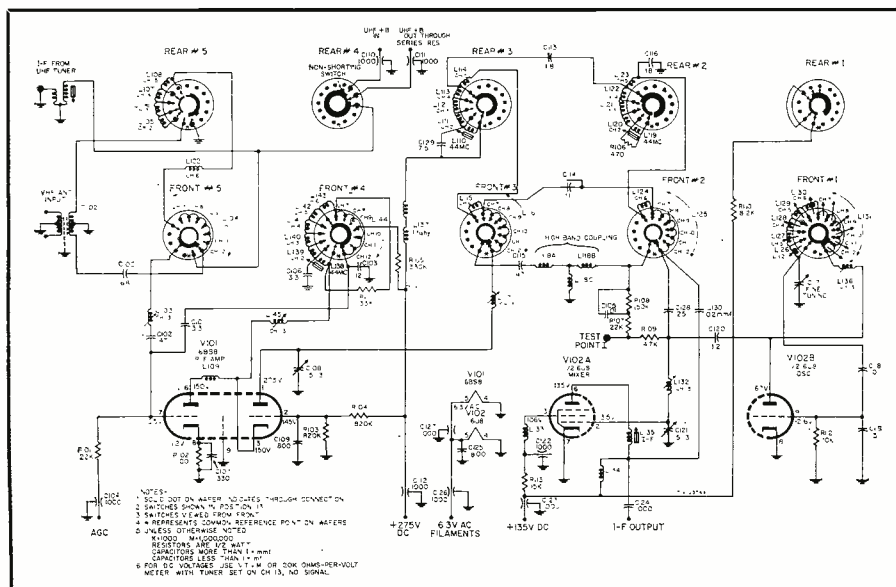

Fig. 4. This G-E switch-type cascode tuner uses a fifth switch deck.

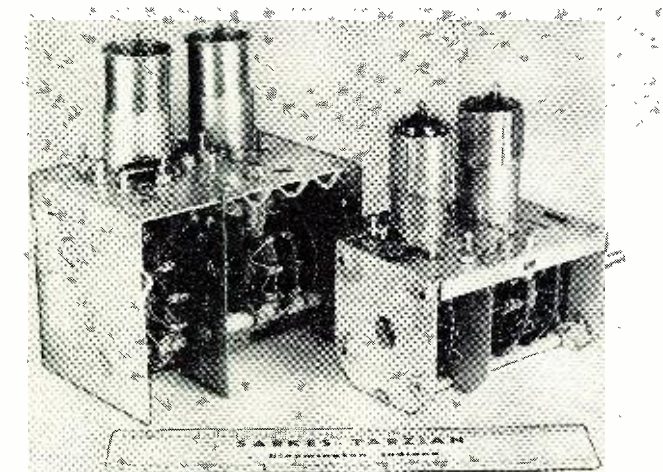

Fig. 5. The Sarkes Tarzian tuner to the right is the latest compact unit available. To its left is an earlier, electrically similar switch tuner, shown for size comparison.

Typical of the circuitry of the new switch-type tuners is the *Admiral 94D128-1*, shown in Figs. 1 and 2. This same tuner, with minor modifications, is manufactured for other companies by *Sarkes Tarzian* and found in other well-known TV sets. The circuit diagram of Fig. 3 shows how each of the four tuned circuits employed is switched for the various channels. Note that only the oscillator resonant circuit has adjustments for each low-band v.h.f. channel and for every other high-band channel. In Figs. 1 and 2, the switch deck closest to the knob end of the shaft is the oscillator deck, which can be adjusted from the front of the tuner by inserting the insulated screwdriver through the various holes provided for this purpose. At the rear of the tuner is the input tuning switch deck, separated from the rest of the tuner by a grounded shield.

One of the interesting features of this tuner is the construction of the high v.h.f. channel-tuning circuit. It consists of a solid strip of silver-plated brass with punched-out circles providing the small incremental inductances needed to tune from one channel to the next. There is no adjustment possible in the r.f. and mixer tuned circuit except for the coils which are in series with each string of punched-out inductances.

Alignment of this tuner is done by adjusting all tuned circuits first at Channel 13, then at Channel 12, and so on down to Channel 2. Oscillator coils can be adjusted by regular tuning screws, but most other coils have to be adjusted by compressing or spreading them apart, a process which requires a little talent and judgment. To adjust the bandpass characteristic of the network coupling the r.f. amplifier

plate and the mixer grid, the coupling between the two is controlled to give the desired slight dip in response characteristic. As shown in Fig. 6, one string of coils is tuned for each side of the response curve and the two coupling circuits are adjusted for the high- and the low-band coupling as separate steps. The latter is simply a wire "gimmick" depending on the capacity of a short length of hook-up wire. To set the coupling at the high v.h.f. band, a U-shaped punched piece serves as a T-network.

The type of tuner just described will be found primarily in low-priced receivers where extreme fringe area performance cannot be expected. The pentode r.f. amplifier used here, in conjunction with the triode mixer, does not provide the ultimate in low noise figure or sensitivity, but performs well in fairly strong signal areas.

In construction, this tuner will be found to be more adaptable to mass production techniques than to simple servicing. Disassembly requires unsoldering some brackets and re-assembly is also quite tricky. Only where the service technician has difficulty getting a replacement tuner should he attempt such major mechanical repairs as replacing individual switch wafers or rewiring tube sockets. If simple defects occur, such as a broken detent spring, open or shorted capacitors or resistors, replacement is not too difficult. Some typical tuner problems such as microphonics, regeneration, and oscillation are harder to handle, since their cause is usually

something not too obvious, such as a poorly soldered chassis ground point or a capacitor leaning too tightly against a switch deck.

The tuner circuit whose schematic is shown in Fig. 4 is mechanically very similar to the one just discussed. The only obvious difference is the addition of a fifth switch deck in Fig. 4 and, of course, the use of a cascode r.f. amplifier and a pentode-triode combination for the oscillator and mixer. The basic circuitry has been in use for several years, but some of the specific features are unusual.

Starting at the center-tapped input transformer, note that one side of the secondary goes to the series of low-channel coils while the other side goes to the high-band channels. For reception through the high band, one portion of the secondary is shorted out, optimizing the impedance match for the antenna input.

Note also how the neutralizing-circuit switch is wired. To reduce the "Q" of the tuner section for the low channels, a resistor (R_{111}) is connected across those coils, while the "B+" voltage for that plate goes through a 330,000-ohm resistor to the tap for Channel 10. To control the dip in the response curve, the coupling between the plate of the r.f. amplifier and the mixer grid is varied. For the low channels, a wire "gimmick" is shunted across a coupling capacitor (C_{111}). Note that another coupling capacitor (C_{112}) goes across at the Channel 5 tap. This gives more uniform band-pass at the lower channels without excess dip at Channel 6. The high-

Fig. 8. The schematic of the pentode version of the disc-type tuner shows that it uses a combination of series coils and sectional tuning elements.

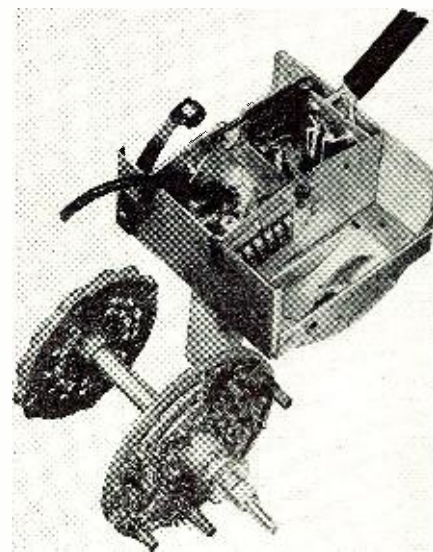
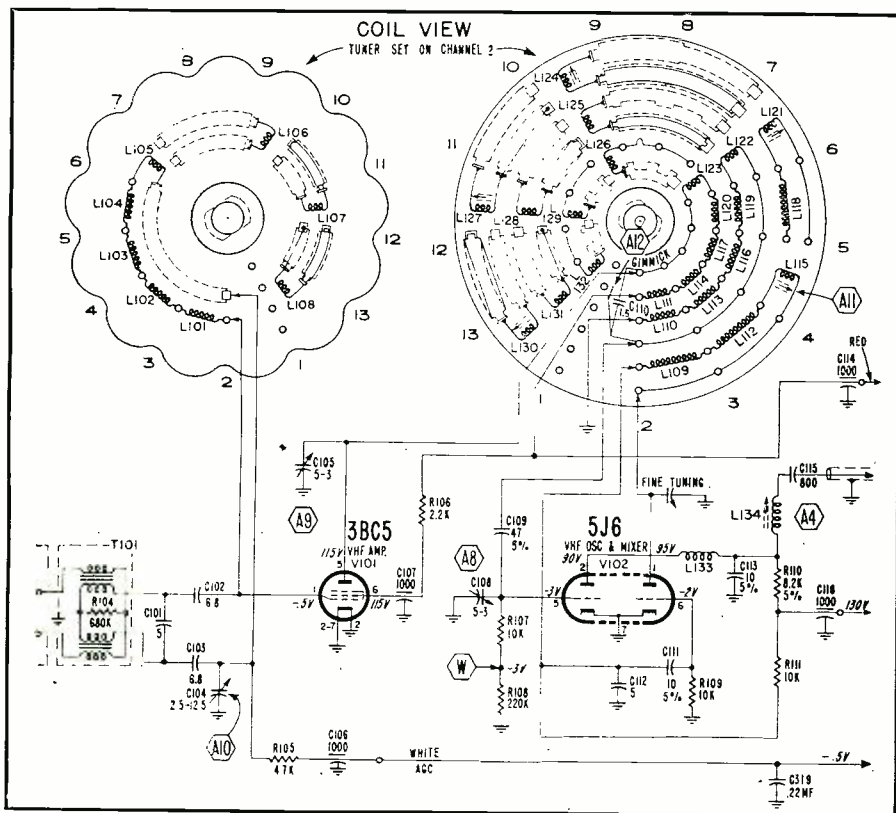

Fig. 9. The disc-type tuner, shown here partially disassembled, could be described as a cross between the more familiar switch and turret types.

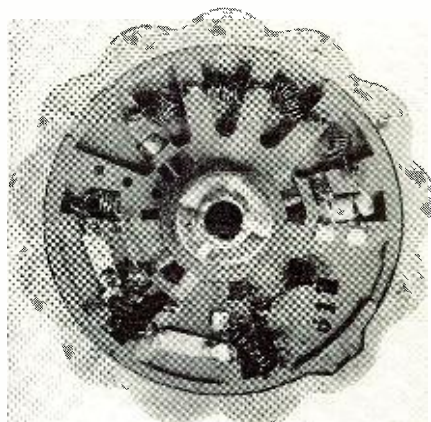
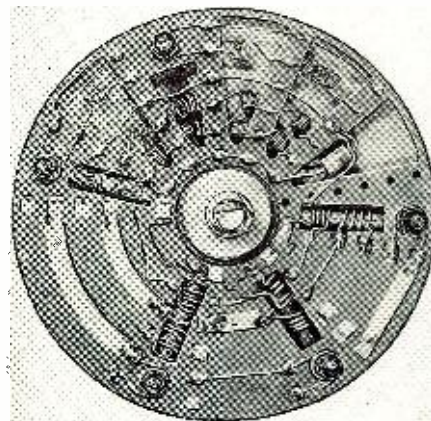

Fig. 10. The dual-contact coil arrangement shown on this disc segment (contacts are on the reverse side) rotates against points on the switch.

Fig. 11. This larger disc, mounted at the front of the disc tuner, carries the tuned circuits for the r.f. amplifier plate and for the mixer grid.



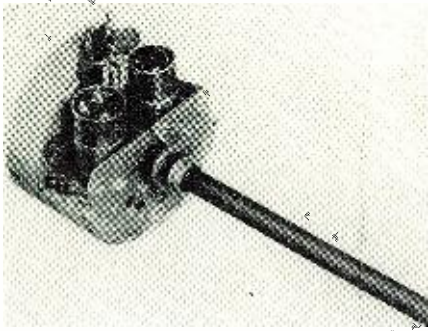

Fig. 12. The Standard Coil "Fireball" tuner features mechanical compactness.

band coupling is achieved through a T-network and must be adjusted by squeezing or spreading the coils. Another unusual feature is the series coil and capacitor filter network at the screen of the mixer tube. Its purpose apparently is to avoid regeneration.

The tuner just described is used in the latest G-E receivers and has 13 switch positions, which include a separate u.h.f. setting for use with an additional u.h.f. tuner. When in the u.h.f. position, the v.h.f. tuner operates at 44 mc., the i.f. of the receiver, and connects the u.h.f. tuner "B+" which is otherwise shut off. When the tuner is switched to any v.h.f. station, the u.h.f. signal is bypassed to ground through the #4 rear switch deck, avoiding spurious pickup.

The mechanical arrangement of this tuner is shown in Fig. 7. The shield plate here goes between the neutralizing switch deck and the plate circuit of the cascade tube. As in all switch tuners, the oscillator coil deck is in front, and this particular switch tuner has adjustments for each channel. Typically, they must be adjusted in sequence, starting with Channel 13 and going down to Channel 2.

The switch tuners described here are made by various TV set makers, as well as by *Sarkes Tarzian, Oak*, and other tuner manufacturers for the set makers. Both in servicing and alignment, all switch tuners have many similarities. Once the service technician has become familiar with them, minor variations in individual manufacturers' models will scarcely be noticed.

Highlighting the trend toward reduced size in the TV receiver, and thus in the tuner as well, is the *Sarkes Tarzian* unit shown to the right in Fig. 5. It is compared to an earlier and electrically similar assembly to the left.

The Disc-Type Tuner

If it were possible to cross-breed a switch-type tuner with the well-known turret tuner, like those made by *Standard Coil*, the resulting hybrid would doubtless look much like the disc tuner shown partially disassembled in Fig. 9. It has the advantage of kidney spring contacts that are self-wiping. Its coils move around stationary contacts and yet two switch wafers are involved. It makes easy repair and alignment possible, and yet is inexpen-

sive to manufacture. Mechanically the input circuit, on a single disc, is automatically separated from other tuned circuits.

The circuit diagram of Fig. 8 demonstrates the differences and features of this new arrangement, which here uses a pentode r.f. amplifier and dual-triode mixer-oscillator. The same type of disc tuner is also made with a neutralized-triode input, or with a pentode r.f. stage and a triode oscillator and mixer. In Figs. 8 and 9, the hybrid nature of this tuner is clearly shown by the combination of series coils and sectional tuning. In the r.f. input disc, for example, between Channels 2 and 6, a series of coils is used just as in a switch-type tuner; but then a completely different coil is switched in for Channels 7, 8, and 9. For Channels 10 and 11 a still different set is connected into the circuit. Again, Channels 12 and 13 have their own coil. This is made possible by the use of dual switch points, mounted stationary, while the dual-contact coil arrangement shown in Fig. 10 rotates against the switch points.

In a similar manner, all tuned circuits are switched. The r.f. amplifier plate and mixer grid circuits are mounted on the larger disc at the front of the tuner, which is shown in detail in Fig. 11. The outer ring is occupied by the oscillator circuits and can, as usual, be tuned from the front of the set. Adjustable coils are only provided for groups of channels, but again the tuned-line concept does not cover the entire v.h.f. band.

Coupling between the r.f. amplifier
(Continued on page 122)

Fig. 13. The latest Neutrode version of the ever-popular Standard Coil turret tuner, as used in a Packard-Bell receiver.

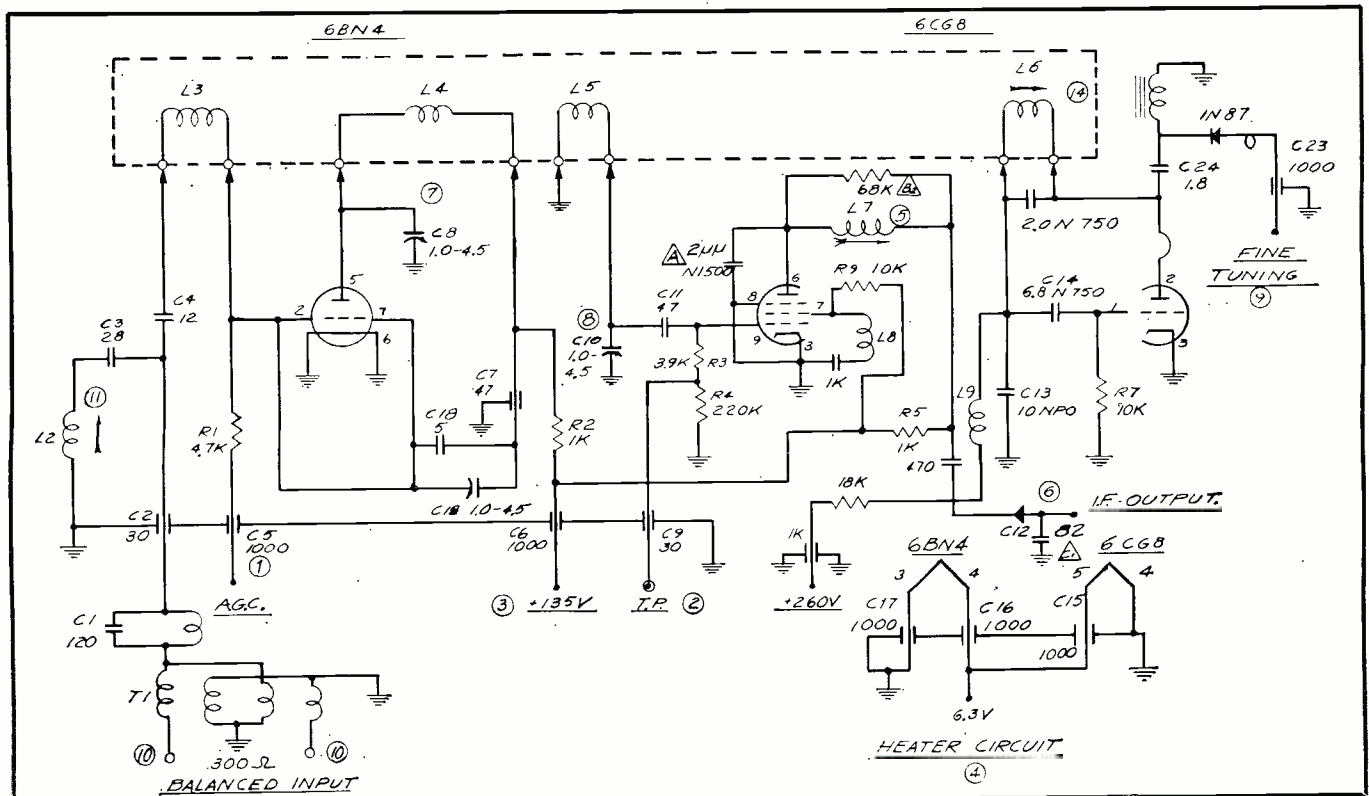

**NEW
COMPLETE**

**DIRECT
VIEWING**

TELEVISION ANALYST

*test each stage
SEPARATELY*

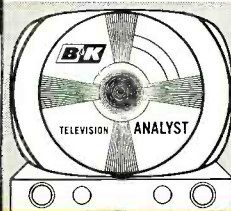
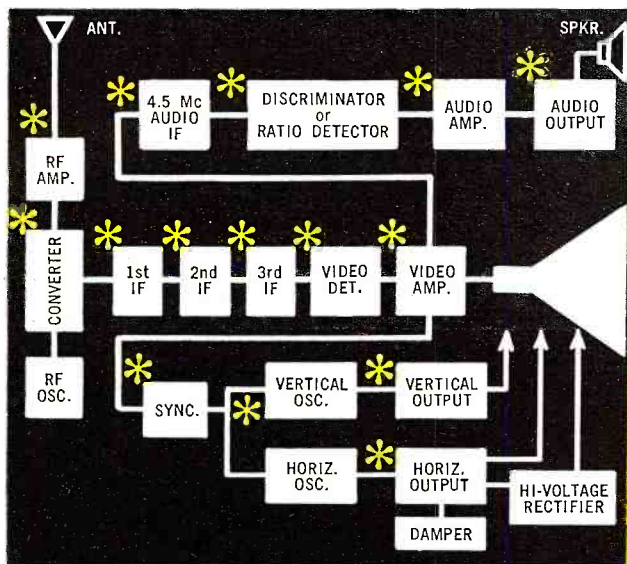

and watch the
result on the
TV set itself

UNIQUE NEW SIGNAL-INJECTION TECHNIQUE
Saves TV Trouble-Shooting Time and Work

- R.F.** Supplies complete r.f. and i.f. signals with video and audio modulation to quickly trouble-shoot each stage in each of the sections of the TV receiver. Enables you to check the r.f. sensitivity and AGC settings of TV receivers.
- I.F.** Reproduces a complete test pattern on the screen of the TV picture tube and injects signals into each video stage of the TV receiver for fast, visual trouble-shooting and correction—anywhere, anytime. Makes it easy to check bandwidth, resolution, shading and contrast capabilities of the TV set.
- VIDEO** Provides composite signal, sync positive and negative.
- SYNC** Provides separate vertical and horizontal driving pulses for trouble-shooting deflection circuits.
- INTERMITTENTS** Test signal injection also aids in locating intermittent troubles.
- AUDIO** Provides a 4.5 mc sound channel, FM modulated with approximately 25 kc deviation. (This audio carrier is modulated either from a built-in 400 cycle tone generator, or from your own external audio source.) Injection of the 400 cycle tone signal simplifies trouble-shooting of the audio section.
- COLOR** Enables you to trouble-shoot and signal trace color circuits in color TV sets.
Generates white dot and crosshatch patterns on the TV screen for color TV convergence adjustments.
Generates full color rainbow pattern of orange, red, magenta, blue, cyan, green to test color sync circuits, check range of hue control, align color demodulators, etc.
- SET ADJUSTMENT** Enables you to check and adjust the vertical and horizontal linearity, size and aspect ratio of television receivers.



NEW



**MODEL
1075**

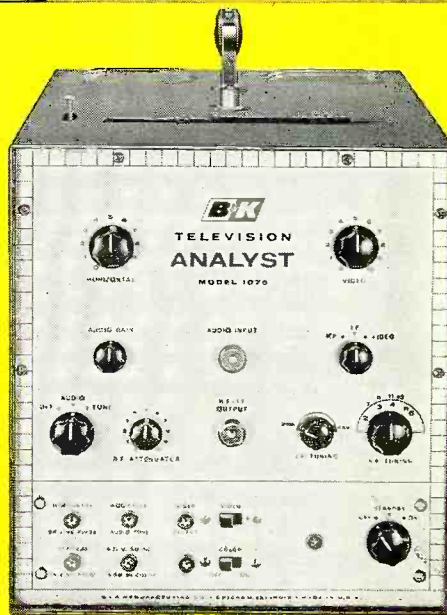

QUICK, DIRECT, COMPLETE TV TROUBLE-SHOOTING

Now, by point-to-point signal injection and test pattern reproduction, you can easily trouble-shoot and signal trace *any stage throughout the video, audio and sweep sections* of black & white and color TV receivers. With the remarkable new Model 1075 B&K TELEVISION ANALYST, you can quickly isolate and diagnose TV troubles (including intermittents). By use of the generated test pattern, you can *actually see* the condition directly on the picture tube of the television set itself. No external scope is needed. The TELEVISION ANALYST is practically a *complete* TV service shop *in one instrument!* Net, \$259⁹⁵



See your B&K Distributor or write for Bulletin 1075-N

B & K MANUFACTURING CO.
3726 N. Southport Ave. • Chicago 13, Illinois

Canada: Atlas Radio Corp., 50 Wingold, Toronto 10, Ont.

Export: Empire Exporters, 458 Broadway, New York 13, U. S. A.

here

we

grow

again

With this issue we introduce our new building—over 140,000 sq. ft. of modern plant equipment under one roof, the largest in the nation devoted to direct mail selling of electronic kits. To you, in the field, goes the credit for the tremendous growth of the electronic industry over recent years. Your imagination, courage and resourcefulness have moved America into the electronic age at a breathtaking pace. A pioneer in "do-it-yourself" electronic kits, Heath Co. has always endeavored to stay out in front. As a result we have grown too—from one small building to a point where we occupied seven buildings in the local area. Our new plant is your assurance of more and better HEATHKITS to come!

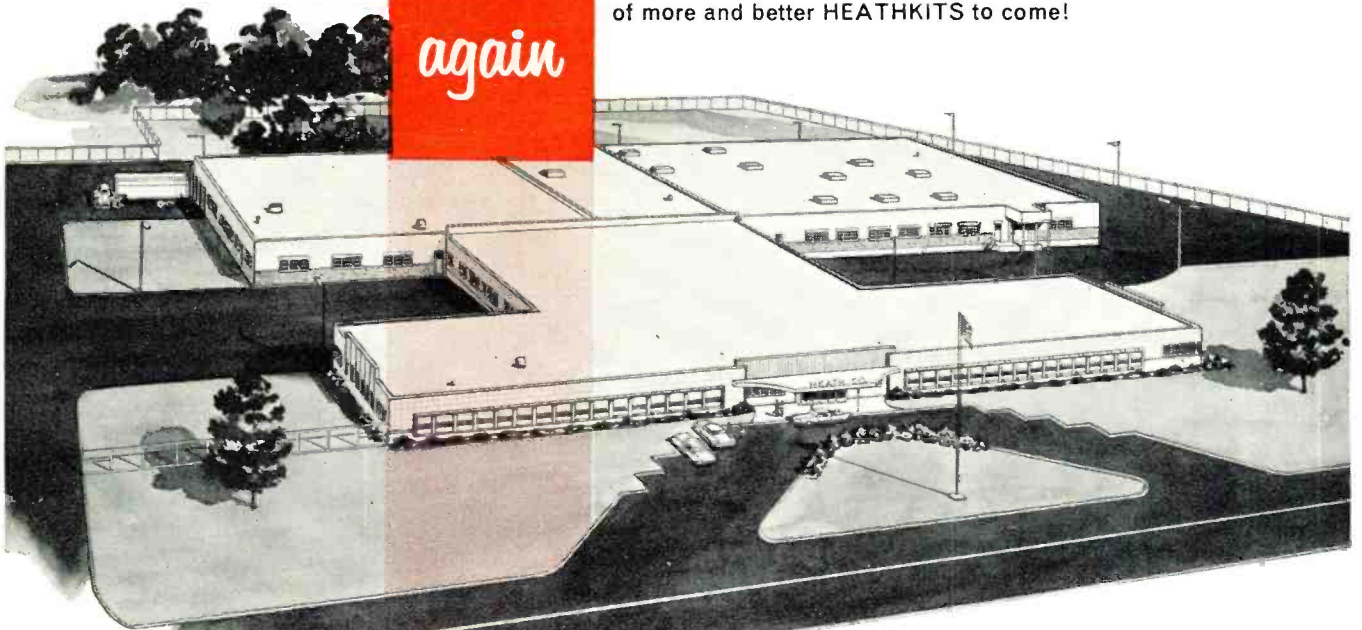

here's what it means to you—



Faster, more efficient handling of orders to speed HEATHKITS to your doorstep.



More for your purchasing dollar through increased efficiency and lower handling costs.



Faster research and development projects bringing you the latest electronic equipment in step with ever-expanding fields.



Better and faster service facilities to help you with any problems and questions you may have,

 a subsidiary of Daystrom, Inc.



HEATH COMPANY, Benton Harbor 15, Mich.

TIME PAYMENTS . . .

The Heath Time Payment Plan was designed for your convenience. Now, you can order the kits of your choice, and pay for them in small monthly installments. Write for full details.

HEATHKIT EXTRA PERFORMANCE 70-WATT AMPLIFIER KIT

For really high performance, with plenty of reserve power, the W-6M is a natural. The full 70-watts output will seldom, if ever, be required. However, this reserve insures distortion-less sound on power peaks. The W-6M will loaf along at normal listening levels and yet is always ready to extend itself when program material demands it, without the least amount of strain. The output circuit employs 6550 tubes with a special-design Peerless output transformer for maximum stability at all power levels. A quick-change plug selects 4, 8 and 16 ohms or 70-volt output and the correct feedback resistance. A variable damping control is also provided for optimum performance with any speaker system. Extremely good power supply regulation is possible through the use of a heavy-duty transformer along with silicon-diode rectifiers, which are noted for their very long life, and yet are smaller than a house fuse. Frequency response at 1 watt is ± 1 db from 5 cps to 80 kc with controlled hf rolloff above 100 kc. At 70 watts output harmonic distortion is below 2%, 20 to 20,000 cps and IM distortion below 1%, 60 and 6,000 cps. Hum and noise 88 db below full output. In addition to high performance, its fine appearance makes it a pleasure to display in your living room. Proper layout of chassis insures ease of assembly by eliminating those cramped and difficult places to get at. Clear instructions—and top-quality components. Get started now and make this amplifier the heart of your hi-fi system. Shipped express only. Shpg. Wt. 50 lbs.

MODEL W-6M

\$109⁹⁵

MODEL W-6: Consists of W-6M kit, plus WA-P2 preamplifier. Express only. Shpg. Wt. 59 lbs. \$129.70

HEATHKIT HIGH FIDELITY FM TUNER KIT

This tuner can bring you a rich store of FM programming, your least expensive source of high fidelity material. It covers the complete FM band from 88 to 108 mc. Stabilized, temperature-compensated oscillator assures negligible drift after initial warmup. Features broadbanded circuits for full fidelity, and better than 10 uv sensitivity for 20 db of quieting, to pull in stations with clarity and full volume. Employs a high gain, cascode RF amplifier, and has AGC. A ratio detector provides high-efficiency demodulation without sacrificing hi-fi performance. IF and ratio transformers are prealigned, as is the front end tuning unit. Special alignment equipment is not necessary. Edge-lighted glass dial for easy tuning. Here is FM for your home at a price you can afford. Shpg. Wt. 8 lbs.

MODEL FM-3A

\$25⁹⁵

(with cabinet)

HEATHKIT BROADBAND AM TUNER KIT

This AM tuner was designed especially for high fidelity applications. It incorporates a special detector using crystal diodes, and the IF circuits feature broad band-width, to insure low signal distortion. Audio response is ± 1 db from 20 cps to 9 kc, with 5 db of preemphasis at 10 kc to compensate for station rolloff. Sensitivity and selectivity are excellent, and tuner covers complete broadcast band from

550 to 1600 kc. Quiet performance is assured by 6 db signal-to-noise ratio at 2.5 UV. Prealigned RF and IF coils eliminate the need for special alignment equipment. Incorporates AVC, two outputs, two antenna inputs, and built-in power supply. Edge-lighted glass slide-rule dial for easy tuning. Your "best buy" in an AM tuner. Shpg. Wt. 8 lbs.

MODEL BC-1A

\$25⁹⁵

(with cabinet)

HEATHKIT MASTER CONTROL PREAMPLIFIER KIT

Designed for use with any of the Williamson-type amplifiers, the WA-P2 has five switch-selected inputs, each having its own level control to eliminate blasting or fading while switching through the various inputs, plus a tape recorder output. A hum control allows setting for minimum hum level. Frequency response is within $\pm 1\frac{1}{2}$ db from 15 to 35,000 cps. Equalization provided for LP, RIAA, AES, and early 78's. Separate bass and treble controls. Low impedance cathode follower output circuit. All components were specially selected for their high quality. Includes many features which will eventually be desired. Shpg. Wt. 7 lbs.

MODEL WA-P2

\$19⁷⁵

(with cabinet)

An amplifier you will be proud to own

70-WATT AMPLIFIER

FM-TUNER

AM-TUNER

Selects and controls sound to your taste

PREAMPLIFIER



ADVANCED-DESIGN
25-WATT AMPLIFIER

*Top performance
in its
power class!*



SINGLE-CHASSIS
20-WATT AMPLIFIER

*Hi-Fi equipment
for your listening
pleasure!*

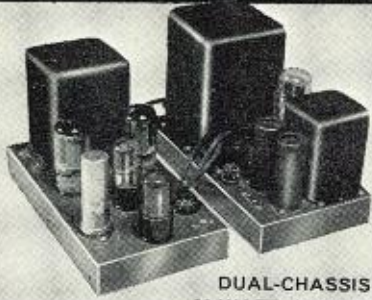

DUAL-CHASSIS
20-WATT AMPLIFIER



GENERAL-PURPOSE
20-WATT AMPLIFIER

HEATHKIT ADVANCED-DESIGN 25-WATT HIGH FIDELITY AMPLIFIER KIT

Designed especially to satisfy critical audio requirements, the W-5M incorporates the extra features needed to complement the finest in program sources and speaker systems. Faithful sound reproduction is assured with a frequency response of ± 1 db from 5 to 160,000 cps at 1 watt, and harmonic distortion is less than 1% at 25 watts, with IM distortion less than 1% at 20 watts. Hum and noise are a full 99 db below rated output, assuring quiet, hum-free operation. Output taps are 4, 8 and 16 ohms. Exclusive Heathkit features include the "tweeter saver", and the "bas-bal" balancing circuit, requiring only a voltmeter for indication. Years of reliable service are guaranteed through the use of conservatively rated, high quality components. KT66 tubes and Peerless output transformer are typical. Shipped express only. Shpg. Wt. 31 lbs.

MODEL W-5: Consists of W-5M kit above plus model WA-P2 preamplifier. Express only. Shpg. Wt. 38 lbs. \$79.50

MODEL W-5M
\$59⁷⁵

HEATHKIT SINGLE-CHASSIS 20-WATT HIGH FIDELITY AMPLIFIER KIT

The model W4-AM Williamson-type amplifier will amaze you with its outstanding performance. A true Williamson circuit, featuring extended frequency response, low distortion, and low hum levels, this amplifier can provide you with many hours of listening enjoyment with only a minimum investment compared to other units on the market. 5881 tubes and a special Chicago-standard output transformer are employed to give you full fidelity at minimum cost. Frequency response extending from 10 cps to 100 kc within ± 1 db at 1 watt assures you of full coverage of the audio range, and clean clear sound amplification takes place in circuits that hold harmonic distortion at 1.5% and IM distortion below 2.7% at full 20 watt output. Hum and noise are 95 db below full output. Taps on the output transformer are at 4, 8 or 16 ohms. Shipped express only. Shpg. Wt. 28 lbs.

MODEL W-4A: Consists of W-4AM kit above, plus model WA-P2 preamplifier. Express only. Shpg. Wt. 35 lbs. \$59.50

MODEL W-4AM
\$39⁷⁵

HEATHKIT DUAL-CHASSIS 20-WATT HIGH FIDELITY AMPLIFIER KIT

The model W3-AM is a Williamson-type amplifier built on two separate chassis. The power supply is on one chassis, and the amplifier stages are on the other chassis. Using two separate chassis provides additional flexibility in installation. Features include the famous acrosound model TO-300 "ultralinear" output transformer and 5881 tubes for broad frequency response, low distortion, and low hum level. The result is exceptionally fine overall tone quality. Frequency response is ± 1 db from 6 cps to 150 kc at 1 watt. Harmonic distortion is less than 1% and IM distortion is less than 1.3% at 20 watts. Hum and noise are 88 db below 20 watts. Designed to match the speaker system of your choice, with taps for 4, 8 or 16 ohms impedance. A very popular high fidelity unit employing top quality components throughout. Shipped express only. Shpg. Wt. 29 lbs.

MODEL W-3A: Consists of W-3AM kit above plus model WA-P2 preamplifier. Express only. Shpg. Wt. 37 lbs. \$69.50

MODEL W-3AM
\$49⁷⁵

Heathkits...

By DAYSTROM

*bring you the lasting satisfaction
of personal accomplishment*

HEATHKIT GENERAL-PURPOSE 20-WATT HIGH FIDELITY AMPLIFIER KIT

The model A-9C will provide you with high quality sound at low cost. Features a built-in preamplifier with four separate inputs, and individual volume, bass and treble controls. Frequency response covers 20 to 20,000 cps within ± 1 db. Total harmonic distortion is less than 1% at 3 db below rated output. Push-pull 6L6 tubes are used, with output transformer tapped at 4, 8, 16 and 500 ohms. A true hi-fi unit using high-quality components throughout, including heavy-duty "potted" transformers. Shpg. Wt. 23 lbs.

MODEL A-9C
\$35⁵⁰

**HEATHKIT "BASIC RANGE"
HI-FI SPEAKER SYSTEM KIT**

The extremely popular Heathkit model SS-1 Speaker System provides amazing high fidelity performance for its size. Features two high-quality Jensen speakers, an 8" mid-range woofer and compression-type tweeter with flared horn. Covers from 50 to 12,000 CPS within ± 5 db, in a special-design ducted-port, bass reflex enclosure. Impedance is 16 ohms. Cabinet measures 11 1/4" H x 23" W x 11 1/4" D. Constructed of veneer-surfaced plywood, 1/2" thick, suitable for light or dark finish. All wood parts are precut and predrilled for easy, quick assembly. Shpg. Wt. 30 lbs.

MODEL SS-1
\$399.5

**HEATHKIT "RANGE EXTENDING"
HI-FI SPEAKER SYSTEM KIT**

Extends the range of the SS-1 to ± 5 db from 35 to 16,000 CPS. Uses 15" woofer and super-tweeter both by Jensen. Kit includes crossover circuit. Impedance is 16 ohms and power rating is 35 watts. Measures 29" H x 23" W x 17 1/2" D. Constructed of veneer-surfaced plywood 3/4" thick. Easy to build! Shpg. Wt. 80 lbs.

MODEL SS-1B
\$999.5

**HEATHKIT "LEGATO"
HIGH FIDELITY SPEAKER SYSTEM KIT**

The quality of the Legato, in terms of the engineering that went into the initial design, and in terms of the materials used in its construction, is matched in only the most expensive speaker systems available today. The listening experience it provides approaches the ultimate in esthetic satisfaction. Two 15" theater-type Altec Lansing speakers cover 25 to 500 CPS, and an Altec Lansing high-frequency driver with sectoral horn covers 500 to 20,000 CPS. A precise amount of phase shift in the crossover network brings the high frequency channel into phase with the low frequency channel to eliminate peaks or valleys at the crossover point, by equalizing the acoustical centers of the speakers. The enclosure is a modified infinite baffle type, especially designed for these speakers. Cabinet is constructed of veneer-surfaced plywood, 3/4" thick, precut and predrilled for easy assembly. Frequency response 25 to 20,000 CPS. Power rating, 50 watts program material. Impedance is 16 ohms. Cabinet dimensions 41" L x 22 1/4" D x 34" H.

Choice of two beautiful cabinets. Model HH-1-C in imported white birch for light finishes, and HH-1-CM in African mahogany for dark finishes. Shpg. Wt. 195 lbs.

MODEL HH-1-C
MODEL HH-1-CM
\$2999.5
EACH

Heathkits...

By DAYSTROM

*let you save up to 1/2
or more on all types
of electronic equipment.*

HEATHKIT SINE-SQUARE GENERATOR

The new AG-10 provides high quality, sine and square waves over a wide range, for countless applications. Some of these are; radio and TV repair work, checking scope performance, as a variable trigger source for telemetering and pulse work, and checking audio, video and hi-fi amplifier response. Frequency response is ± 1.5 db from 20 CPS to 1 MC on both sine and square waves, with less than .25% sine wave distortion, 20 to 20,000 CPS. Sine wave output impedance 600 ohms, square wave output impedance 50 ohms, (except on 10v ranges). Square wave rise time less than .15 usec. Five-position band switch—continuously variable tuning—shielded oscillator circuit—separate step and variable output attenuators in ranges of 10, 1, and .1 volts for both sine and square wave, with extra range of .01 volt on sine wave. Both sine and square wave can be used at the same time without affecting either wave form. Power supply uses silicon-diode rectifiers. Shpg. Wt. 12 lbs.

MODEL AG-10
\$499.5

HEATHKIT AUDIO ANALYZER KIT

The AA-1 is actually three instruments in one compact package. It combines the functions of an AC VTVM, an audio wattmeter, and an intermodulation analyzer. Input and output terminals are combined, and high and low frequency oscillators are built in. VTVM ranges are 0-.01, .03, .1, .3, 1, 3, 10, 30, 100 and 300 volts (RMS). Wattmeter ranges are .15 mw, 1.5 mw, 15 mw, 150 mw, 1.5 w, 15 w and 150 w. IM scales are 1%, 3%, 10%, 30% and 100%. Provides internal load resistors of 4, 8, 16 or 600 ohms. A tremendous dollar value. Shpg. Wt. 13 lbs.

MODEL AA-1
\$499.5

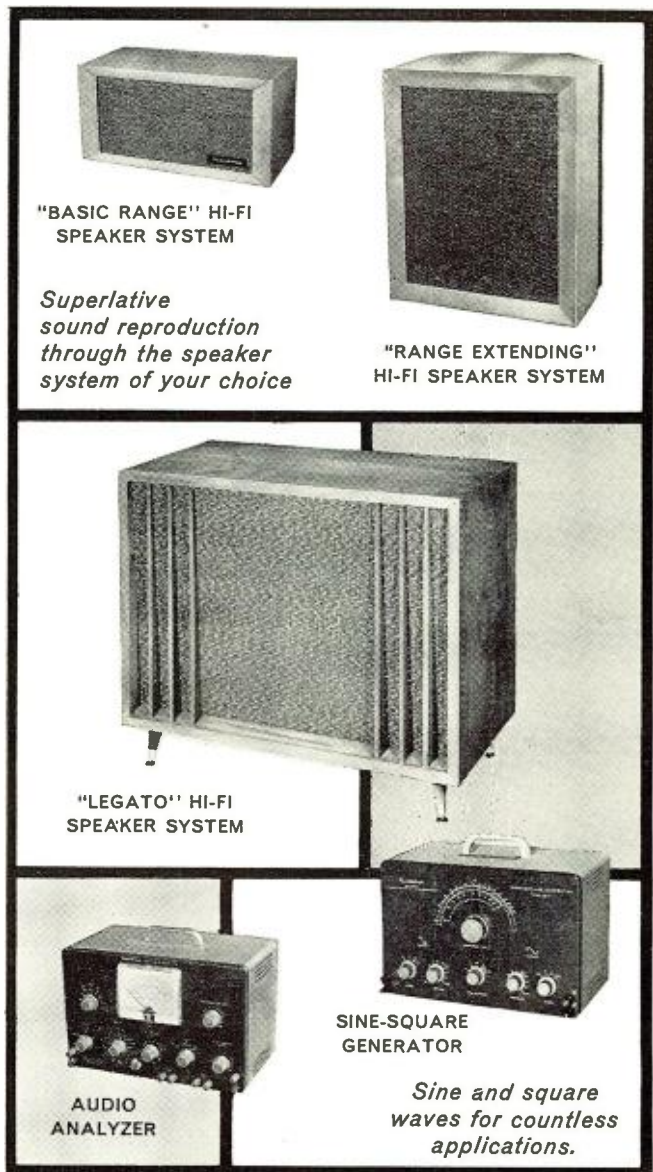

"BASIC RANGE" HI-FI
SPEAKER SYSTEM

*Superlative
sound reproduction
through the speaker
system of your choice*

"RANGE EXTENDING"
HI-FI SPEAKER SYSTEM

"LEGATO" HI-FI
SPEAKER SYSTEM

AUDIO
ANALYZER

SINE-SQUARE
GENERATOR

*Sine and square
waves for countless
applications.*



*Audio
equipment
for your
hi-fi testing*

**GENERAL PURPOSE"
SCOPE**



AUDIO WATTMETER



AUDIO GENERATOR



**HARMONIC
DISTORTION METER**



AUDIO VTVM

HEATHKIT "GENERAL PURPOSE" 5" OSCILLOSCOPE KIT

The model OM-2 Oscilloscope is especially popular with part-time service technicians, students, and high fidelity enthusiasts. It features good vertical frequency response ± 3 db from 4 cps to over 1.2 mc. A full five-inch crt. and sweep generator operation from 20 cps to over 150 kc. Stability is excellent and calibrated grid screen allows precise signal observation. Extra features include external or internal sweep and sync, 1-volt peak-to-peak calibrating reference, 3-position step-attenuated input, adjustable spot shape control, push-pull horizontal and vertical amplifiers, and modern etched-metal circuits. Easy to build and a pleasure to use. Ideal for use with other audio equipment for checking amplifiers. Shpg. Wt. 21 lbs.

MODEL OM-2

\$39⁹⁵

HEATHKIT AUDIO WATTMETER KIT

The AW-1 Audio Wattmeter can be used in any application where audio power output is to be measured. Non-inductive LOAD resistors are built in for 4, 8, 16 or 600 ohms impedance. Five power ranges cover 0-5 mw, 50 mw, 500 mw, 5 w, and 50 w full scale. Five switch-selected db ranges cover -10 db to +30 db. All indications are read directly on a large 4½" 200 microampere meter. Frequency response is

± 1 db from 10 cps to 250 kc. Precision type multiplier resistors used for high accuracy, and crystal diode bridge for wide-range frequency response. This meter is used in many recording studios and broadcast stations as a monitor as well as servicing. A fine meter to help supply the answers to your audio operating or power output problems. Shpg. Wt. 6 lbs.

MODEL AW-1

\$29⁵⁰

HEATHKIT AUDIO SIGNAL GENERATOR KIT

The model AG-9A is "made to order" for high fidelity applications, and provides quick and accurate selection of low-distortion signals throughout the audio range. Three rotary switches select two significant figures and a multiplier to determine audio frequency. Incorporates step-type and a continuously variable output attenuator. Output indicated on large 4½" panel meter, calibrated in volts and db. Attenuator system operates in 10 db steps, corresponding to meter calibration, in ranges of 0-.003, .01, .03, .1, .3, 1, 3 and 10 volts RMS. "Load" switch permits use of built-in 600-ohm load, or external load of different impedance. Output and frequency indicators accurate to within $\pm 5\%$. Distortion less than .1 of 1% between 20 and 20,000 cps. Total range is 10 cps to 100 kc. Shpg. Wt. 8 lbs.

MODEL AG-9A

\$34⁵⁰

HEATHKIT HARMONIC DISTORTION METER KIT

All sounds consist of dominant tones plus harmonics (overtones). These harmonics enrich the quality and brightness of the music. However, additional harmonics which originate in the audio equipment, represent distortion. Used with an audio signal generator, the HD-1 will accurately measure this harmonic distortion at any or all frequencies between 20 and 20,000 cps. Distortion is read directly on the panel meter in ranges of 0-1, 3, 10, 30 and 100% full scale. Voltage ranges of 0-1, 3, 10 and 30 volts are provided for the initial reference settings. Signal-to-noise ratio measurements are also permitted through the use of a separate meter scale calibrated in db. High quality components insure years of outstanding performance. Full instructions are provided. Shpg. Wt. 13 lbs.

MODEL HD-1

\$49⁵⁰

Heathkits..

By DAYSTROM

*are well known for
their high quality
and reliability.*

HEATHKIT AUDIO VTVM KIT

This new and improved AC Vacuum Tube Voltmeter is designed especially for audio measurements and low-level AC measurements in power supply filters, etc. Employs an entirely new circuit featuring a cascode amplifier with cathode-follower isolation between the input and the amplifier, and between the output stage and the preceding stages. It emphasizes stability, broad frequency response, and sensitivity. Frequency response is essentially flat from 10 cps to 200 kc. Input impedance is 1 megohm at 1000 cps. AC (RMS) voltage ranges are 0-.01, .03, .1, .3, 1, 3, 10, 30, 100 and 300 volts. Db ranges cover -52 db to +52 db. Features large 4½" 200 microampere meter, with increased damping in meter circuit for stability in low frequency tests. 1% precision resistors employed for maximum accuracy. Stable, reliable performance in all applications. Shpg. Wt. 5 lbs.

MODEL AV-3

\$29⁹⁵

RADIO & TV NEWS

HEATHKIT COLOR BAR AND DOT GENERATOR

The CD-1 combines the two basic color service instruments, a Color Bar Generator and White Dot Generator in one versatile portable unit, which has crystal-controlled accuracy and stability (no external sync lead required). Produces white dots, cross hatch, horizontal and vertical bars, 10 vertical color bars, and a new shading bar pattern for screen and background adjustments. Variable RF output on any channel from 2 to 6. Positive or negative video output, variable from 0 to 10 volts peak-to-peak. Crystal controlled sound carrier with off-on switch. Voltage regulated power supply using long-life silicon rectifiers. Gain knowledge of a new and profitable field by constructing this kit. Shpg. Wt. 12 lbs.

MODEL CD-1
\$59⁹⁵

HEATHKIT "EXTRA DUTY" 5" OSCILLOSCOPE KIT

This fine oscilloscope compares favorably to other scopes costing twice its price. It contains the extra performance so necessary for monochrome and color-TV servicing. Features push-pull horizontal and vertical output amplifiers, a 5UPI CRT, built in peak-to-peak calibration source, a fully compensated 3-position step-type input attenuator, retrace blanking, phasing control, and provision for Z-axis modulation. Vertical amplifier frequency response is within +1.5 and -5 db from 3 CPS to 5 MC. Response at 3.58 MC down only 2.2 db. Sensitivity is 0.025 volts RMS/inch at 1 kc. Sweep generator covers 20 CPS to 500 kc in five steps, five times the usual sweep obtained in other scopes through the use of the patented Heath sweep circuit. Etched-metal circuit boards reduce assembly time and minimize errors in assembly, and more importantly, permit a level of circuit stability never before achieved in an oscilloscope of this type. Shpg. Wt. 21 lbs.

MODEL O-12
\$64⁹⁵

Heathkits...

BY DAYSTROM

are guaranteed to meet or exceed advertised specifications

HEATHKIT ELECTRONIC SWITCH KIT

A valuable accessory for any oscilloscope owner. It allows simultaneous oscilloscope observation of two signals by producing both signals, alternately, at its output. Four switching rates. Provides gain for input signals. Frequency response ± 1 db, 0 to 100 kc. A sync output is provided to control and stabilize scope sweep. Ideal for observing input and output of amplifiers simultaneously. Shpg. Wt. 8 lbs.

MODEL S-3
\$21⁹⁵

HEATHKIT TV ALIGNMENT GENERATOR KIT

This fine TV alignment generator offers stability and flexibility difficult to obtain even in instruments costing several times this low Heathkit price. It covers 3.6 mc to 220 mc in four bands. Sweep deviation is controllable from 0 to 42 mc. The all-electronic sweep circuit insures stability. Crystal marker and variable marker oscillators are built in. Crystal (included with kit) provides output at 4.5 mc and multiples thereof. Variable marker provides output from 19 to 60 mc on fundamentals and from 57 to 180 mc on harmonics. Effective two-way blanking to eliminate return trace. Phasing control. Kit is complete, including three output cables. Shpg. Wt. 16 lbs.

MODEL TS-4A
\$49⁵⁰

HEATHKIT VOLTAGE CALIBRATOR KIT

This unit is an excellent companion for your oscilloscope. Used as a source of calibrating voltage, it produces near-perfect square wave signals of known amplitude. Precision 1% attenuator resistors insure accurate output amplitude, and multivibrator circuit guarantees good sharp square waves. Output frequency is approximately 1000 CPS. Fixed outputs selected by panel switches are; .03, 0.1, 0.3, 1.0, 3.0, 10, 30 and 100 volts peak-to-peak. Allows measurement of unknown signal amplitude by comparing it to the known output of the VC-3 on oscilloscope. Shpg. Wt. 4 lbs.

MODEL VC-3
\$12⁵⁰

Functional styling with clean uncluttered look



COLOR BAR AND DOT GENERATOR

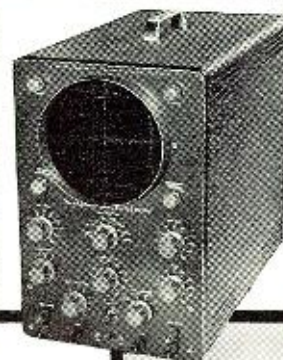

"EXTRA DUTY" SCOPE

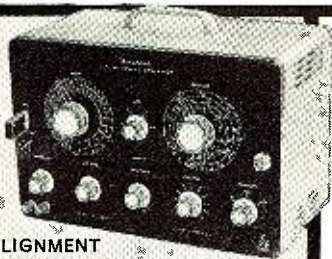

TV ALIGNMENT GENERATOR



ELECTRONIC SWITCH



VOLTAGE CALIBRATOR

HEATHKIT TUBE CHECKER KIT

Eliminate guesswork, and save time in servicing or experimenting. The TC-2 tests tubes for shorted elements, open elements, filament continuity, and operating quality on the basis of total emission. It tests all tube types encountered in radio and TV service work. Sockets are provided for 4, 5, 6 and 7-pin, octal, and loctal tubes, 7 and 9 pin miniature tubes, 5 pin hytron miniatures, and pilot lamps. Tube condition indicated on 4½" meter with multi-color "good-bad" scale. Illuminated roll chart with all test data built in. Switch selection of 14 different filament voltages from .75 to 117 volts. Color-coded cable harness allows neat professional wiring and simplifies construction. Very easy to build, even for a beginner. Shpg. Wt. 12 lbs.

MODEL TC-2
\$29.50

HEATHKIT HANDITESTER KIT

The small size and rugged construction of this tester makes it perfect for any portable application. The combination function-range switch simplifies operations. Measures AC or DC voltage at 0-10, 30, 300, 1000 and 5000 volts. Direct current ranges are 0-10 ma and 0-100 ma. Ohmmeter ranges are 0-3000 (30 ohm center scale) and 0-300,000 (3000 ohm center scale). Very popular with home experimenters, electricians, and appliance repairmen. Slips easily into your tool box, glove compartment, coat pocket, or desk drawer. Shpg. Wt. 3 lbs.

MODEL M-1
\$17.95

HEATHKIT PICTURE TUBE CHECKER KIT

The CC-1 can be taken with you on service calls so that you can clearly demonstrate the quality of a customer's picture tube in his own home. Tubes can be tested without removing them from the receiver or cartons if desired. Checks cathode emission, beam current, shorted elements, and leakage between elements in electromagnetic picture tube types. Self-contained power supply, and large 4½" meter. CRT condition indicated on "good-bad" scale. Relative condition of tubes fluorescent coating is shown in "shadow-graph" test. Permanent test cable with CRT socket and anode connector. No tubes to burn out, designed to last a lifetime. Luggage-type portable case. Shpg. Wt. 10 lbs.

MODEL CC-1
\$24.95

HEATHKIT ETCHED-CIRCUIT VTVM KIT

This multi-purpose VTVM is the world's largest selling instrument of its type—and is especially popular in laboratories, service shops, home workshops and schools. It employs a large 4½" panel meter, precision 1% resistors, etched metal circuit board, and many other "extras" to insure top quality and top performance. It's easy to build, and you may rely on its accuracy and dependability. The V7-A will measure AC (RMS) and DC voltages in ranges of 0-1.5, 5, 15, 50, 150, 500 and 1500. It measures peak-to-peak AC voltage in ranges of 0-4, 14, 40, 140, 400, 1400 and 4000. Resistance ranges provide multiplying factors of X 1, X 10, X 100, X 1000, X 10k, X 100k, and X 1 megohm. Center-scale resistance readings are 10, 100, 1000, 10k, 100k, 1 megohm and 10 megohms. A db scale is also provided. The precision and quality of this VTVM cannot be duplicated at this price. Shpg. Wt. 7-lbs.

MODEL V7-A
\$24.50

Heathkits...

By DAYSTROM

*let you fill your exact needs
from a wide variety
of instruments*

HEATHKIT 20,000 OHMS/VOLT VOM KIT

This fine instrument provides a total of 25 meter ranges on its two-color scale. It employs a 50 ua 4½" meter, and features 1% precision multiplier resistors. Requires no external power. Ideal for portable applications. Sensitivity is 20,000 ohms-per-volt DC and 5000 ohms-per-volt AC. Measuring ranges are 0-1.5, 5, 50, 150, 500, 1500 and 5000 volts, AC and DC. Measures direct current in ranges of 0-150 ua, 15 ma, 150 ma, 500 ma and 15 a. Resistance multipliers are X 1, X 100 and X 10,000, with center-scale readings of 15, 1500 and 150,000 ohms. Covers -10 db to +65 db. Easy to build and fun to use. Attractive bakelite case with plastic carrying handle. Shpg. Wt. 6 lbs.

MODEL MM-1
\$29.95



TUBE CHECKER



*High quality
test gear you
will be
proud to own*

**ETCHED
CIRCUIT VTVM**



*Priced low
to fit your
budget*

HANDITESTER



**PICTURE TUBE
CHECKER**



**20,000
OHMS/VOLT VOM**

HEATHKIT RF SIGNAL GENERATOR KIT

Even a beginner can build this prealigned signal generator, designed especially for use in service work. Produces RF signals from 160 kc to 110 mc on fundamentals in five bands. Covers 110 mc to 220 mc on calibrated harmonics. Low impedance RF output in excess of 100,000 microvolts, is controllable with a step-type and continuously variable attenuator. Selection of unmodulated RF, modulated RF, or audio at 400 CPS. Ideal for fast and easy alignment of radio receivers, and finds application in FM and TV work as well. Thousands of these units are in use in service shops all over the country. Easy to build and a real time saver, even for the part-time service technician or hobbyist. Shpg. Wt. 8 lbs.

MODEL SG-8

\$19.50

HEATHKIT LABORATORY RF GENERATOR KIT

Tackle all kinds of laboratory alignment jobs with confidence by employing the LG-1. It features voltage-regulated B+, double shielding of oscillator circuits, copper-plated chassis, variable modulation level, metered output, and many other "extras" for critical alignment work. Generates RF signals from 100 kc to 30 mc on fundamentals in five bands. Meter reads RF output in microvolts or modulation level in percentage. RF output available up to 100,000 microvolts, controlled by a fixed-step and a variable attenuator. Provision for external modulation where necessary. Buy and use this high-quality RF signal generator that may be depended upon for stability and accuracy. Shpg. Wt. 16 lbs.

MODEL LG-1

\$48.95

HEATHKIT DIRECT-READING CAPACITY METER KIT

Here's a fast, simple capacity meter. A capacitor to be checked is merely connected to the terminals, the proper range selected, and the value read directly on the large 4½" panel meter calibrated in mmf and mfd. Ranges are 0 to 100 mmf, 1,000 mmf, .01 mfd, .1 mfd full scale. Not affected by hand capacity. Shpg. Wt. 7 lbs.

MODEL CM-1

\$29.50

Heathkits...

By DAYSTROM

*are educational
as well as functional*

HEATHKIT "IN-CIRCUIT" CAPACI-TESTER KIT

With the CT-1 it is no longer necessary to disconnect one capacitor lead to check the part, you can check most capacitors for "open" or "short" right in the circuit. Fast and easy—to save your valuable time in the service shop or lab. Detects open capacitors from about 50 mmf up, so long as the capacitor is not shunted by excessively low resistance value. Will detect shorted capacitors up to 20 mfd (not shunted by less than 10 ohms). (Does not detect leakage.) Employs 60 cycles and .19 megacycle test frequencies. Electron beam "eye" tube used as indicator. Compact, easy-to-build, and inexpensive. Test leads included. Shpg. Wt. 5 lbs.

MODEL CT-1

\$7.95

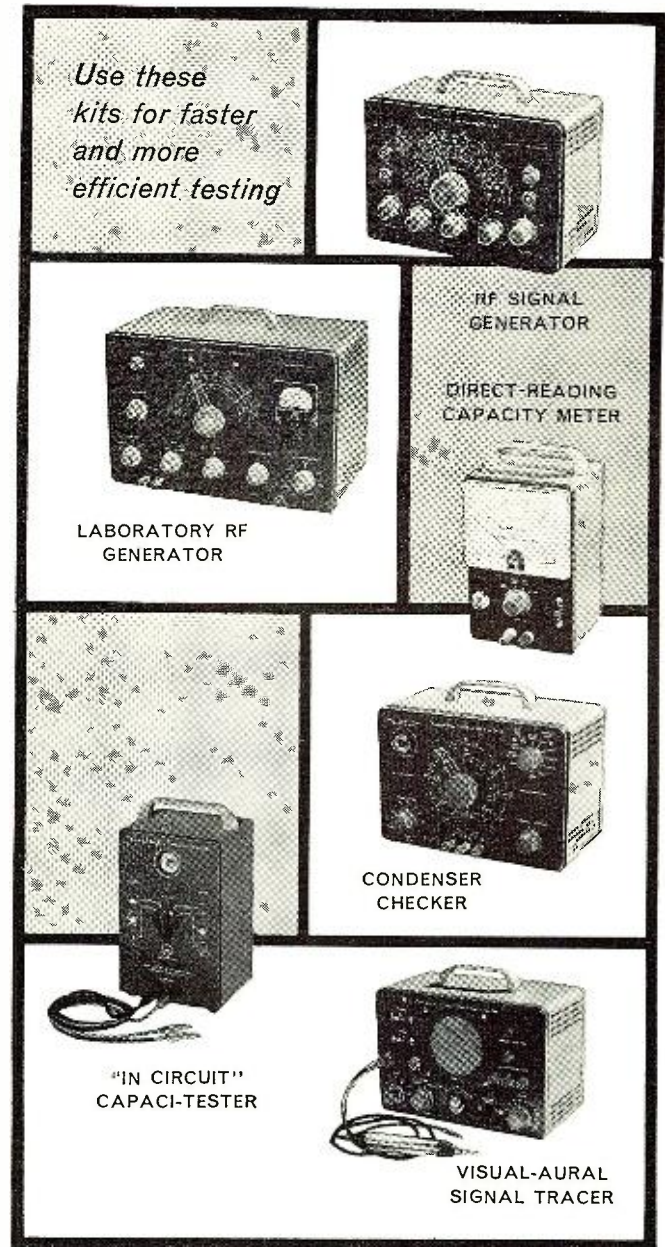

HEATHKIT CONDENSER CHECKER KIT

This handy instrument uses an electron beam "eye" tube as an indicator to measure capacity in ranges of .00001 to .005 mfd, .5 mfd, 50 mfd and 1000 mfd. Also measures resistance from 100 ohms to 5 megohms in two ranges. Checks paper, mica, ceramic and electrolytic capacitors. Selection of five polarizing voltages. Shpg. Wt. 7 lbs.

MODEL C-3

\$19.50

HEATHKIT VISUAL-AURAL SIGNAL TRACER KIT

Although designed originally for radio receiver work, the T-3 finds application in FM and TV servicing as well. Features high-gain channel with demodulator probe, and low-gain channel with audio probe. Traces signals in all sections of radio receivers and in many sections of FM and TV receivers. Built-in speaker and electron beam eye tube indicate relative gain, etc. Also features built-in noise locator circuit. Provision for patching speaker and/or output transformer to external set. Shpg. Wt. 9 lbs.

MODEL T-3

\$23.50

HEATHKIT IMPEDANCE BRIDGE KIT

The model IB-2A employs a Wheatstone Bridge, a Capacity Comparison Bridge, a Maxwell Bridge, and a Hay Bridge in one compact package. Measures resistance from 0.1 ohm to 10 megohms, capacitance from 100 mmf to 100 mfd, inductance from 0.1 mh to 100 h, dissipation factor (D) from 0.002 to 1, and storage factor (Q) from 0.1 to 1000. A 100-0-100 ua meter provides for null indications. The decade resistors employed are of 1% tolerance for maximum accuracy. Completely self-contained. Has built in power supply, 1000-cycle generator, and vacuum-tube detector. Special two-section CRL dial insures convenient operation. Instruction manual has entirely new schematic that clarifies circuit functions in various switch positions. A true laboratory instrument, that will provide you with many years of fine performance. Shpg. Wt. 12 lbs.

MODEL IB-2A

\$59.50

HEATHKIT "LOW RIPPLE" BATTERY ELIMINATOR KIT

This modern battery eliminator incorporates an extra low-ripple filter circuit so that it can be used to power all the newest transistor-type circuits requiring 0 to 12 volts DC,

and the new "hybrid" automobile radios using both transistors and vacuum tubes. Its DC output, at either 6 or 12 volts, contains less than .3% AC ripple. Separate output terminals are provided for low-ripple or normal filtering. Supplies up to 15 amps on 6 volt range or up to 7 amps on 12 volt range. Output is variable from 0 to 8 or 0 to 16 volts. Two meters constantly monitor output voltage and current. Will also double as a battery charger. Shpg. Wt. 23 lbs.

MODEL BE-5

\$39.95

HEATHKIT ISOLATION TRANSFORMER KIT

The model IT-1 is one of the handiest units for the service shop, home workshop or laboratory. Provides complete isolation from the power line. AC-DC sets may be plugged directly into the IT-1 without the chassis becoming "hot". Output voltage is variable from 90 volts to 130 volts allowing checks of equipment under adverse conditions such as low line voltage. Rated for 100 volt amperes continuously or 200 volt amperes intermittently. Panel meter monitors output voltage. Shpg. Wt. 9 lbs.

MODEL IT-1

\$16.50

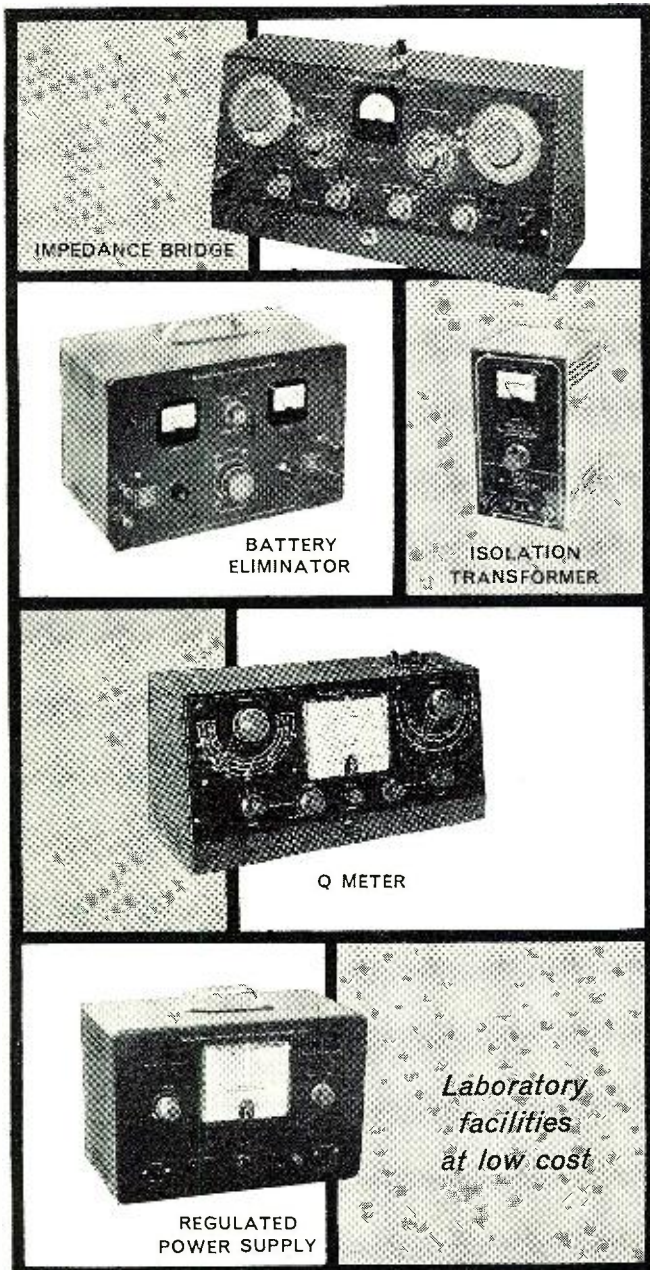

IMPEDANCE BRIDGE

BATTERY ELIMINATOR

ISOLATION TRANSFORMER

Q METER

REGULATED POWER SUPPLY

Laboratory facilities at low cost

Heathkits...

By DAYSTROM

are designed with high-quality, name-brand components to insure long service life

HEATHKIT "Q" METER KIT

At this price the laboratory facilities of a Q Meter may be had by the average service technician or home experimenter. The Q Meter permits measurement of inductance from 1 microhenry to 10 millihenry, "Q" on a scale calibrated up to 250 full scale, with multipliers of 1 or 2, and capacitance from 40 mmf to 450 mmf \pm 3 mmf. Built in oscillator permits testing components from 150 kc to 18 mc. Large 4 1/2" panel meter is featured. Very handy for checking peaking coils, chokes, etc. Use to determine values of unknown condensers, both variable and fixed, compile data for coil winding purposes, or measure RF resistance. Also checks distributed capacity and Q of coils. No special equipment is required for calibration. A special test coil is furnished, along with easy-to-follow instructions. Shpg. Wt. 14 lbs.

MODEL QM-1

\$44.50

HEATHKIT REGULATED POWER SUPPLY KIT

Here is a power supply that will provide DC plate voltage and AC filament voltage for all kinds of experimental circuits. The DC supply is regulated for stability, and yet the amount of DC output voltage available from the power supply can be controlled manually from 0 up to 500 volts. At 450 volts DC output, the power supply will provide up to 10 ma of current, and provide progressively higher current as the output voltage is lowered. Current rating is 130 ma at 200 volts output. In addition to furnishing B+ the power supply also provides 6.3 volts AC at up to 4 amperes for filaments. Both the B+ output and the filament output are isolated from ground. Ideal unit for use in laboratory, home workshop, ham shack, or service shop. A large 4 1/2" meter on the front panel reads output voltage or output current, selectable with a panel switch. Shpg. Wt. 17 lbs.

MODEL PS-3

\$35.00



*Terrific values
in amateur
equipment!*

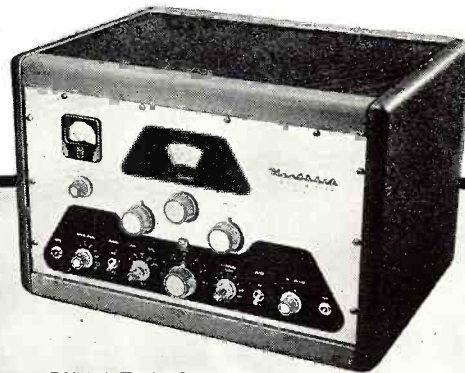

DX-100 TRANSMITTER



DX-20 TRANSMITTER



DX-40 TRANSMITTER

HEATHKIT DX-20 CW TRANSMITTER KIT

The Heathkit model DX-20 "straight-CW" transmitter features high efficiency at low cost. It uses a single 6DQ6A tube in the final amplifier stage for plate power input of 50 watts. A 6CL6 serves as crystal oscillator, with a 5U4GB rectifier. It is an ideal transmitter for the novice, as well as the advanced-class CW operator. Single-knob band switching is featured to cover 80, 40, 20, 15, 11 and 10 meters. Pi network output circuit matches various antenna impedances between 50 and 1000 ohms and reduces harmonic output. Top-quality parts are featured throughout, including "potted" transformers, etc., for long life. It has been given full "TVI" treatment. Access into the cabinet for crystal changing is provided by a removable metal pull-out plug on the left end of the cabinet. Very easy to build from the complete step-by-step instructions supplied, even if you have never built electronic equipment before. If you appreciate a good, clean signal on the CW bands, this is the transmitter for you! Shpg. Wt. 18 lbs.

MODEL DX-20

\$35⁹⁵

a most attractive appearance, and is designed for complete shielding to minimize TVI. A 4-position switch provides convenient selection of three different crystals or a jack for external VFO. The crystals are reached through access door at rear of cabinet. You can build this rig yourself and be proud to show it off to your fellow hams. Get your DX-40 now for many hours of operating enjoyment. Shpg. Wt. 25 lbs.

MODEL DX-40

\$64⁹⁵

HEATHKIT DX-100 PHONE AND CW TRANSMITTER KIT

Listen to any ham band between 160 meters and 10 meters and note how many DX-100 transmitters you hear! The number of these fine rigs now on the air testifies to the enthusiasm with which it has been accepted by the amateur fraternity. No other transmitter in this power class combines high quality and real economy so effectively. The DX-100 features a built in VFO, modulator and power supplies, complete shielding to minimize TVI, and pi network output coupling to match impedances from approximately 50 to 600 ohms. Its RF output is in excess of 100 watts on phone and 120 watts on CW, for a clean strong signal on all the ham bands from 10 to 160 meters. Single-knob band switching and illuminated VFO dial and meter face add real operating convenience. RF output stage uses a pair of 6146 tubes in parallel, modulated by a pair of 1625's. High quality components are used throughout, such as "potted" transformers, silver-plated or solid coin silver switch terminals, aluminum heat-dissipating caps on the final tubes, copper plated chassis, etc. This transmitter was designed exclusively for easy step-by-step assembly. Shpg. Wt. 107 lbs.

MODEL DX-100

\$189⁵⁰

Heathkits . . .

By DAYSTROM

*are designed by
licensed ham-engineers,
especially for you*

HEATHKIT DX-40 PHONE AND CW TRANSMITTER KIT

A most remarkable power package for the price, the new DX-40 provides both phone and CW facilities for operation on 80, 40, 20, 15, 11 and 10 meters. A single 6146 tube is used in the final amplifier stage to provide full 75 watt plate power input on CW, or control carrier modulation peaks up to 60 watts for phone operation. Modulator and power supplies are built right in and single knob bandswitching is combined with a pi network output circuit for complete operating convenience. The tight fitting cabinet presents

FUNCTIONAL DESIGN . . .

The transmitters described on this page were designed for the ham, by hams who know what features are desirable and needed. This assures you of the best possible performance and convenience, and adds much to your enjoyment in the ham shack.

Automatically turns off transmitter and gives visual signal

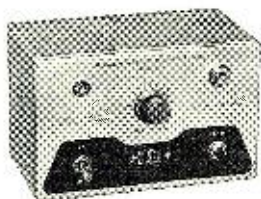

"AUTOMATIC"
CONELRAD ALARM



GRID DIP METER

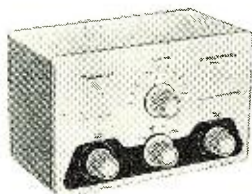

"Q" MULTIPLIER



COMMUNICATIONS-TYPE
RECEIVER

*An ideal receiver
for the beginning
ham or short
wave listener*

HEATHKIT "AUTOMATIC" CONELRAD ALARM KIT

This conelrad alarm works with any radio receiver; AC-DC-transformer operated—or battery powered, so long as the receiver has AVC. Fully complies with FCC regulations for amateurs. When the monitored station goes off the air, the CA-1 automatically cuts the AC power to your transmitter, and lights a red indicator. A manual "reset" button reactivates the transmitter. Incorporates a heavy-duty six-ampere relay, a thyatron tube to activate the relay, and its own built-in power supply. A neon lamp shows that the alarm is working, by indicating the presence of B+ in the alarm circuit. Simple to install and connect. Your transmitter plugs into an AC receptacle on the CA-1, and a cable connects to the AVC circuit of a nearby receiver. A built-in sensitivity control allows adjustment to various AVC levels. Receiver volume control can be turned up or down, without affecting alarm operation. Build a Heathkit CA-1 in one evening and comply with FCC regulations now! Shpg. Wt. 4 lbs.

MODEL CA-1
\$13⁹⁵

HEATHKIT "Q" MULTIPLIER KIT

The Heathkit Q Multiplier functions with any AM receiver having an IF frequency between 450 and 460 KC, that is not "AC-DC" type. It derives its power from the receiver, and needs only 6.3 volts AC at 300 ma (or 12 VAC at 150 ma) and 150 to 250 volts DC at 2 ma. Simple to connect with cable and plugs supplied. Adds additional selectivity for separating signals, or will reject one signal and eliminate heterodyne. A tremendous help on crowded phone and CW bands. Effective Q of 4000 for sharp "peak" or "null". Tunes any signal within IF band pass without changing the main receiver tuning dial. A convenient tuning knob on the front panel with vernier reduction between the tuning knob and the tuning capacitor gives added flexibility in operation. Uses a 12AX7 tube, and special high-Q shielded coils. Instructions for connecting to the receiver and operation are provided in the construction manual. A worthwhile addition to any communications, or broadcast receiver. It may also be used with a receiver which already has a crystal filter to obtain two simultaneous functions, such as peaking the desired signal with the crystal filter and nulling an adjacent signal with the Q Multiplier. Shpg. Wt. 3 lbs.

MODEL QF-1
\$9⁹⁵

HEATHKIT GRID DIP METER KIT

A grid dip meter is basically an RF oscillator for determining the frequency of other oscillators, or of tuned circuits. Extremely useful in locating parasitics, neutralizing, identifying harmonics, coil winding, etc. Features continuous frequency coverage from 2 mc to 250 mc, with a complete set of prewound coils, and a 500 ua panel meter. Front panel has a sensitivity control for the meter, and a phone jack for listening to the "zero-beat." Will also double as an absorption-type wave meter. Shpg. Wt. 4 lbs.

MODEL GD-1B

Low Frequency Coil Kit: Two extra plug-in coils to extend frequency coverage down to 350 kc. Shpg. Wt. 1 lb. No. 341-A. \$3.00

\$21⁹⁵

HEATHKIT ALL-BAND COMMUNICATIONS-TYPE RECEIVER KIT

This communications-receiver covers 550 kc to 30 mc in four bands, and provides good sensitivity, selectivity, and fine image rejection. Ham bands are clearly marked on an illuminated dial scale. Features a transformer-type power supply—electrical band spread—antenna trimmer—head-phone jack—automatic gain control and beat frequency oscillator. Accessory sockets are provided on the rear of the chassis for using the Heathkit model QF-1, Q Multiplier. Accessory socket is handy, also, for operating other devices that require plate and filament potentials. Will supply +250 VDC at 15 ma and 12.6 VAC at 300 ma. Ideal for the beginning ham or short wave listener. Shpg. Wt. 12 lbs.

MODEL AR-3

\$29⁹⁵

Cabinet: Fabric covered cabinet with aluminum panel as shown. Part no. 91-15A. Shpg. Wt. 5 lbs. \$4.95.

(Less cabinet)

Heathkits...

BY DAYSTROM

*are outstanding in performance
and dollar value*

RADIO & TV NEWS

HEATHKIT REFLECTED POWER METER KIT

The Heathkit reflected power meter, model AM-2, makes an excellent instrument for checking the match of the antenna transmission system, by measuring the forward and reflected power or standing wave ratio. The AM-2 is designed to handle a peak power of well over 1 kilowatt of energy and may be left in the antenna system feed line at all times. Band coverage is 160 meters through 2 meters. Input and output impedances for 50 or 75 ohm lines. No external power required for operation. Meter indicates percentage forward and reflected power, and standing wave ratio from 1:1 to 6:1. Another application for the AM-2 is matching impedances between exciters or R.F. sources and grounded grid amplifiers. Power losses between transmitter output and antenna tuner may be very easily computed by inserting the AM-2 in the line connecting the two. No insertion loss is introduced into the feeder system, due to the fact that the AM-2 is a portion of coaxial line in series with the feeder system and no internal connections are actually made to the line. Complete circuit description and operation instructions are provided in the manual. Cabinet size is 7-3/8" x 4-1/16" x 4-5/8". Can be conveniently located at operating position. Shpg. Wt. 3 lbs.

MODEL AM-2

\$15⁹⁵

HEATHKIT VARIABLE FREQUENCY OSCILLATOR KIT

Enjoy the convenience and flexibility of VFO operation by obtaining the Heathkit model VF-1 Variable Frequency Oscillator. Covers 160-80-40-20-15-11 and 10 meters with three basic oscillator frequencies. Better than 10 volt average RF output on fundamentals. Plenty of output to drive most modern transmitters. It features voltage regulation for frequency stability. Dial is illuminated for easy reading. Vernier reduction is used between the main tuning knob and the tuning condenser. Requires a power source of only 250 volts DC at 15 to 20 milliamperes and 6.3 volts AC at 0.45 amperes. Extra features include copper-plated chassis, ceramic coil forms, extensive shielding, etc. High quality parts throughout. VFO operation allows you to move out from under interference and select a portion of the band you want to use without having to be tied down to only two or three frequencies through use of crystals. "Zero in" on the other fellow's signal and return his CQ on his own frequency! Crystals are not cheap, and it takes quite a number of them to give anything even approaching comprehensive coverage of all bands. Why hesitate? The model VF-1 with its low price and high quality will add more operating enjoyment to your ham activities. Shpg. Wt. 7 lbs.

MODEL VF-1

\$19⁵⁰

Heathkits...

By DAYSTROM

are the answer for your electronics hobby.

HEATHKIT BALUN COIL KIT

The Heathkit Balun Coil Kit model B-1 is a convenient transmitter accessory, which has the capability of matching unbalanced coax lines, used on most modern transmitters, to balance lines of either 75 or 300 ohms impedance. Design of the bifilar wound balun coils will enable transmitters with unbalanced output to operate into balanced transmission line, such as used with dipoles, folded dipoles, or any balanced antenna system. The balun coil set can be used with transmitters and receivers without adjustment over the frequency range of 80 through 10 meters, and will easily handle power inputs up to 250 watts. Cabinet size is 9" square by 5" deep and it may be located any distance from the transmitter or from the antenna. Completely enclosed for outdoor installation. Shpg. Wt. 4 lbs.

MODEL B-1

\$8⁹⁵

HEATHKIT 6 OR 12 VOLT VIBRATOR POWER SUPPLY KITS

These little power supply kits are ideal for all portable applications with 6 volt or 12 volt batteries, when you are operating electronic equipment away from power lines. By replacing the power supplies of receivers, small public address systems, or even miniature transmitters with these units, they can be used with conventional 6 or 12 volt batteries. Use in boats, automobiles, light aircraft, or any field application. Each unit provides 260 volts DC output at up to 60 milliamperes. More than one power supply of the same model may be connected in parallel for increased current capacity at the same output voltage. Everything is provided in the kit, including a vibrator transformer, a vibrator, 6X4 or 12X4 rectifier, and the necessary buffer capacitor, hash filter, and output filter capacitor. Shpg. Wt. 4 lbs.

6 VOLT
MODEL VP-1-6
12 VOLT
MODEL VP-1-12

\$7⁹⁵ Each

REFLECTED POWER METER

Insure your "on the air" performance with these fine accessories.

VARIABLE FREQUENCY OSCILLATOR

VIBRATOR POWER SUPPLY

BALUN COIL SET

HEATH COMPANY A Subsidiary of Daystrom, Inc. **BENTON HARBOR 15, MICH.**

May, 1958

81

HEATHKIT ELECTRONIC IGNITION ANALYZER KIT

Previous electronic experience is not necessary to build this fine ignition analyzer. The construction manual supplied has complete step-by-step instructions plus large pictorial diagrams showing the exact placement and value of each component. All parts are clearly marked so that they are easily identified. The IA-1 is an ideal tool for engine mechanics, tune-up men, and auto hobbyists, since it traces the dynamic action of voltage in an ignition system on a cathode-ray tube screen. The wave form produced is affected by the condition of the coil, condenser, points, plugs, and ignition wiring, so it can be analyzed, and used as a "sign-post" to ignition system performance. This analyzer will detect inequality of spark intensity, a poor spark plug, defective plug wiring, breaker-point bounce, an open condenser, and allow setting of dwell-time percentage for the points. An important feature of this instrument is its ability to check dynamic performance, with the engine in operation (400 to 5000 RPM). It will show the complete engine cycle, or only one complete cylinder. Can be used on all types of internal combustion engines where breaker-points are accessible. Use it on automobiles, boats, aircraft engines, etc. Shpg. Wt. 18 lbs.

MODEL IA-1
\$59⁹⁵

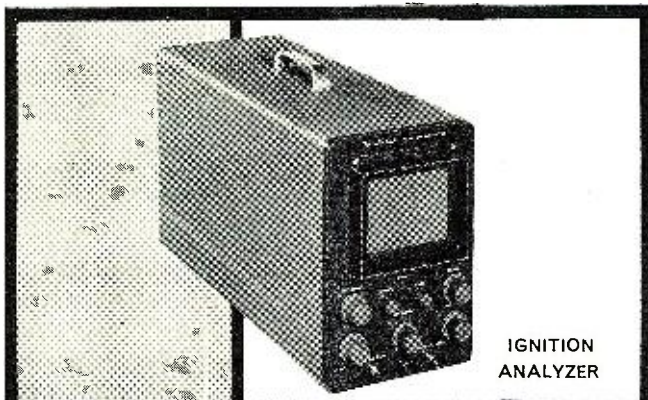

IGNITION ANALYZER



Kit includes everything you need for construction — even batteries!

RADIATION COUNTER



ENLARGER TIMER



BATTERY TESTER

HEATHKIT PROFESSIONAL RADIATION COUNTER KIT

This Heathkit professional-type radiation counter is simple to build successfully, even if you have never built a kit before. Complete step-by-step instructions are combined with giant-size pictorial diagrams for easy assembly. By "building it yourself" you can have a modern-design, professional radiation counter priced far below comparable units. Provides high sensitivity with ranges from 0-100, 600, 6000 and 60,000 counts-per-minute, and 0-.02, .1, 1 and 10 miliroentgens-per-hour. Employs 900-volt bismuth tube in beta/gamma sensitive probe. Probe and 8-foot expandable cable included in kit price, as is a radiation sample for calibration. Use it in medical laboratories, or as a prospecting tool, and for civil defense to detect radioactive fallout, or other unknown radiation levels. Features a selectable time constant. Meter calibrated in CPM or mR/hour in addition to "beep" or "click" from panel-mounted speaker. Prebuilt "packaged" high voltage power supply with reserve capacity above 900 volt level at which it is regulated. Merely changing regulator tube type would allow use of scintillation probe if desired. Employs five tubes (plus a transistor) to insure stable and reliable operation. Kit price includes batteries. Shpg. Wt. 8 lbs.

MODEL RC-1
\$79⁹⁵

Heathkits...

By DAYSTROM

are supplied with comprehensive instructions that eliminate costly mistakes and save valuable time

HEATHKIT ENLARGER TIMER KIT

The ET-1 is an easy-to-build electronic device to be used by amateur or professional photographers in timing enlarger operations. The calibrated dial on the timer covers 0 to 1 minute, calibrated in 5-second gradations. The continuously variable control allows setting of the "on" cycle of your enlarger, which is plugged into a receptacle on the front panel of the ET-1. A "safe light" can also be plugged in so that it is automatically turned "on" when the enlarger is turned "off." Handles up to 350 watts with built-in relay. All-electronic timing cycle insures maximum accuracy. Timer does not have to be reset after each cycle, merely flip lever switch to print, to repeat time cycle. A control is provided for initial calibration. Housed in a compact plastic case that will resist attack of photographic chemicals. A fine addition to any dark room. Shpg. Wt. 3 lbs.

MODEL ET-1
\$11⁵⁰

HEATHKIT BATTERY TESTER KIT

The BT-1 is a special battery testing device that actually "loads" the battery under test (draws current from it) while it is being tested. Weak batteries often test "good" with an ordinary voltmeter but the built-in load resistance of the BT-1 automatically draws enough current from the battery to reveal its true condition. Simple to operate with "good-weak-replace" scale. Tests all kinds of dry cell batteries within ranges of 0-15 volts and 0-180 volts. Slide switch provides for either 10 ma or 100 ma load, depending on whether you're testing an A or B battery. Not only determines when battery is completely exhausted, but makes it possible to anticipate failure by noting weak condition. Ideal for testing dry cell hearing aid, flashlight, portable radio, and model airplane batteries. Test batteries in a way your customers can understand and stimulate battery sales. Shpg. Wt. 2 lbs.

MODEL BT-1
\$8⁵⁰

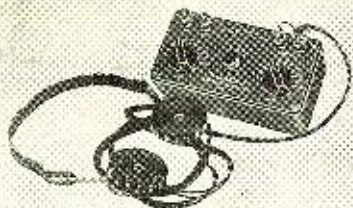

CRYSTAL RADIO



Now you can have radio
wherever you go —
with the portable
that plays anywhere!



BROADCAST BAND RADIO

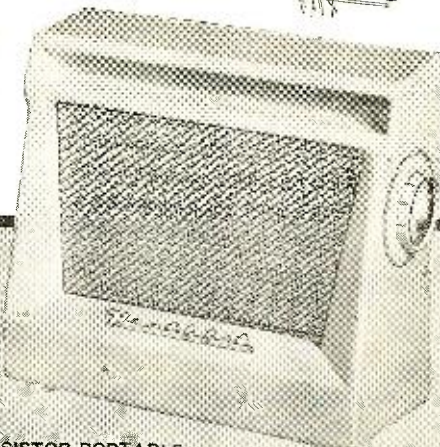

TRANSISTOR PORTABLE

HEATHKIT CRYSTAL RADIO KIT

The Heathkit model CR-1 crystal radio is similar to the "crystal sets" of the early radio days except that it has been improved by the use of sealed germanium diodes and efficient "high-Q" coils. The sealed diodes eliminate the critical "cats whisker" adjustment, and the ferrite coils are much more efficient for greater signal strength. Housed in a compact plastic box, the CR-1 uses two tuned circuits, each with a variable tuning capacitor, to select the local station. It covers the broadcast band from 540 to 1600 kc. Requires no external power whatsoever. This receiver could prove valuable to emergency reception of civil defense signals should there be a power failure. The low kit price even includes headphones. Complete step-by-step instructions and large pictorial diagrams are supplied for easy assembly. The instruction manual also provides the builder with the basic fundamentals of signal reception so that he understands how the crystal receiver functions. An interesting and valuable "do-it-yourself" project for all ages. Shpg. Wt. 3 lbs.

MODEL CR-1
\$7.95

result of these efforts. Six name-brand (Texas Instrument) transistors were selected for extra good sensitivity and selectivity. A 4" by 6" PM speaker with heavy magnet was chosen to insure fine tone quality. The power supply was designed to use six standard size "D" flashlight cells because they are readily available, inexpensive, and because they afford extremely long battery life (between 500 and 1000 hours). Costs you no more to operate from batteries than what you pay for operating a small table-model radio from the power line. An unbreakable molded plastic was selected for cabinet material because of its durability and striking beauty. Circuit is compact and efficient, yet components are not excessively crowded. Transformers are prealigned so it is ready for service as soon as construction is completed. Has built in rod-type antenna for reception in all locations. Cabinet dimensions are 9" L x 8" H x 3 3/4" D. Comes in holiday gray, with gold-anodized metal speaker grille. Compare this portable, feature by feature, to all others on the market, and you'll appreciate what a tremendous dollar value it represents! Shpg. Wt. 4 lbs.

MODEL XR-1
\$34.95
(Less batteries)
(With cabinet)

Heathkits...

By DAYSTROM

*are easy and fun to build,
and they let you learn
by "doing-it-yourself"*

HEATHKIT TRANSISTOR PORTABLE RADIO KIT

Heath engineers set out to develop a "universal" AM radio, suitable for use anywhere. Their objective was a portable that would be as much "at home" inside as it is outside, and would feature top quality components for high performance and long service life. The model XR-1 is the

HEATHKIT BROADCAST BAND RADIO KIT

This table-model broadcast radio is fun to build, and is a fine little receiver for your home. It covers the standard broadcast band from 550 to 1600 kc with good sensitivity and selectivity. The 5 1/2" PM speaker provides surprisingly good tone quality. High-gain IF transformers, miniature tubes, and a rod-type built in antenna, assure good reception in all locations. The power supply is transformer operated, as opposed to many of the economy "AC-DC" types. It's easy to build from the step-by-step instructions, and the construction manual includes information on operational theory, for educational purposes. Your success is assured by completely detailed information which also explains resistor and capacitor color codes, soldering techniques, use of tools, etc. A signal generator is recommended for final alignment. Shpg. Wt. 10 lbs.

Cabinet: Fabric covered cabinet with aluminum panel as shown. Shpg. Wt. 5 lbs. Part no. 91-9A. \$4.95.

MODEL BR-2
\$18.95
(Less cabinet)

HEATH COMPANY A Subsidiary of Daystrom, Inc. **BENTON HARBOR 15, MICH.**
May, 1958

protects against possible explosion and fire from undetected fuel vapor

FUEL VAPOR DETECTOR



detects electrolysis currents which cause deterioration of underwater metal fittings on your boat

ELECTROLYSIS DETECTOR



indicates condition and charge of batteries for safe cruising

BATTERY CHARGE INDICATOR

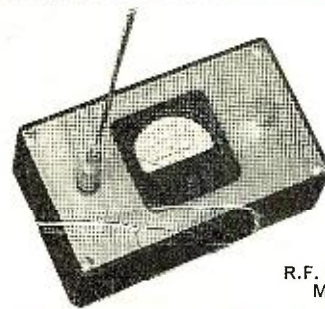

R.F. POWER METER

HEATHKIT FUEL VAPOR DETECTOR KIT

Protect your boat and its passengers against fire or explosion from undetected fuel vapor by building and using one of these fine units. The Heathkit Fuel Vapor Detector indicates the presence of fumes on a three-color "safe-dangerous" meter scale and immediately shows if it is safe to start the engine. A pilot light on the front panel shows when the detector is operating, and it can be left on continuously, or just used intermittently. A panel control enables initial calibration of the detector when installed. Features a hermetically-sealed meter with chrome bezel, and a chrome-plated brass panel. It is very simple to build and install, even by one not having previous experience. Models FD-1-6 (6 volts DC) and FD-1-12 (12 volts DC) operate from your boat batteries. The kit is complete in every detail, even to the inclusion of a spare detector unit. Shpg. Wt. 4 lbs.

6 volt
MODEL FD-1-6
12 volt
MODEL FD-1-12
\$35⁹⁵
EACH

HEATHKIT BATTERY CHARGE INDICATOR KIT

The Heathkit model CI-1 Marine Battery Charge Indicator has been designed especially for the boat owner, although it has found use in service stations, power stations, and radio stations where banks of batteries are kept in reserve for emergency power. It is intended to replace the hydrometer method of checking storage batteries, and to eliminate the necessity for working with acid in small, below-decks enclosures. Now it is possible to check as few as one, or as many as eight storage batteries, merely by turning the switch and watching the meter. A glance at the meter tells you instantly whether your batteries are sufficiently charged for safe cruising. Dimensions are 2-7/8" W x 5-11/16" H x 2" D. Operates on either 6 or 12 volt systems using lead-acid batteries, regardless of size. Simple installation can be accomplished by the boat owner in fifteen minutes. Shpg. Wt. 3 lbs.

MODEL CI-1
\$16⁹⁵

HEATHKIT ELECTROLYSIS DETECTOR KIT

The Heathkit model ED-1 Electrolysis Detector indicates the extent of electrolysis currents between the boat's common ground and underwater fittings, except on boats having metal hulls. These currents, undetected, could

cause gradual corrosion and deterioration of the propeller or other metal fittings below the water line. It is particularly helpful when installing electrical equipment of any kind, or to determine proper polarity when power is obtained from a shore supply. Easy-to-build, the model ED-1 consists of a hermetically-sealed, waterproof meter, special sensing plate, and sufficient wire to install, including the necessary hardware. Mounts on instrument panel where it can be easily seen. Requires no power for operation, and gives instant warning to guard your boat for a lifetime. Shpg. Wt. 2 lbs.

MODEL ED-1
\$9⁹⁵

HEATHKIT RF POWER METER KIT

The Heathkit RF Power Meter Kit is designed to sample the RF field in the vicinity of your transmitter, whether it be marine, mobile, or fixed. Output meter is merely placed in some location close to the transmitter, to pick up RF radiation from the antenna. Requires no batteries, electricity, nor direct connection to the transmitter. It provides you with a continuing indication of transmitter operation. You can easily detect if power is dropping off by comparing present meter readings with past ones. Operates with any transmitter having output frequencies between 100 kc and 250 mc, regardless of power. Sensitivity is 0.3 volts RMS full scale, and a special control on the panel allows for further adjustment of the sensitivity. Meter is a 200 ua unit, mounted on a chrome-plated brass panel. The entire PM-1 measures only 3 3/4" W x 6 1/4" L x 2" D. An easy way to put your mind at ease concerning transmitter operation. Shpg. Wt. 2 lbs.

MODEL PM-1
\$14⁹⁵

Heathkits...

By DAYSTROM

now offer you completely modern marine equipment with outstanding design features

for

17 WATTS PUSH-PULL POWER at 300 V. B +

with a pair of
MINIATURE tubes



the

Amperex® EL84/6BQ5

LOW-DISTORTION,
HIGH-GAIN POWER PENTODE

- True pentode characteristics for low distortion and high peak power.
- High gain and sensitivity resulting in reduced driver stage distortion.
- 12 watts plate dissipation in a miniature envelope.
- At 300 volts, capable of 17 watts at 4% distortion (without feedback) in Class AB push-pull pairs.
- 5.7 watts output at 10% harmonic distortion (without feedback) as a single-ended output stage.

OTHER **Amperex TUBES** FOR
HIGH-FIDELITY AUDIO APPLICATIONS:

- 6CA7/EL34** High-power pentode; 100 W PP
- EF86/6267** Low-noise high- μ pentode
- ECC81/12AT7** Low-noise medium- μ dual triode
- ECC82/12AU7** Low-noise low- μ dual triode
- ECC83/12AX7** Low-noise high- μ dual triode
- ECC85/6AQ8** High- μ dual triode for FM tuners
- GZ34/5AR4** Cathode-type rectifier; 250 ma.
- EZ80/6V4** 9-pin rectifier; cathode; 90 ma.
- EZ81/6CA4** 9-pin rectifier; cathode; 150 ma.

At All Leading Electronic
Parts Distributors

Amperex
ELECTRONIC CORP.
230 Duffy Ave., Hicksville, Long Island, N.Y.



Hi-Fi-Audio



Product Review

MILLER FM TUNER

J. W. Miller Company, 5917 S. Main St., Los Angeles 3, Calif. is now offering a moderately priced and compact FM tuner as its #560.

The new tuner is self-powered, completely shielded and has flywheel tuning, built-in antenna for local reception, edge-lighted dial, tuning indicator, and carries UL approval.

Sensitivity is 3 microvolts for 20 db quieting. Frequency response is \pm

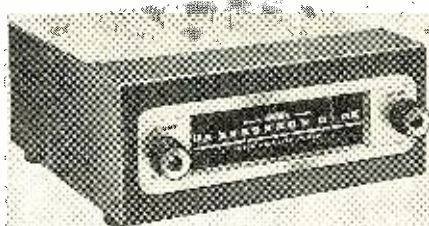

5% from 20 to 20,000 cps. The circuit has negligible drift with the a.f.c. and meets FCC specifications on radiation.

The tuner is housed in an attractive cabinet which measures 10" wide, 4 1/4" high, and 7 1/2" deep. The six-tube circuit consumes 35 watts.

BATTERY STEREO RECORDER

Amplifier Corp. of America, 398 Broadway, New York 13, N. Y. has developed a new self-contained stereophonic tape recorder for field use.

With this lightweight, small-size yet professional unit, motion picture pro-



ducers, sound engineers, and stereo enthusiasts are enabled to experiment with and produce stereophonic recordings.

Three single-speed models are available: 3.75, 7.5, or 15 ips. Models at 15 ips meet primary NARTB standards while those employing 7.5 ips meet secondary NARTB standards. Measuring 8 1/2"x11"x10", the "Stereo-Magmite" weighs only 17 pounds.

The high gain recording-playback

amplifiers are powered by inexpensive dry-cell flashlight batteries and one "B" battery which last 100 operating hours. Constant tape speed over the full winding cycle is achieved by means of a centrifugal ball-bearinged, triple-compensated flyball governor on the spring motor.

Complete technical specifications and prices are available from the manufacturer on request.

STEREO PREAMP-CONTROL UNIT

Pilot Radio Corporation, Long Island City 1, N. Y. has added a stereo preamplifier-audio control, the Model SP-215, to its line of hi-fi components.

The new unit is a professional type, bi-channel preamplifier, housed in a brushed brass and burgundy metal enclosure with inputs for stereo FM-AM broadcasts, stereo tapes, stereo discs, microphones, and other stereo signal sources. It has a separate output for recording stereo tapes, two vu meters, and controls for setting reference and peak recording levels.

Other features include bass and treble controls, volume and loudness controls, and a balance control for

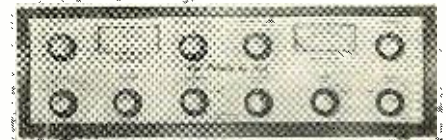

equalizing the level between the channels. The SP-215 can be used with two power amplifiers as the basis of any stereo sound system.

Dimensions of the unit are 4 3/4" x 14 1/16" x 10 5/32". Write the manufacturer direct for additional details and price.

"UNI-FI" TUNER-AMPLIFIER

Allied Radio Corporation, 100 N. Western Ave., Chicago 80, Ill. has added a tuner-amplifier combination to its "Knight" line of audio equipment.

The "Uni-Fi" combines an FM-AM tuner and a complete 15-watt amplifier on a single chassis. Since the unit is equipped with a preamp and has a full set of controls, it is only necessary to add a record changer and speaker for a complete hi-fi set-up.

The built-in amplifier employs two EL84's in the output stage and delivers a full 15 watts. A switching circuit converts the conventional volume control of the "Uni-Fi" to a loudness control to permit full-range sound even at low listening levels.

Also included are rumble and scratch filters, separate bass and treble controls, three-position record

NORELCO[®]

presents
the world's

second finest*

pickup
cartridge

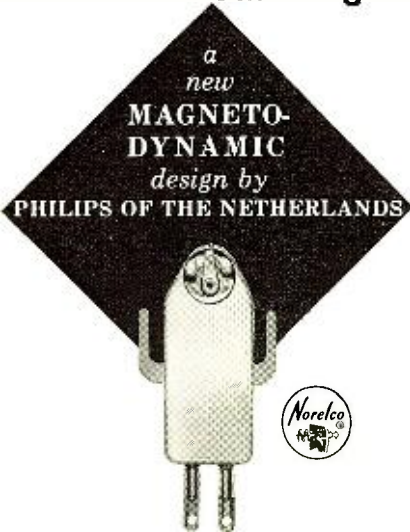

*The world's finest pickup cartridge is carefully guarded at the great Philips audio research center in Eindhoven, the Netherlands. It is the laboratory prototype of the new NORELCO "Magneto-Dynamic" pickup cartridges—a special pilot model hand-built to zero tolerances by Europe's most renowned electro-acoustic research team. This reference standard must, of necessity, be a shade superior to the production models, which are constantly quality-controlled against it. It is an indispensable laboratory tool that obviously cannot be sold. But the world's second finest pickup cartridge—meaning any and every NORELCO production model—can be and is sold by leading hi-fi outlets everywhere, for the astonishing price of \$29.95, with diamond stylus.

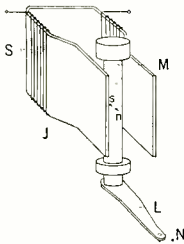

THE MAGNETO-DYNAMIC PRINCIPLE—Armature M, made of high-coercivity ferrite, is magnetized perpendicularly to its axis (s—n) and is rotated about the axis by the transverse vibrations of stylus bar L, which is driven by the 1-mil diamond stylus N. This rotation induces a varying flux in the core J, which results in the development of a corresponding AC voltage in the coil S. Advantages of the system include very high compliance (more than 5×10^{-6} cm/dyne), very low dynamic mass (2.8 milligrams), high output (35 millivolts at 10 cm/sec), low stylus force (5 grams), and vanishingly low distortion. Frequency response is flat within 2 db from 10 to 20,000 cps.

NORTH AMERICAN PHILIPS CO., INC.
High Fidelity Products Division, Dept. RNC2
230 Duffy Avenue, Hicksville, L. I., N. Y.

compensator, and a three-position selector switch which lets the user play music through either of two speaker systems or both simultaneously. Output terminals match 4, 8,

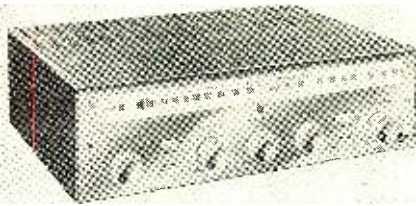

or 16-ohm speakers and a high-impedance output jack permits convenient tape recording of FM or AM programs.

The company will supply full details on this new unit upon request.

BATTERY/TRANSISTOR RECORDER

Filnor Products, Inc., 101 West 31st Street, New York 1, N. Y. is now offering a fully transistorized, battery operated, portable tape recorder which is being imported from West Germany and marketed as the "Tel Tape."

Weighing less than two pounds and measuring only $8\frac{1}{2}'' \times 6\frac{1}{2}'' \times 2\frac{1}{2}''$, the unit will operate on only four ordinary

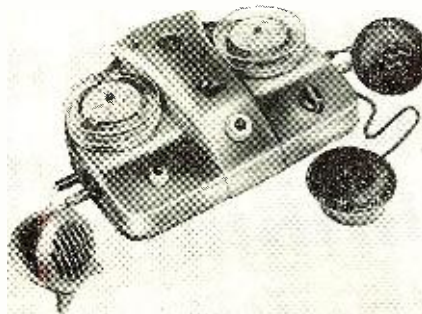

penlite batteries. It records speech and song for use at home and for student study. The unit records, plays back, and erases and even incorporates variable speed controls. The unit comes complete with earphones and microphone.

Dept. P202 of the importer will supply full details plus price information and delivery dates on request.

CHANGER-MANUAL PLAYER

Garrard Sales Corp., 80 Shore Road, Port Washington, N. Y. has announced that its RC121 changer has been replaced by a dual-purpose record player which converts instantly from an automatic intermix changer to a single play unit with the tone arm completely free. The new model is the RC121/II.

The new unit is especially adaptable to replacement or service technician applications since it will fit into virtually any cabinet area designed for a record changer.

In addition to the features incorporated in the previous model, the unit has a new unitized control for automatic and full manual operation. In the automatic mode, the changer will handle 12" and 10" records intermixed in any order. An exclusive new spindle

OSCILLOSCOPE COURTESY OF
PRECISION APPARATUS COMPANY, INC.

I used to
WATCH
the music
on the
oscilloscope...



... but a
NORELCO[®]
speaker
made me

LISTEN!



Every time I bought a record, I used to set up the calibrated microphone, connect the oscilloscope, start the music with bated breath, and keep my eyes glued to the screen. If anything on the scope pattern looked suspicious (something always did), I would start checking tubes, voltages and crossover frequencies, and examine the record under a microscope.

Then, at the house of a musician friend, I heard a NORELCO loudspeaker. I was suddenly carried away by the sheer joy of listening! What lovely sound! Clean, tight bass; creamy smooth highs; crisply defined middles... it was music!

I rushed out to the nearest hi-fi dealer, bought my own NORELCO speaker, took it right home... and I am a different person today. Man, just listen to that music!

(You can change your hi-fi life, too—just write to North American Philips Co., Inc., High Fidelity Products Division, 230 Duffy Avenue, Hicksville, Long Island, N. Y.)

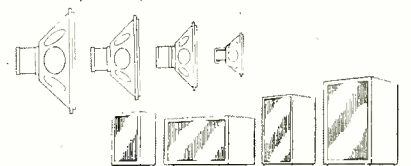

a complete line of 5" to 12" high-fidelity speakers and acoustically engineered enclosures

THIS IS THE WAY
A GREAT
TAPE
RECORDER
IS BUILT...

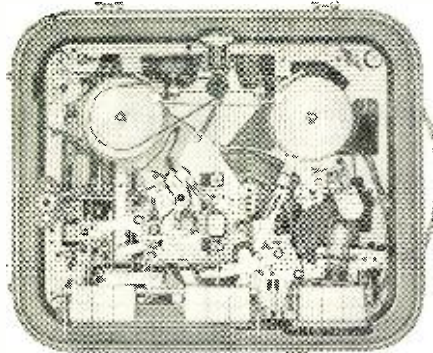

the
new
imported

NORELCO[®]

'CONTINENTAL'

world's
most advanced
all-in-one
portable

**TAPE
RECORDER**

Engineered by Philips of the Netherlands, world pioneers in electronics
Precision-crafted by Dutch master technicians
Styled by the Continent's top designers
Three speeds (7½, 3¾ and 1½ ips)...
twin tracks...pushbutton controlled
Special narrow-gap (0.0002 in.) head
for extended frequency response
Built-in wide-range Norelco speaker
Also plays through external hi-fi set

For the name
and address
of your nearest
Norelco dealer,
write to Dept. 510



NORTH AMERICAN PHILIPS CO., INC.
High Fidelity Products Division
230 DUFFY AVENUE, HICKSVILLE, L.I., N. Y.

positively prevents double record drop and affords extra protection against center hole wear.

There is a special stop/pause feature control that interrupts performance

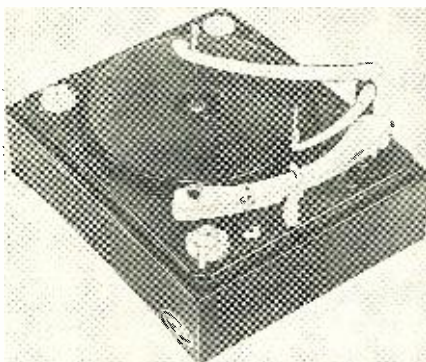

at any point and permits it to be started again without losing groove position; or the record can be rejected at the user's option.

Department K38 of the company will supply full details on request.

NEW SHURE CARTRIDGE

Shure Brothers, Inc., 222 Hartney Ave., Evanston, Ill. has developed a new high-fidelity phonograph cartridge which employs a unique moving magnet principle for superior response and elimination of hum and "needle talk."

Known as the "Professional Dynetic," the new cartridge is designed for use in record changers and transcription tone arms. Its tracking force

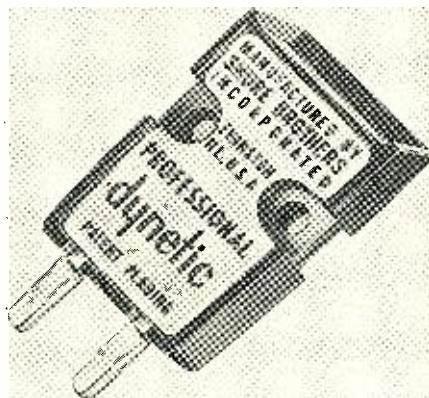

is 3 to 6 grams. Response is flat from 20 to 20,000 cps. Since the magnet turns on a vertical axis, the needle tip is placed at the end of a light metallic beam, providing very low needle point mass. The new cartridge can be used with any amplifier having a magnetic phono input.

The "Professional Dynetic" comes with a 1 mil diamond needle for LP's and a 2.7 mil sapphire needle for 78 rpm records.

SCOTT 36-WATT AMPLIFIER

H. H. Scott, Inc., 111 Powdermill Road, Maynard, Mass, has added a 36-watt amplifier to its 210 high-fidelity component series and designated it as the Model 210-F.

The amplifier has the company's new dynamic noise suppressor including separate controls for low-frequen-

cy and high-frequency noise suppression. This development suppresses rumble from old changers and noise from worn records without blocking music.

The front panel includes a record compensator and selector, relative bass and treble loudness selectors, a volume selector, three-position speaker selector, and pickup selector. The 210-F contains complete tape recording facilities—an instantaneous monitoring switch and a NARTB tape playback channel for recorded tape. There are two special tape output connections on the rear.

In the optional mahogany case, the amplifier measures 15½" x 5" x 12". The company will supply a free bulletin on the Model 210-F upon written request to Department P.

GROMMES STEREO PREAMP

The Grommes High Fidelity Division of Precision Electronics, Inc., 9101

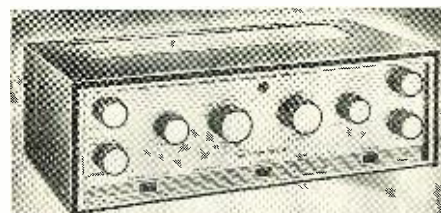

King St., Franklin Park, Ill. has just introduced a new stereo preamplifier, the Model 208.

Designed to work with two high-quality basic power amplifiers, the Model 208 unifies and controls the separate components of a stereo system. It will handle stereo program material from any source, including FM-AM tuner, tape, phono pickup, etc.

The circuit consists of two independent channels for each of the five inputs with ganged selector, turnover, roll-off, volume, bass and treble controls. A function switch is included to enable either channel A or B to be used as a monaural preamp driving both power amplifiers when no stereophonic program source is available.

The preamp is self-powered with d.c. on the filaments to make it especially suited for operation direct from tape heads. There is variable equalization on both channels for stereo records.

For complete specifications on the Model 206, write the manufacturer direct.

SENSITIVE FLUTTER METER

Amplifier Corp. of America, 398 Broadway, New York 13, N. Y. has developed a sensitive measuring device which meets the standards set by the SMPTE for flutter and wow.

The new instrument is designed to fill the need for a sensitive, rapid, and accurate method of visual indication of wow and flutter content of all types of tape recorders and playback equipment including 33½, 45, and 78 rpm discs and 16 and 35 mm. sound mechanisms.

A built-in 3000 cps oscillator is in-

corporated for recording purposes. This permits the flutter meter to be used as a complete instrument in itself and eliminates the necessity for calibrating and using external oscillators. A three-range filter is included

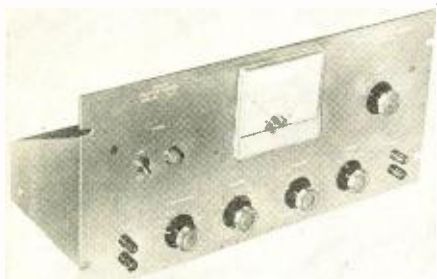

to study and isolate flutter and wow components. These ranges are .5 to 6 cps for wow, 5 to 250 cps for flutter, and the combined flutter and wow of .5 to 250 cps.

Complete technical specifications and direct factory prices may be obtained by writing the Instrument Division of the company.

E-V STEREO CARTRIDGE

Electro-Voice, Inc. of Buchanan, Mich. is in production on a stereo phono cartridge which will retail in the moderate price class.

The Model 21D provides a frequency response of 20 to 16,000 cps \pm 2.5 db to RIAA and a .5 volt r.m.s. output in accordance with the *Westrex* 1A requirements. Compliance is 2×10^{-4} cm/dyne and tracking force is 6 grams. The stylus is .7 mil and the unit weighs 2.4 grams. It will mount on standard $\frac{1}{2}$ " and $\frac{7}{16}$ " tone-arm centers.

The cartridge uses a single stylus and two ceramic elements. For the replacement market, the cartridge will be equipped with a diamond needle. According to the company, this new cartridge can be used to play conventional LP's as well as the stereo discs.

AUDIO CATALOGUES

SPEAKER EXPANSION SYSTEMS

University Loudspeakers, Inc. 80 S. Kensico Ave., White Plains, N. Y. announces the availability of a new brochure covering its progressive speaker expansion plan.

With the aid of charts, the PSE plan is concisely presented. The audiophile is shown how to choose his basic speaker or speaker system from a wide selection of available speakers and network components and then guided through a progression of steps that would enable him to add components until he achieves his "dream" system without discarding any of the original items.

OXFORD COMPONENT LINE

Oxford Components, Inc., 556 W. Monroe St., Chicago 6, Ill. has just released a colorful 12-page catalogue which provides complete information on its line of speakers including those in the PM replacement line; for p.a.

May, 1958

Now... for high-fidelity magnetic recording!



...on "load-easy" reels for fast tape-threading!

Here's good news for users of magnetic tape for high-fidelity sound recording! RCA now makes available a wide selection of *Sound Tape* on popular-size 5" and 7" reels, on splice-free Mylar* or acetate bases. You'll be delighted with the "Load-Easy" reels which simplify recording, make tape-threading as simple as A B C. *RCA Sound Tapes* give you clear, crisp recordings, faithful to the original sound—the best playbacks possible from your recorder. Use these accessories too: Tape Storage Chest, Splicer, Empty "Load-Easy" Reels!

Now available wherever superior-quality tape is sold!



RADIO CORPORATION OF AMERICA
Electron Tube Division

Harrison, N. J.

*Du Pont Reg. TM

Some facts on the measure of the

JansZen loudspeaker

One very important measure of a loudspeaker's capability as a true high fidelity component lies in its ability to reproduce music with the same emphasis at all volume levels. As the volume control is turned from maximum to minimum, each instrument of an orchestra should remain in the same perspective . . . the effect being of walking farther and farther away from a live orchestra as it is playing.

When a response curve is taken on a JansZen speaker from the lowest listening level up to a full 50 watts of power, the resultant curves are absolutely identical.

This is a true measure of smooth response, which in turn is a measure of the similarity between what goes into a recording microphone compared with what comes out of your speaker at home. Hence, it is a measure of whether a high fidelity speaker is in fact what it is supposed to be.

A response curve is taken on every JansZen speaker before it leaves the factory. Only in that way can it be assured that each speaker is right. Only in that way can it be assured that all speakers are exactly the same. That's why most knowledgeable listeners consider JansZen as The Speaker.

*DESIGNED BY ARTHUR A. JANSZEN

Write for literature and the name of your nearest dealer

Product of **NESHAMINY ELECTRONIC CORP.**, Neshaminy, Pa.

Export Division: 25 Warren Street, N.Y.C. 7, Cable Simonrice, N.Y.

HERE'S HOW
TO HAVE A

HIGH AND STEADY

Income...

Wherever you go, look for the fixed and mobile antennas of commercial and public-safety 2-way radios. These equipments must have periodic, competent maintenance—which means regular income to qualified servicemen. Much of this work is done by *independent* shops on a term-contract basis.

To learn about rates . . . typical contracts . . . and take-home pay . . . send for free booklet "HOW TO MAKE MONEY IN MOBILE-RADIO MAINTENANCE."

MAIL COUPON
TODAY!

LAMPKIN LABORATORIES, INC.
MFM Division, Bradenton, Florida

At no obligation, please send me free booklet, technical data on Lampkin meters, and time-payment plan details.

Name _____

Address _____

City _____ State _____

Your present test equipment and these two Lampkin meters—plus 2nd class commercial license—are sufficient to get started.

Lampkin 105-B Frequency Meter.
Range 0.1 to 175 MC
and up. Price
\$220.00 net.



Lampkin 205-A FM
Modulation Meter.
Range 25 to 500 MC.
Price \$240.00 net.

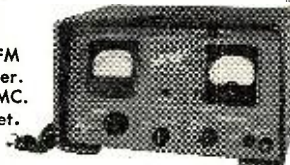

TIME PAYMENT PLAN AVAILABLE

LAMPKIN LABORATORIES, INC.

MFM Division
BRADENTON, FLORIDA

applications; intercom, weatherproof, hi-fi, extended range, full range, coaxial, rear seat, TV, radio and special type speakers.

The catalogue gives complete specs and each speaker type is illustrated.

ARKAY HI-FI CATALOGUE

Arkay, 120 Cedar Street, New York, N.Y. has announced the availability of its 1958 catalogue covering audio, TV, high-fidelity, and stereophonic components in factory wired and kit form.

The publication provides complete descriptions, specifications, and prices. The catalogue is available without charge on request.

FISHER RADIO-PHONO DATA

Fisher Radio Corporation, 21-21 44th Drive, Long Island City 1, N. Y. is offering copies of its new radio-phonograph brochure without charge to interested persons.

The new publication contains complete information about the company's high-fidelity consoles and includes electrical as well as mechanical specifications. Those wishing a copy of the 8½" x 11" brochure should write the manufacturer direct.

-30-

Sun	Mon	Tue	Wed	Thu	Fri	Sat
			2	3	4	5
						12
						19
						26

CALENDAR of EVENTS

MAY 2

Fifth Annual Conference for Engineers and Architects. Sponsored by Ohio State College of Engineering, Columbus, Ohio. Program and preregistration information available from Assoc. Dean Harold A. Bolz, chairman of Conference.

MAY 5, 6, 7

PGMTT National Symposium. Sponsored by IRE and PGMTT. Stanford University. Program information from Dr. K. Tomiyasu, G-E Microwave Lab., 601 California Ave., Palo Alto.

MAY 9

Eighth Annual Radio-Television Industry Conference and Banquet. Radio-Television Center, San Francisco State College. For further information contact Jack Sampson in care of the College at 1600 Holloway Ave., San Francisco 27, Calif.

MAY 13, 14, 15

Spring Assembly Meeting of Radio Technical Commission for Marine Services. Sponsored by FCC. Benjamin Franklin Hotel, Philadelphia.

MAY 19, 20, 21

1958 Electronic Parts Distributors Show. Conrad Hilton Hotel, Chicago. General Manager, Kenneth C. Prince, 11 S. La Salle St., Chicago 3, Ill.

MAY 27, 28

Second EIA Conference on Maintainability of Electronic Equipment. University of Pennsylvania, Philadelphia, Pa. Contact EIA Engineering Dept., 11 W. 42nd St., New York 36, N. Y., for program details.

**"50%-70% OF MISSILES
ARE ELECTRONIC PARTS"**

The Future is Wide Open in GUIDED MISSILE ELECTRONICS!

when you acquire high-level training in
ELECTRONIC ENGINEERING TECHNOLOGY

CREI prepares you
quickly for success in

GUIDED MISSILES RADAR
INSTRUMENTATION AUTOMATION
SERVOMECHANISMS TELEMETERING
COMPUTERS ELECTRONICS MANUFACTURING
AERONAUTICAL ELECTRONICS
COMMUNICATIONS ASTRONAUTICS

The Future then is in your hands...
Send now for CREI's **NEW FREE BOOKLET**



Crammed with facts and data—containing a time-proved plan to make you ready for the big jobs and high-salaried careers now being offered in America's fastest growing industry. Mail coupon today, or write: Capitol Radio Engineering Institute, Dept. 115-R, 3224 - 16th St., N.W., Washington 10, D. C.



MAIL TODAY FOR YOUR FREE BOOKLET

CAPITOL RADIO ENGINEERING INSTITUTE
ECPD Accredited Technical Institute Curricula—Founded 1927
Dept. 115-R, 3224 Sixteenth St., N. W., Washington 10, D. C.
Please send me your course outline and FREE illustrated Booklet, "Your Future in the New World of Electronics" . . . describing opportunities and CREI Home Study courses in Practical Electronic Engineering Technology.

CHECK Radar, Servo and Computer Engineering Technology
FIELD OF Electronic Engineering Technology
GREATEST Broadcast (AM, FM, TV) Engineering Technology
INTEREST Television Engineering Technology
 Aeronautical Electronic Engineering Technology **M**

Name..... Age.....

Street

City Zone..... State.....

Check: Home Study Residence School Korean Veteran

NOT FOR BEGINNERS: If you have the equivalent of a high school education, and are good at mathematics, if you have some electronics experience (advanced amateur, experimenting, military or industrial)—you can qualify for CREI home study training. (Electronic experience is not required for admission to CREI Residence School.) Please fill in following information:

Employed By.....

Type of Present Work.....

Education:

Yrs. High School.....

Yrs. College.....

Electronics Experience.....

TELLS how you can make a secure, lifetime career in the tremendously expanding field of electronics.

TELLS what employers demand of YOU in technical knowledge.

TELLS what and where the opportunities are—what they pay—the security and other benefits when you qualify.

TELLS how you can qualify for top-pay jobs in Radar, Guided Missiles, Servos, Computers, Aeronautical Electronics, Electronic Manufacturing, Communications.

TELLS how we can help YOU become a leader in your profession, in minimum time.

By JOHN M. DOYLE

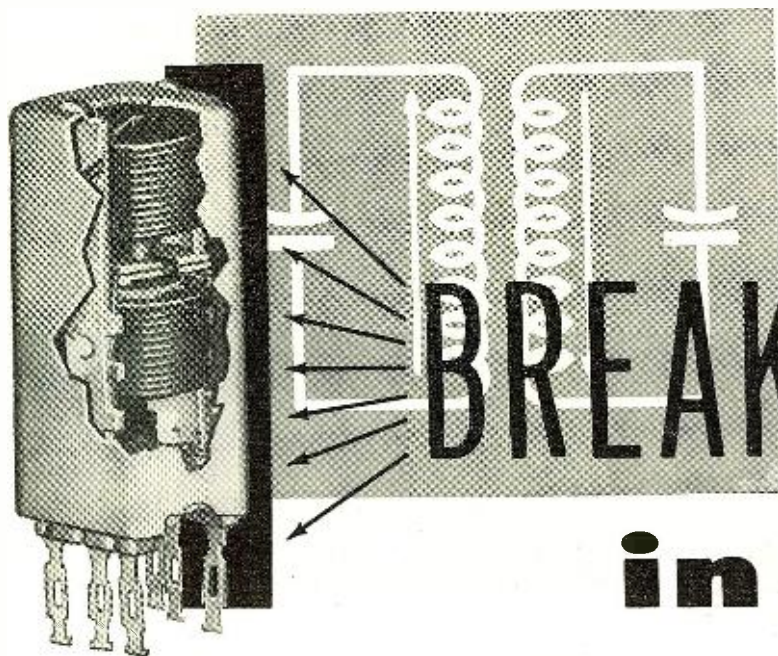

BREAKDOWNS in AM F. Transformers

The popular slug-tuned miniature i.f. transformers have characteristic patterns of fault development.

BREAKDOWN of i.f. transformers in radio receivers employing miniature types occur frequently enough to justify special, rapid analysis and repair techniques.

Normal complaints for this type of difficulty are: (1) no sound, although all tubes are lit; (2) rapid fluctuations in volume accompanied by a "popping" sound; or, (3) loss of sensitivity, along with noise similar to the rustling of paper. Refer to Fig. 1 which shows that portion of the circuit in a typical AM receiver with which we are concerned.

Our first objective is to isolate the trouble to a specific portion of the receiver. If the first symptom is present, we can eliminate the audio stages from consideration by touching the grid of the first audio amplifier at the center tap of the volume control. The resulting amplified noise voltage (60 cps) will be heard at the loudspeaker, exonerating the audio stage. For the second and third symptoms, we know by the nature of the defect that the audio section is operating. The tests to be described herein serve to localize the difficulty more closely, for they have one effect in common—abnormal a.v.c. voltages.

Irrespective of which symptom is evident, our first measurement is made by connecting a v.t.v.m. to either point A or B in Fig. 1. In the case of a dead receiver, point A is preferred. The meter may give an in-

dication of up to +4 volts, rather than the slightly negative normal contact bias obtained at an idling detector of approximately -6 volt. If the reading is positive by any amount, the logical procedure is to determine whether the tube or the coil is defective. A gassy detector, for instance, would develop a positive voltage due to the flow of reverse current. Clip the meter lead to point A and pull the de-

EDITOR'S NOTE: *If you look at nothing but the schematic, the AM i.f. strip has not changed in decades. If you look at the sets themselves, however, things—especially i.f. cans—are not what they used to be years ago.*

tor tube. If upon doing so the positive voltage disappears, the tube is at fault. If, on the other hand, the *output* i.f. transformer is the cause of the trouble, the plus reading will increase and may reach as high as 90 volts in an a.c.-d.c. receiver.

With the vast majority of small receivers being of the a.c.-d.c. type employing series-string heaters, the described procedure may seem somewhat confusing, for in pulling any tube we are effectively "shutting off" the set. However, it must be remembered that, for a brief period of time (an average of approximately 20 seconds), the cathodes of those tubes remaining in place are still hot enough to emit a considerable volume of electrons. The decay of "B+" will fol-

low an exponential curve during cooling and will not be instantaneous. Conditions will therefore remain stable long enough to permit a reliable check.

In those cases where one-volt tubes are employed (a.c.-d.c.-battery sets), the reader is cautioned not to pull and replace tubes while the receiver is turned on. The filament-circuit electrolytics employed will charge to a high voltage when the string is opened with the set in operation. If, as is customary, the tube is plugged back in as soon as the meter reading is observed, the resultant capacitor discharge surge could knock out every tube in the set. Therefore the receiver must be turned off and a tube checker employed in such cases. For testing the transformers, the resistance-measurement method is used. This technique is fully described later.

Returning to test point A in the dead receiver, when normal negative contact bias is indicated, transfer the hot lead of the v.t.v.m. to point B. If a small positive voltage is now noted here, clip the meter lead to point B and pull the i.f. amplifier tube. Should the positive voltage disappear, the tube is gassy or otherwise defective. When the positive reading remains and does not change appreciably, the converter tube is also pulled. The reasoning already noted with respect to the condition of the tube is applied. (It is of interest to note that a gassy tube will seldom give a positive reading greater than 2 volts.) When the positive reading increases as the tubes are pulled, the *input* i.f. transformer is breaking down.

We will next discuss the case of a receiver exhibiting the second symptom; *i.e.*, rapid fluctuations in volume accompanied by a popping sound. With a local station tuned in, some value of a.v.c. voltage (assume -4 volts) will be generated by the detector. Connect the meter to point A. Two different types of meter fluctuation may be observed at this point, depending on which transformer is defective. If the meter tends to fluctuate in a negative direction, the *input* transformer is faulty. The presence of "B+" leakage across this transformer removes part of the bias normally developed by a.v.c. action. This causes the tube to amplify more than normal, with a greater output resulting at the detector.

A positive check is to clip the meter lead to point B and remove the tubes in the same manner as previously described for a dead receiver. The voltage at point B is usually considerably less than at point A when this defect is present. If the meter fluctuates in a positive direction (from negative toward zero), the output transformer is defective.

With a rectified voltage of -4 volts, the intermittent "B+" leakage will be cancelling part of this negative voltage, but only for the duration of the leakage burst. Since the grid of the i.f. amplifier is fed by a relatively slow-acting RC filter (in the a.v.c. line), it does not have an opportunity to follow the rapid shifts in voltage that occur at the diode during the "B+" flashover. Therefore, the stage gain of the i.f. amplifier will be almost constant and the rectified current of the detector is mostly dependent upon arriving signal strength. Thus, the leakage of "B+" will only result in the popping noise heard at the loudspeaker, and will not cause an increase in over-all signal delivered to the detector.

The final symptom is loss of sensitivity and noise similar to the rustling of paper. Again, tests on the a.v.c. system are employed to locate the trouble. With the set tuned to a distant station (when possible) or to no station at all, a positive voltage of approximately .1 to .5 volt will be noted at either point A or B. Tests for defective tubes are carried out as previously described. The breakdown in one of the transformers, when it is the factor here, is due to a combination of the defects noted for the first two symptoms. While we have a steady leakage current, as with a dead receiver, it is very much lower and does not paralyze the tubes. We also have a form of flashover that is much steadier than the type which produced the popping sound for the second symptom. Here, again, the tube which gives the highest positive indication when pulled, is located in the output circuit of the defective transformer.

Final proof of breakdown can be obtained for any of the noted symptoms by the resistance method previously mentioned. Turn the receiver off, disconnect the a.v.c. lead from the secondary of the suspected transformer, and connect the v.t.v.m. in its place. Next, connect an external power supply of 100 volts as shown in Fig. 2. If the receiver is of the a.c.-d.c. type and employs a metallic rectifier, the external power supply is not required. Merely pull one of the tubes, which breaks the heater string and leaves only the "B+" for your convenience.

When power is applied to the circuit just set up, the voltage reading on the meter will tell whether there is any breakdown (leakage) between the windings of the i.f. transformer. An examination of Fig. 3, which is a simplified equivalent of Fig. 2, shows what happens. Whatever leakage resistance exists in the transformer is placed in

series with the resistance of the meter.

With the circuit completed by the leakage path, there will be some voltage drop across the input resistance of the meter, with the rest of the source voltage being dropped across the leakage resistance in the transformer, which will generally be much higher. If we know how much voltage is dropped across the meter (indicated by its reading), we also know that the remainder of the applied voltage appears across the leakage resistance. The ratio between these two voltage values is also the ratio between the resistance of the meter and the leakage resistance. Thus, with a little calculation, we can determine exactly how much leakage resistance actually exists.

For example, if 100 volts is applied in the case of Fig. 3, and a reading of .5 volt is obtained on a v.t.v.m. whose input resistance is 10 megohms, leakage resistance would be about 2000 megohms. Generally, when using a v.t.v.m. for this test, a reading of .1 volt or more will indicate significant leakage in the transformer. The v.t.v.m. is recommended, as its relatively high resistance on the lowest d.c. scale will provide more accurate indications.

Although repair of such components as i.f. transformers is not ordinarily attempted, it is certainly worth consideration dollar-wise and customer-wise. While some replacement type transformers are readily obtainable, there are many special types used by different manufacturers where this does not hold true, and for which no substitute proves entirely satisfactory. Rather than keep the set in the shop for an unknown length of time while attempting to obtain a replacement, you can often repair the set immediately.

Once the defective unit has been definitely found, mark the underside of the chassis to avoid error when the

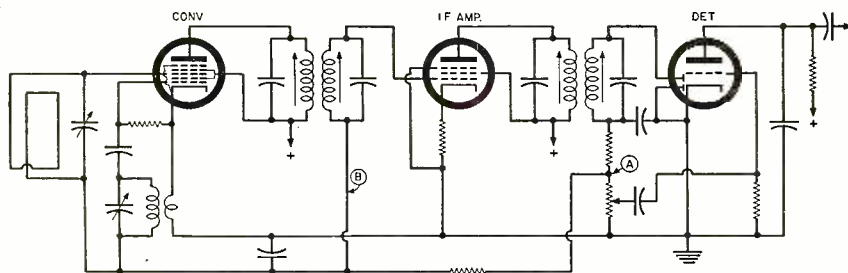

Fig. 1. Relevant portion of the circuit of a conventional broadcast receiver.

Fig. 2. Test for leakage between primary and secondary of i.f. transformer.

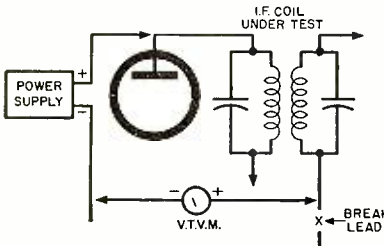

Fig. 3. Equivalent circuit for Fig. 2, showing leakage path. Meter and leakage resistances are in series across supply.

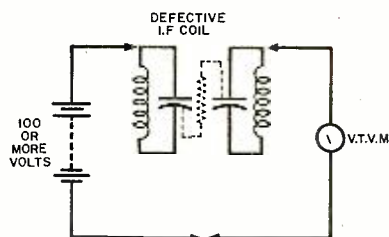
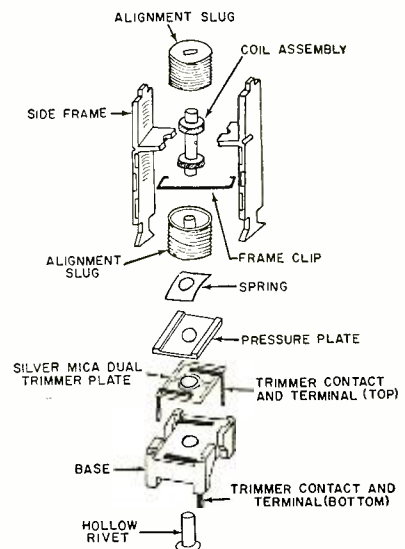

Fig. 4. Exploded view of a typical K-Tran of the type used as miniature i.f. transformer in later-day AM sets.



do you
want a
successful
career in
AVIONICS?

NOW,

at **NORTHROP INSTITUTE,**
you can combine
specialized education
in these two
TECHNOLOGICAL FIELDS!

You no doubt realize that there are **HIGH SALARY** opportunities available right now for young men trained in the field of **ENGINEERING TECHNOLOGY.** You also should realize that there will be even greater opportunities for trained men in the years just ahead.

Training takes only 2 years

The quickest way you can take advantage of this demand from Industry is to enroll at an Industry-approved school—Northrop Institute—in Aeronautical—Electronics Engineering Technology. Thousands of Northrop graduates have used this training to qualify for fine positions in Industry. **AND SO CAN YOU!**

Whether your present or future interest lies in the communications aspects of **Electronics; industrial automation; automatic guidance systems, electronic computers; or control and safety equipment systems;** whether you wish to specialize in **piloted aircraft or missiles—you owe it to yourself to find out about NORTHROP INSTITUTE TRAINING.** Just fill out and mail the coupon below. Do it now!

Approved for Veterans



Northrop
Aeronautical Institute

An Accredited Technical Institute
1119 W. Arbor Vitae Street
Inglewood 1, California

NORTHROP AERONAUTICAL INSTITUTE
1119 W. Arbor Vitae Street, Inglewood 1, Calif.
Please send me immediately the Northrop catalog, employment data, and schedule of class starting dates. I am interested in:

- Electronic Engineering Technology
- Aeronautical Engineering Technology
- Aircraft Maintenance Engineering Technology
- Master Aircraft and Engine Mechanic
- Jet Engine Overhaul and Maintenance

Name..... Age.....

Address.....

City..... Zone..... State.....

Veterans: Check here for Special Veteran Training Information.

transformer is re-installed. (If the transformer is one of the widely used *K-Tran* units, it is usually coded with a green dot next to the grid lug.) The transformer is then removed and taken out of its can. Heat the solder on each lug in turn and, with a needle, unwind the coil leads attached thereto. Put a touch of glue on each wire just above the base plate, so that the wires will stay in place when the lower assembly is removed. Unscrew the top slug. Remove the bottom slug by spreading the side bars. By further spreading these bars, the trimmer assembly can then be detached from the rest of the coil.

An "exploded" view of a complete *K-Tran* is shown in Fig. 4. The trimmer assembly is held together by means of a hollow rivet passing through the center. On the upper, or coil side, is a beaded portion of the rivet which must be removed. This can be done by using a grinder or a file. Next, push the rivet through the assembly and lift off the spring and pressure plate. The trimmer is now exposed for examination.

With the familiarity that comes from going through such a procedure once, this disassembly can be accomplished in little more time than it takes to describe.

The type of defect that usually will be observed is shown in Fig. 5. Apparently, during the process used in printing the trimmers, some of the silver paint may become smeared. This defect is now cut out using the edge of a razor blade or a very sharp, slender knife. If available, a small amount of silver paint is then applied to the metal connectors which bear against the silver mica trimmers, by again using the needle or a toothpick. The unit is then re-assembled. There is always enough excess length on the rivet so that, by using firm pressure, it may be pushed back through the assembly and beaded over. The initial rebeading is easily accomplished by using a 1/4"-shank Phillips type screwdriver. The job is completed with a ball-peen hammer. The remaining assembly is simply the reverse of the method used for disassembly. Although this procedure may, at first, seem somewhat difficult, proficiency is attained with a little practice.

Fig. 5. Leakage usually occurs when the coated-on plate of the capacitor on one side of the i.f. transformer smears over to the opposite capacitor.

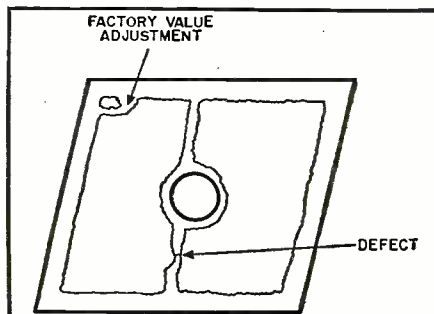

ERSIN
Welding
SOLDER
CONTAINS 5 CORES OF NON-CORRODING FLUX

World's finest!

Made especially for the
RADIO AND ELECTRONIC MARKET

Guarantees your work —
FASTER! SURER! NO CALL-BACKS!

LOWEST POSSIBLE PRICES —
PROMPT DELIVERY

SOLD ONLY THROUGH
RADIO PARTS DISTRIBUTORS!



Dept. ME48
MULTICORE SALES CORPORATION
PORT WASHINGTON, NEW YORK

SURPLUS BUYS!

NATIONAL RECEIVER—NC 240—NAVY VER-SION—Self Contained 115V—60 Cy. P.S. 6 band, switch on front panel, 100-500VC and 2-20MC. 6 band—Fair Cond. \$69.95

TRIPLETT MICROAMMETER—0-500 u/a Dc, 2 1/2" rd, bakelite case, white scale. ea. \$3.95
G. E. METER—DW41, 2 1/2" rd, 0-500 mils., New. Quant. available. \$2.95

METER—0-1 Mil (3KV scale) 3 1/2" rd, Marion—new \$3.95

FILAMENT TRANSFORMER—2.5V—10 amps. 10 KV insulation. As used in BC610. New. \$3.95

PORTABLE AUDIO AMPLIFIER—1141F. Used with 625 mine detector. Compl. w/tubes, schem., cable. L.N. 12x4x4. 9 lbs. \$3.95

TORSIONAL RELAY—Wallace & Tiernan Frequency selector. For use in applications where radio waves are control medium. \$3.95

DUAL RECEIVER RACK (ARC-5)—Br. new \$1.95
Carbon Deposit 1% RESISTOR—Kit. \$1.00

COLLINS 20 Watt MODULATION XFORMER—cased—3 for \$5.00. ea. \$1.95

SCOPE, SIGNAL GENERATOR & POW. SUPPLY (115V-60CPS) all in one unit—w/tubes, meter, schem., L.N. 60 lbs. \$19.95

COLLINS CARB. MIKE XFORM. 3 for \$2.00

RETRACTABLE PHONE CORD—latest type—3 cond.—Automatic elec. \$1.00

FONE PATCH TRANSFORMER—1 1/2 cube, cased, w/schematic—simple, efficient. \$1.00

ARC—5 XMTR. 3-4MC—exc. cond. \$5.95

TS45A/APM-3—new—w/tech manual. \$39.95

5933/807W—ruggedized version of 807. Br. New—Sylvania Boxed \$1.59, 2 for \$3.00, dozen \$15.00

POWER SUPPLY—RA-2B. Input 115V—60CPS, Output 115 to 1420VDC—450 Mils. Cabinet 19x15x12. Wt. 150 Lbs. Brand new w/spare 866A's. Reduced. \$59.95

MIN. CARBON BUTTON MIKE—C-1 (ANB-MC1) w/plug. Br. new—6 for \$5.00. ea. \$1.00

PLATE TRANSFORMER—Pri.: 115V-60CPS. Sec.: 550-0-550 220MA. (conservative) Collins cased. Each \$6.95

DB METER—Burlington 3 1/2" rd. \$4.95

REX RADIO SUPPLY CO.

88 Cortlandt Street New York 7, N. Y.



The 5-inch screen of this new airborne TV set shows a pilot his exact location.

Airborne Closed-Circuit Television

*Cockpit TV set pictures
pilot's ground location.*

AN AIRBORNE closed-circuit TV device that pictures constantly for the pilot of a jet plane the exact location of his plane in relation to the ground was unveiled recently. The device, called the "Horizontal Situation Display," automatically correlates information fed into it by navigational computers and instruments and presents a TV picture in the form of a map of the terrain below the plane. A plane image, projected over the map, always corresponds to the pilot's position over the terrain. The electronic system was developed by Avion division of *ACF Industries, Inc.* under Air Force contract.

Navigational computers have already taken over the complex job of determining a plane's true course, speed, and location. However, the pilot or a crew member heretofore still had to take the numerical information supplied by the computers and put it on a map before the pilot could determine exactly where he was in relation to his home base or destination. The Horizontal Situation Display relieves the pilot of that chore. On a 5-inch screen mounted on the instrument panel, the device shows the plane image superimposed on an aeronautical map.

In operation, signals from a navigation computer are fed into the unit and actuate controls governing map and plane image positions. The result is picked up by a remote TV camera, whose output is then applied to the cathode-ray tube on the instrument panel.

-30-

It's as EASY as This

TO INSTALL A MASTER TV SYSTEM

WITH

B-T LABS Masterline UNITS

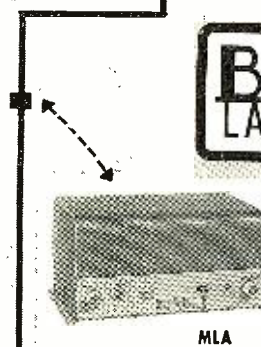

A Connect the antenna line to the INPUT of your Masterline MLA Line Amplifier. The signal is now amplified 37db (70 times).

LINE SPLITTER

B Connect a line splitter or line coupler to the OUTPUT of the MLA. You now have 2 or more branch lines for feeding to TV receivers.

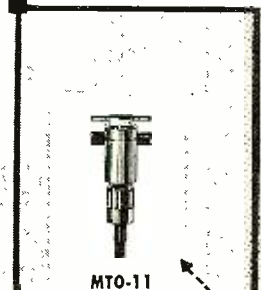

C Where the branch line is run out-of-doors, connect a Masterline MTO-11 (outdoor tap-off) wherever a TV set feed line is required.

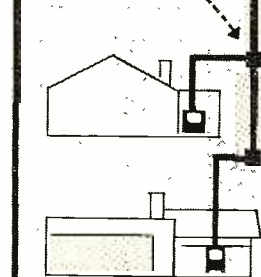

D Where the branch line serves as a riser inside a building, connect a Masterline TO1-75 or TO1-300 (wall-plate-tap-off) wherever an antenna outlet is required.

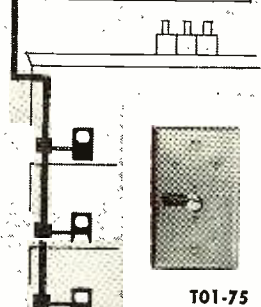

This is only one example of a Master TV System, to show the flexibility of Blonder-Tongue distribution equipment. There are many more, all covered in the new B-T INSTALLATION MANUAL.

Write for your Free copy to Dept. RTN-5

BLONDER-TONGUE LABORATORIES, INC.

9 Alling Street
Newark 2, New Jersey

Manufacturers of TV Cameras, TV Amplifiers, Boosters, Converters, Accessories and Originators of the Masterline and 'Add-A-Unit' Master TV Systems.



Model TD-55 — TUBE TESTER . . . Total Price \$26.95 — Terms: \$6.95 after 10 day trial, then \$5.00 per month for 4 months.



Model TW-11 — TUBE TESTER . . . Total Price \$47.50 — Terms: \$11.50 after 10 day trial, then \$6.00 per month for 6 months.

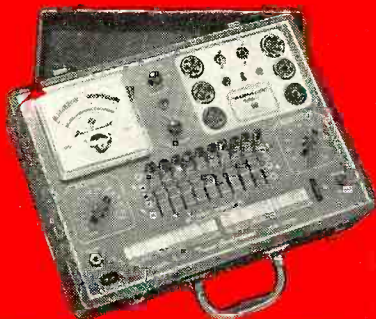

Model TV-12 — TRANSCONDUCTANCE TUBE TESTER . . . Total Price \$72.50 — Terms: \$22.50 after 10 day trial, then \$10.00 per month for 5 months.



Model 770-A — VOLT-OHM-MILLIAMMETER . . . Total Price \$15.85 — Terms: \$3.85 after 10 day trial, then \$4.00 per month for 3 months.

SHIPPED ON APPROVAL

NO MONEY WITH ORDER

NO C.O.D.

Superior's New Model TD-55 EMISSION TYPE TUBE TESTER

For the Experimenter or Part-time Serviceman, who has delayed purchasing a higher priced Tube Tester. For the Professional Serviceman, who needs an extra Tube Tester for outside calls. For the busy TV Service Organization, which needs extra Tube Testers for its field men. Speedy, yet efficient operation is accomplished by: 1. Simplification of all switching and controls. 2. Elimination of old style sockets used for testing obsolete tubes (26, 27, 57, 59, etc.) and providing sockets and circuits for efficiently testing the new Naval and Sub-Minar types.

You can't insert a tube in wrong socket. It is impossible to insert the tube in the wrong socket when using the new Model TD-55. Separate sockets are used, one for each type of tube base. If the tube fits in the socket it can be tested.

"Free-point" element switching system. The Model TD-55 incorporates a newly designed element selector switch system which reduces the possibility of obsolescence to an absolute minimum.

Checks for shorts and leakages between all elements. The Model TD-55 provides a super sensitive method of

checking for shorts and leakages up to 5 Megohms between any and all of the terminals.

Elemental switches are numbered in strict accordance with R.M.A. Specifications.

The 4 position fast-action snap switches are all numbered in exact accordance with the standard R.M.A. numbering system. Thus, if the element terminating in pin No. 7 of a tube is under test, button No. 7 is used for that test.

Complete with carrying case

\$26.95
NET

Superior's New Model TW-11 STANDARD PROFESSIONAL TUBE TESTER

- Tests all tubes, including 4, 5, 6, 7, Octal, Lockin, Hearing Aid, Thyatron, Miniatures, Sub-miniatures, Novals, Sub-minars, Proximity Fuse Types, etc.

- Uses the new self-cleaning Lever Action Switches for individual element testing. All elements are numbered according to pin-number in the RMA base numbering system.

- Model TW-11 does not use combination type sockets. Instead individual sockets are used for each type of tube. Thus it is impossible to damage a tube by inserting it in the wrong socket.

- Free-moving built-in roll chart provides complete data for all tubes. Printed in large easy-to-read type.

NOISE TEST: Phono-jack on front panel for plugging in either phones or external amplifier detects microphonic tubes or noise due to faulty elements and loose internal connections.

EXTRAORDINARY FEATURE

SEPARATE SCALE FOR LOW-CURRENT TUBES. Previously, on emission-type tube testers, it has been standard practice to use one scale for all tubes. As a result, the calibration for low-current types has been restricted to a small portion of the scale. The extra scale used here greatly simplifies testing of low-current types.

Housed in hand-rubbed oak cabinet . . .

\$47.50
NET

Superior's New Model TV-12 TRANS-CONDUCTANCE TUBE TESTER

- ★ Employs improved TRANS-CONDUCTANCE circuit. An in-phase signal is impressed on the input section of a tube and the resultant plate current change is measured. This provides the most suitable method of simulating the manner in which tubes actually operate in Radio & TV receivers, amplifiers and other circuits. Amplification factor, plate resistance and cathode emission are all correlated in one meter reading.

- ★ NEW LINE VOLTAGE ADJUSTING SYSTEM. A tapped transformer makes it possible to compensate for line voltage variations to a tolerance of better than 2%.

- ★ SAFETY BUTTON—protects both the tube under test

and the instrument meter against damage due to overload or other form of improper switching.

EXTRA FEATURE:

Model TV-12 Also Tests Transistors!

A transistor can be safely and adequately tested only under dynamic conditions. The Model TV-12 will test all transistors in that approved manner, and quality is read directly on a special "transistor only" meter scale.

Housed in hand-rubbed oak cabinet . . .

\$72.50
NET

Superior's New Model 770-A POCKET-SIZED VOLT-OHM MILLIAMMETER

USING THE NEW "FULL VIEW" METER
71% MORE SCALE AREA

Occupies exactly the same space used by the older standard 2 1/2" Meters, yet provides 71% more scale area. As a result, all calibrations are printed in large easy-to-read type.

- Housed in round-cornered, molded case. Beautiful black etched panel.

6 A.C. VOLTAGE RANGES: 0-15/30/150/300/1500/3000 Volts • 6 D.C. VOLTAGE RANGES: 0-7.5/15/75/150/750/1500 Volts • 2 RESISTANCE RANGES: 0-10,000 Ohms, 0-1 Megohm • 3 D.C. CURRENT RANGES: 0-15/150 Ma., 0-1.5 Amps. • 3 DECIBEL RANGES: -6 db to +18 db, +14 db to +38 db, +34 db to +58 db.

Complete with test leads

\$15.85
NET

USE APPROVAL FORM ON NEXT PAGE

We invite you to try before you buy any of the models described on this and the following page. If after a 10 day trial you are completely satisfied and decide to keep the Tester, you need send us only the down payment and agree to pay the balance due at the monthly indicated rate.

NO INTEREST OR FINANCE CHARGES ADDED!

If not completely satisfied, you are privileged to return the Tester to us, cancelling any further obligation.

RADIO & TV NEWS

TRY FOR 10 DAYS

before you buy!

then if satisfactory pay in easy, interest free, monthly payments. See coupon below.

Superior's New Model 77 **VACUUM TUBE VOLTMETER** WITH NEW 6" FULL-VIEW METER

Compare it to any peak-to-peak V. T. V. M. made by any other manufacturer at any price!

- ✓ Model 77 completely wired and calibrated with accessories (including probe, test leads, and portable carrying case) sells for only \$42.50.
- ✓ Model 77 employs a sensitive six inch meter. Extra large meter scale enables us to print all calibrations in large easy-to-read type.
- ✓ Model 77 uses new Improved SICO printed circuitry.
- ✓ Model 77 employs a 12AU7 as D.C. amplifier and two 9006's as peak-to-peak voltage rectifiers to assure maximum stability.
- ✓ Model 77 uses a selenium-rectified power supply resulting in less heat and thus reducing possibility of damage or value changes of delicate components.
- ✓ Model 77 meter is virtually burn-out proof. The sensitive 400 microampere meter is isolated from the measuring circuit by a balanced push-pull amplifier.
- ✓ Model 77 uses selected 1% zero temperature coefficient resistors as multipliers. This assures unchanging accurate readings on all ranges.

AS A DC VOLTMETER: The Model 77 is indispensable in Hi-Fi Amplifier servicing and a must for Black and White and color TV Receiver servicing where circuit loading cannot be tolerated.

AS AN AC VOLTMETER: Measures RMS values if sine wave, and peak-to-peak value if complex wave. Pedestal voltages that determine the "black" level in TV receivers are easily read.

AS AN ELECTRONIC OHMMETER: Because of its wide range of measurement leaky capacitors show up glaringly. Because of its sensitivity and low loading, intermittents are easily found, isolated and repaired.

Model 77 comes complete with operating instructions, probe and test leads. Use it on the bench — use it on calls. A streamlined carrying case, included at no extra charge, accommodates the tester, instruction book, probe and leads. Operates on 110-120 volt 60 cycle. Only

\$42.50
NET

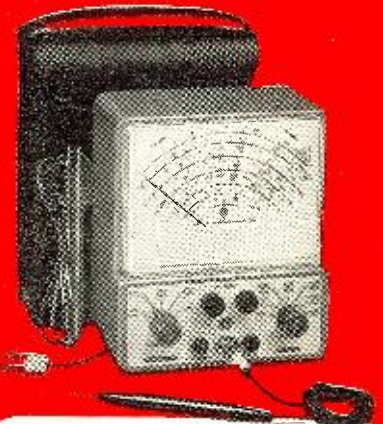

Model 77 — VACUUM TUBE VOLTMETER ... Total Price \$42.50 — Terms: \$12.50 after 10 day trial, then \$6.00 per month for 5 months.

Superior's New Model 76 **ALL PURPOSE BRIDGE**

IT'S A CONDENSER BRIDGE IT'S A RESISTANCE BRIDGE IT'S A SIGNAL TRACER IT'S A TV ANTENNA TESTER

Specifications

✓ CAPACITY BRIDGE SECTION
4 Ranges: .00001 Microfarad to .005 Microfarad; .001 Microfarad to .5 Microfarad; .1 Microfarad to 50 Microfarads; 20 Microfarads to 1000 Microfarads. Will also measure the power factor of all condensers from .1 to 1000 Microfarads.

✓ RESISTANCE BRIDGE SECTION
2 Ranges: 100 ohms to 50,000 ohms; 10,000 ohms to 5 megohms.

✓ SIGNAL TRACER SECTION
With the use of the R.F. and A.F. Probes included

with the Model 76, you can make stage gain measurements, locate signal loss in R.F. and Audio stages, localize faulty stages, locate distortion and hum, etc.

✓ TV ANTENNA TESTER SECTION
Loss of sync., snow and instability are only a few of the faults which may be due to a break in the antenna, so why not check the TV antenna first? Locates a break in any TV antenna and measures the location of the break in feet from the set terminals. Complete with R.F. and A.F. probes and test leads.

\$26.95
NET



Model 76 — ALL PURPOSE BRIDGE ... Total Price \$26.95 — Terms: \$6.95 after 10 day trial, then \$5.00 per month for 4 months.

Superior's New Model TV-50 **GENOMETER**

7 Signal Generators in One!

- ✓ R.F. Signal Generator for A.M.
- ✓ Audio Frequency Generator
- ✓ Color Dot Pattern Generator
- ✓ R.F. Signal Generator for F.M.
- ✓ Bar Generator
- ✓ Marker Generator
- ✓ Cross Hatch Generator

R.F. SIGNAL GENERATOR: 100 Kilocycles to 60 Megacycles on fundamentals and from 60 Megacycles to 180 Megacycles on powerful harmonics

VARIABLE AUDIO FREQUENCY GENERATOR: Provides a variable 300 cycle to 20,000 cycle peaked wave audio signal.

BAR GENERATOR: Pattern consists of 4 to 16 horizontal bars or 7 to 20 vertical bars.

CROSS HATCH GENERATOR: The pattern consists of non-shifting horizontal and vertical lines interlaced to provide a stable cross-hatch effect.

DOT PATTERN GENERATOR (FOR COLOR TV): The Dot Pattern projected on any color TV Receiver tube by the Model TV-50 will enable you to adjust for proper color convergence.

MARKER GENERATOR: The following markers are provided: 189 Kc., 262.5 Kc., 456 Kc., 600 Kc., 1000 Kc., 1400 Kc., 1600 Kc., 2000 Kc., 2500 Kc., 3579 Kc., 4.5 Mc., 5 Mc., 10.7 Mc., (3579 Kc. is the color burst frequency.) Complete with shielded leads

\$47.50
NET

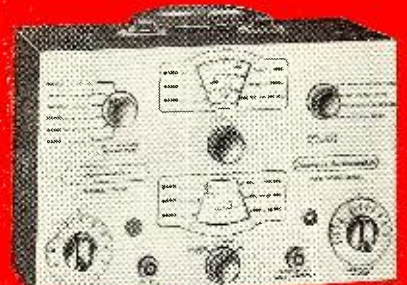

Model TV-50 — GENOMETER ... Total Price \$47.50 — Terms: \$11.50 after 10 day trial, then \$6.00 per month for 6 months.

MOSS ELECTRONIC DISTRIBUTING CO., INC.

Dept. D-466 3849 Tenth Ave., New York 34, N. Y.

Please send me the units checked on approval. If completely satisfied I will pay on the terms specified with no interest or finance charges added. Otherwise, I will return after a 10 day trial positively cancelling all further obligation.

Name

Address

City Zone State
All prices net, F.O.B., N.Y.C.

- Model TD-55 Total Price \$26.95 \$6.85 within 10 days. Balance \$5.00 monthly for 4 months.
- Model TW-11 Total Price \$47.50 \$11.50 within 10 days. Balance \$6.00 monthly for 6 months.
- Model TV-12 Total Price \$72.50 \$22.50 within 10 days. Balance \$10.00 monthly for 5 months.
- Model 770-A Total Price \$15.85 \$3.85 within 10 days. Balance \$4.00 monthly for 3 months.
- Model 77 Total Price \$42.50 \$12.50 within 10 days. Balance \$6.00 monthly for 5 months.
- Model 76 Total Price \$26.95 \$6.95 within 10 days. Balance \$5.00 monthly for 4 months.
- Model TV-50 Total Price \$47.50 \$11.50 within 10 days. Balance \$6.00 monthly for 6 months.

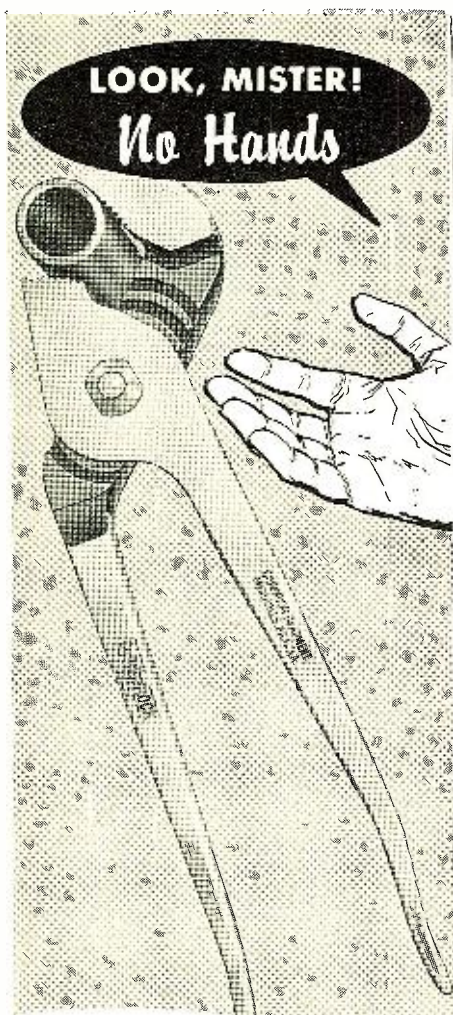

It's Self-Gripping

CHANNEL LOCK
No. 410
HEAVY-DUTY PLIER

How's this for gripping power? You won't know your own strength 'til you grab hold with this heavy-duty self-gripping plier. The Channellock No. 410 HEAVY-DUTY is actually a combination plier-wrench... and it will get into tight places you can't reach with a pipe wrench. A mighty handy, multi-purpose tool with four jaw adjustments up to 1-1/8".

ASK YOUR TOOL SUPPLIER FOR A CHANNELLOCK No. 410 HEAVY-DUTY PLIER

BE SURE IT'S
A GENUINE
CHANNELLOCK



LOOK FOR THE
TRADEMARK
ON THE HANDLE

CHAMPION DEPARTMENT TOOL COMPANY
MEADVILLE, PENNSYLVANIA

Receiving "Explorer's" Radio Signals



By D. RIPANI, W9JAQ

Some puzzling aspects concerning signals from our first earth satellite are cleared up here.

THE reception of 108.00 mc. and 108.03 mc. radio signals from Explorer I, and future satellites operating in the v.h.f. band, clearly demonstrate two interesting phenomena that may prove puzzling at first.

The first is the "Doppler Effect." Recalling high school physics, "Doppler Effect" was usually illustrated by imagining an observer standing at a railroad crossing and a train rushes by with its whistle blowing. As the train approaches this observer, the whistle's pitch sounds higher in frequency and as the train recedes the pitch becomes lower. While the train is directly abreast of the observer, the whistle's true pitch is heard. Obviously, the whistle has not changed its pitch. What has changed, though, is the velocity of propagation. As the train approached the observer the relative velocity of propagation, in relation to the observer increased and, consequently, the whistle's pitch rose in frequency. As the train sped away, the velocity of propagation decreased and the apparent frequency dropped. While the train was abreast of the observer, the relative velocity of propagation did not change and the tone heard was the true sound of the train whistle.

Like so many others, the author relegated "Doppler Effect" to some obscure corner of the brain and forgot it, that is, until the first time he listened for the Explorer on 108.03 mc.—and couldn't hear it. Using a low-noise, crystal-controlled converter feeding a Collins 75A4, set for 800-cycle band-pass, nothing was heard until the receiver was tuned about 2 kc. higher in frequency. At 108.032 the signal was heard just above the noise level. And when it had finally faded out about 9 minutes later, it was transmitting on about 108.028 mc.; a total shift of approximately 4000 cycles. Dusting off the old physics books revealed a formula for calculating Doppler shift as applicable to sound waves, but with minor alterations, it is suitable for determining frequency shift.

$\pm f_s = VF/984$
where:

$\pm f_s$ = plus and minus maximum frequency shift.

V = speed of the satellite in feet per second.

F = satellite frequency in megacycles.

With the Explorer's velocity of about 18,000 m.p.h., or 26,400 feet per second and a frequency of 108.03 mc., the value is approximately ± 2900 cycles.

This total shift of almost 6 kc. holds true for a satellite passing directly overhead but in most cases the satellite will pass at some distant point thereby lowering somewhat the total frequency shift. Here in Wisconsin, at a point nearly one thousand miles away, the maximum shift proved to be about 3200 cycles. A quick substitution of Sputnik's frequency of 20 mc. in the formula (same approx. speed as Explorer) gives an answer of ± 500 cycles—which explains why most listeners did not notice the Doppler shift on Sputnik's signal. On the other hand the Doppler shift can be a real problem in space communications unless automatic frequency control devices are incorporated in the receivers—as jets, using single-sideband communications have already discovered. In fact, as an interesting sidelight, a few minutes with the formula will reveal some pertinent as well as troublesome future communications problems that may need solving when super-speed spaceships take off. Using a speed of 90,000 m.p.h. and a frequency of 200 mc., this Doppler shift can amount to 50 mc.!

The other interesting observation involves the orbiting time. Explorer's time of complete orbit was given as almost 115 minutes, yet our clocked intervals came to 121 minutes. This proved puzzling until it was recalled that although the Explorer requires only 115 minutes to return to the same spot in space, the earth beneath it has in the meantime moved almost 2000 miles further east and for "line of sight" reception of Explorer's signal, the satellite had to continue for an additional ninth of an hour, about 6 minutes, to get in radio range. —30—

RADIO SHACK BARGAIN

6

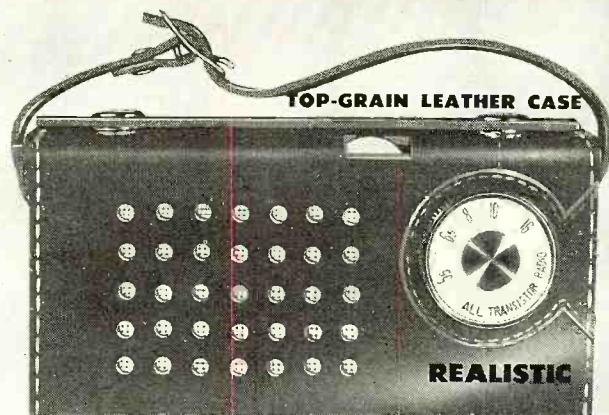

\$29.95

Radio: RN-6277
Ship. 3 lbs.
Battery: RN-2502
Sale! 75c

TRANSISTORS

EXCLUSIVE

GUARANTEED to equal or exceed 6-TRANSISTOR RADIOS PRICED \$40 - \$50 - \$60 - \$70



ENTIRELY LEATHER ENCASED! Radio Shack's fabulous 6-transistor midget-portable radio bargain also includes these exciting features: built-in speaker, separate earphone with cord and jack, printed circuitry, ferrite antenna, AGC superhet circuit, conelrad markers, enough audio "sock" to drive even 12" speakers from phone jack, top-grain leather including strap — no plastic! Runs 100's of hours on a single tiny 9V battery — no short-life flashlight cells! True 5½" x 2¾" x 1½" pocket size. Over 18,000 mail-order customers tell us it's the best buy in the world! Mail your order today — immediate delivery.

SALE! 4-SPEED VARIABLE-SPEED TURNTABLES!



★ Built-in Optical Stroboscope

Built like a battleship! Solid castings, precision machining, hi-fi performance, big and quiet heavy-duty 4-pole motor with instant variation of all four speeds. Famous "Realistic"-brand quality. And it's yours — while our LIMITED supply lasts — at a price actually lower than a record changer. Strobe mounted under table; viewed thru lighted optical system. 13¾" W, x 14½" D. Clearance above 2" and 4½" below. 110-130V. 60 cy. AC.

Comparative Market Value ~~\$79.50~~

SALE! \$39.50

\$4 DOWN, \$5 MONTHLY

Order No. RN-9050 Ship. 23 lbs. \$39.50
Rock Maple Base for Realistic Mark IX
Order No. RN-9050R Ship. 10 lbs. \$12.00

SALE! REALISTIC HI-FI TONE ARMS

- ★ Silicon Oil VISCOUS Damped
- ★ Exclusive PLUG-IN Heads (2)
- ★ 4 Separate Balance Weights For Latest Model Pickups

Licensed under CBS
patent no. 2676806



12" Arm — ~~\$29.95~~
16" Arm — ~~\$39.95~~

Your Choice **\$13.90**

12" Arm — Order RN-8148
16" Arm — Order RN-6602

SALE! \$3.50 TEST TAPE!



95¢

7 COMPLETE professional tests for tape recorders. Has instructions to test timing, record level, —10 db record level, head alignment, fine alignment, signal-to-noise. Ship. wt. ¾ lb. Order No. RN-D110.

IN THE WHOLE WORLD ONLY RADIO SHACK HAS THE 1958 REALISTIC FM TUNER



FM II

3 Microvolts for 30 DB Quieting **\$47.50**
\$5 Down \$5 Monthly

YOU GET a fabulous high fidelity tuner with specifications no one can duplicate under \$80.00 — Armstrong FM circuitry, balanced AFC, tuned RF stage, 3-gang condenser, 6 tubes (2 dual for 8-tube function), ultra-compact size.

Other Realistic FM-II specs: 20-20,000 cps freq. resp.; gold, maroon-and-white metal cabinet; size: 9½" W x 4¾" H x 6¾" D. 117V 60 cy. AC. Ship. wt. 9½ lbs. Order 36-RN-888.



FREE! 224-Page Electronics and Hi-Fi Buyers' Guide

MAIL ORDERS } **RADIO SHACK CORP.**
TO: 167 Washington Street, Boston 3, Mass.

- Realistic 6-Trans. Radio (#RN-6277) at \$29.95
- 9 Volt Battery for Radio (#RN-2502) at 75c
- Realistic Turntable (#RN-9050) at \$39.50
- Unfinished Base for Table (#RN-9050B) at \$12.00
- Realistic 12" Tone Arm (#RN-8148) at \$13.90
- Realistic 16" Tone Arm (#RN-6602) at \$13.90
- Test Tape (#RN-D110) at 95c
- Realistic FM-II Tuner (#36-RN-888) at \$47.50
- FREE: 224 Pg. Electronics Buyers' Guide

Check Cash Purchase Order

Name
Street
City Zone State

RADIO SHACK CORP.

BOSTON, MASS.

NEW HAVEN, CONN.

Over 35 Years of Continuous Service to Electronics, Radio, Science!

May, 1958

99



NOW AVAILABLE
... a quality line of
exact replacement magnetic
tape heads ...

INCLUDING STEREO!

*You owe it to your
Customers-*



5B20

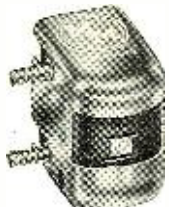

5L20U



3L20S



10L17



7EM12

**TO INSPECT AND RE-
PLACE RECORDING
HEADS BEFORE TONAL
BRILLIANCE IS LOST**

In five-hundred hours or less of operation, high frequency response can fall off to a measurable degree due to the abrasive action of the tape passing over the head in the presence of normal amounts of dust in the air. If visual inspection discloses excessive wear on the active surface of the head, your customer will appreciate your replacing this unit with an MM head to enhance his listening pleasure and protect his tapes.

**THE
MICHIGAN
MAGNETICS
LINE ...**

NO.		LIST PRICE
5B20	Stereo	\$22.50
5B20LS	Stereo	22.50
10B20LS	Stereo	22.50
5L20U		8.50
3L20S		7.50
	Also replaces 2L35 & 2M40	
10L17		8.50
10L17S		7.50
	Also replaces 9L20S & 10M20A	
40EM12		6.00
7EM12		6.00

Order today

**OR WRITE FOR ANY ADDITIONAL
INFORMATION YOU MAY REQUIRE!**



DISTRIBUTOR INQUIRIES INVITED

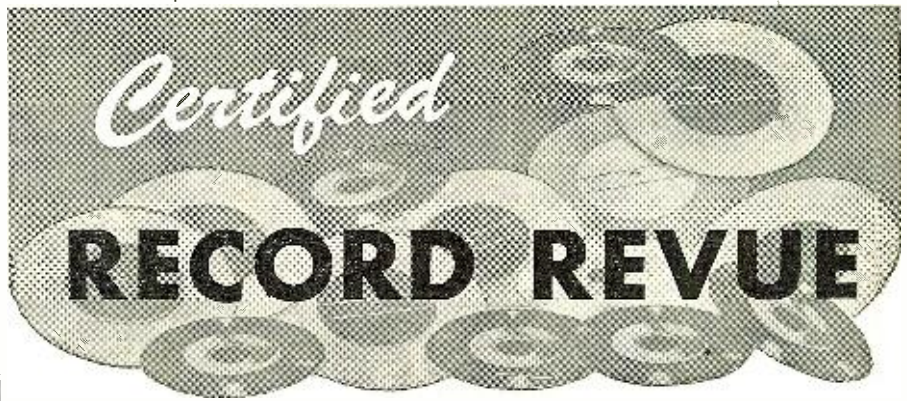

By **BERT WHYTE**

IN SPITE of all the smoke-screen and whoopla to the contrary, you can put it down in your book that the stereo disc is a reality. By the time you read this chances are that many of you will already have obtained a stereo cartridge and will have purchased your first stereo disc. I don't mean to imply that there will be stereo discs festooning the walls of record shops, but there will be enough of them issued or announced to stimulate any serious hi-fi man into action.

The San Francisco and Los Angeles Audio Shows were really the jump off for the stereo disc, even though the products of the major record manufacturers were heard only as experimental demonstration discs in the rooms of the various cartridge manufacturers. But Sid Frey and his "Audacious Fidelity" stereo records were there and the cartridge boys were there and between the two of them, enough stereo noise was made so that the major record companies and the public got the message loud and clear.

As of right now you can buy the *Audio Fidelity* stereo discs in many of the New York hi-fi shops, and you can buy either an *Electro-Voice* ceramic stereo cartridge, or a *Fairchild*, or *Miracwin* magnetic stereo cartridge so you can hear 'em. Within a few weeks there will be stereo cartridges forthcoming from *Brush*, *Shure*, *Webster Electric*, *Pickering*, *Grado*, *Weathers*, *ElectroSonic*, and others.

I know of quite a few special stereo pre-amps and single chassis-double amplifier stereo power amps being frantically readied by manufacturers big and small. As for compatibility, it has been pretty well established and accepted that unless you own a monaural pickup with exceptionally high vertical compliance, playing a stereo disc with anything else will injure it for future stereo use. In other words when playing stereo discs the prudent person will be playing them with a stereo cartridge.

All this activity on the stereo disc is quite understandable. As a luxury item, hi-fi has felt the pinch of the recession too, in fact more than many people are willing to admit. The stereo disc looks like the way out of the economic jungle, thus the push. If all goes well, I'll review the first stereo discs, next month.

BEETHOVEN
CONCERTO FOR VIOLIN AND
ORCHESTRA IN D MAJOR
Arthur Grumiaux, violinist with Concertgebouw Orchestra of Amsterdam conducted by Eduard Van Beinum. Epic LC3420. Price \$3.98.

The umpteenth version of this great concerto, but not one which can be lightly dismissed. Grumiaux and Van Beinum team up to give us one of the most distinguished performances on records. Theirs is the straight-

forward, "classical" approach and a refreshing change from the mannered displays which characterize so many performances these days. Grumiaux's clean, vibrant tone and Van Beinum's judiciously paced and proportioned accompaniment earn for them a place beside the august Heifetz/Munch and Milstein/Stern recordings.

The recorded sound is generally quite clean, with an excellent balance between violin and orchestra. Only a somewhat over-resonant bass line keeps the sound below the sonic heights reached by the Heifetz recording.

TCHAIKOVSKY
SYMPHONY #6 (PATHETIQUE)
New York Philharmonic Orchestra conducted by Dimitri Mitropoulos. Columbia ML5235. Price \$3.98.

As most readers are probably aware, Mitropoulos is leaving his post as conductor of the New York Philharmonic this season, to be succeeded by the redoubtable Leonard Bernstein. Mitropoulos henceforth will devote most of his talents to conducting opera at the Metropolitan. Mitropoulos' conducting has always been the subject of much controversy. In some types of repertoire he is unsurpassable . . . and in other types he is nigh unbearable. I have always had a suspicion that the music in which Mitropoulos seems least comfortable, is of relatively little moment to him. I think this kindly, talented man has the latent ability to conduct superbly, any work of music, provided he has deep convictions about the worth of the music. He has always been a tireless experimenter and an innovator in his choice of programs. He has always championed "new" music and I particularly remember an impassioned speech he made to an audience some years ago at the Ravinia Festival in Chicago, upbraiding them when attention wandered from some modern score. Thus his choice of program material at Carnegie Hall was often subject to criticism from the conservatives in the Philharmonic Society and his musical adventuring constrained. His recording career is equally chequered . . . *Columbia*, like all record companies must depend on a certain number of "potboilers," symphonic warhorses which they must have in their record stables to appeal to a large public. Mitropoulos has had to contribute his share, with results which were not consistently happy.

But to *Columbia's* credit, there have been occasions when Mitropoulos was allowed to take the bit in his teeth and strike out in new directions. Thus we have some memorable legacies of Mitropoulos's tenure with the Philharmonic. Who can forget his masterly version of Alban Berg's "Wozzeck," the gi-

The opinions expressed in this column are those of the reviewer and do not necessarily reflect the views or opinions of the editors or the publishers of this magazine.

RADIO & TV NEWS

gantic strength of his reading of the Shostakovich Tenth Symphony, or the searing intensity he applied to the Vaughn Williams 4th Symphony? And one can only hope that Columbia had the good sense to record and will some day issue his tremendous performances of the Mahler 3rd and 6th symphonies.

In his appearances with the Metropolitan, Mitropoulos is evidently enjoying the opportunity to work with this larger scaled music. He has already earned the commendation of the critics for the revitalized orchestral sections in the music of the more normal operatic repertoire and has elicited rave notices for his truly fabulous performances of Straus' "Salome" and "Elektra."

Well, I haven't mentioned this recording of the "Pathetique," thus far, mainly because I felt a tribute was in order to a very fine gentleman and conductor, who has often been poorly (and often unjustly) served by the critics. This recording is typical of what I was talking about . . . it is a good, well-proportioned reading, happily free from the mannered sentimentality with which so many conductors insist on festooning the work. But neither does the reading strike any sparks . . . it is as if Mitropoulos had decided after numberless performances of the work that there wasn't much left to say. More is the credit to him if this be so . . . rather this than to become banal and trite with a great show of obviously contrived drama.

As a sonic achievement, this recording is quite good . . . a big, full, high-level recording that is equal to and in some ways superior to the Kubelik and Monteux recordings. Summing up . . . not Mitropoulos at his brilliant best, but certainly good enough to satisfy those who will be buying the record for its excellent sound.

HAYDN
SYMPHONY #96

MOZART
SYMPHONY #35 (HAFNER)
Detroit Symphony Orchestra conducted by Paul Paray. Mercury MG50129. Price \$4.98.

Here is Paray again cutting across the line of his musical "nationalism," this time with Papa Haydn and Mozart. The Haydn reading is well executed, with proper respect for tempi and dynamics. The Mozart was really quite a surprise . . . being, quite possibly, one of the finest versions on records. It has grace, lyricism and at the same time plenty of zest and spirit in the *allegro* and *presto* sections. A few days after I heard this recording, I learned why Paray was not to be taken lightly as an interpreter of Mozart. It seems that during the recent Mozart year celebration, he had an award conferred on him by the Mozarteum of Salzburg, for "distinguished service to the music of Mozart," the only conductor in America so honored. Very sharp, clean sound, with acoustics slightly less resonant than ideal, characterize the two works on the disc.

SCHUMANN
SYMPHONY #3 (RHENISH)

Detroit Symphony Orchestra conducted by Paul Paray. Mercury MG50133. Price \$4.98.

Music is generally thought of as being an international language, but it is surprising how many conductors are "nationalistic," specializing in the music written by composers of their native lands. Thus we bring to mind conductors like Kubelik and Talich who espouse the cause of Dvorak, Smetana, and Janacek, the late Toscanini with his Verdi and Rossini, Bruno Walter with Beethoven, Brahms, and Mahler, and Paul Paray with Ravel, Debussy, Franck, and Roussel. Of course, no conductor can limit his repertoire entirely to native composers and hope

Enjoy glorious Stereophonic Sound with your present Hi-Fi system*

new **STEREO** preamplifier

*With the versatile 208, simply add another amplifier and speaker to your present Hi-Fi system for thrilling Stereophonic sound from any source.

THE **Grommes 208**

ALL NEW CONTROL CENTER FOR STEREOPHONIC HI-FI SYSTEMS

New exciting control flexibility from a whisper to concert hall volume, retaining the magnificent quality and 3 dimensional depth of living sound.

This new stereo preamplifier offers amazing flexibility . . . perfect control of all the integrated units of the entire system. It's versatile in application . . . you can use any pair of high quality basic power amplifiers, your favorite type of speaker system, the stereo source of your choice . . . FM-AM tuner, tape, phono pickup and, when available, TV. The serious music lover who has enjoyed monaural high fidelity to the fullest will rejoice in the new depth of stereophonic sound as unified and controlled by the Grommes 208. Handsomely styled, beautifully finished. For tabletop or cabinet installation.

Audiophile Net Price \$124.50

See your dealer or write for complete specifications.

Your Grommes dealer will be happy to demonstrate this new "Best Buy in Hi-Fi". Also - see and hear the complete Grommes High Fidelity line - amplifiers, preamplifiers and tuners - each one the Best Buy in its price class.

Send complete details on the new Grommes 208 and the complete High Fidelity line.

Grommes - Division of Precision Electronics Inc.
Dept. R-5, 9101 King St., Franklin Park, Illinois

Name _____
Street _____
City _____ Zone _____ State _____

DYNAKIT

Amplifier Kits

A proven circuit of finest sound quality in a new deluxe 60 watt model and standard 50 watt model



Mark III 60 watts \$79.95*

4, 8, 16 ohm outputs net

The new Mark III includes all the sensational attributes of the popular Mark II plus these outstanding deluxe features

- ★ 60 watts at less than 1% distortion. Instantaneous peak power of 140 watts. IM less than .05 at average listening levels.
- ★ Choke filtering and low noise circuitry reduce hum and noise to 96 db below 60 watts.
- ★ New rugged KT-88 tubes and other heavy duty parts used conservatively.

Mark II 50 watts \$69.75*

8, 16 ohm outputs net

The Mark II is the best buy in high power high fidelity kits

- ★ Ease of assembly due to uniquely simple circuitry and printed circuit construction with factory-mounted parts.
- ★ Highest stability using patented stabilizing networks with minimum number of phase shifting stages. Suitable for all loudspeaker systems including electrostatic.
- ★ Dyna Biaset (patent pending) for simplified adjustment and complete freedom from effects of unbalanced components. No balancing adjustments required to meet published specifications.
- ★ Dynaco Super-Fidelity output transformer with patented para-coupled windings. This is the finest available transformer of its type for the most critical audio uses.

Available from leading Hi-Fi dealers everywhere. Descriptive brochure available on request.

* Slightly higher in West

DYNACO INC.

617 N. 41st Street • Philadelphia 4, Pa.
Export Division: 25 Warren St., New York 7, N. Y.

to gain wide recognition. So the Italian Toscanini became a great conductor of the music of Beethoven, and thus Frenchman Paray is highly regarded for his readings of Schumann.

This recording of the Schumann "Rhenish" symphony, continues in the vein of Paray's readings of the Schumann 2nd and 4th symphonies. It is vigorous, almost earthy and at the same time is splendidly lyrical. In this most massively constructed of all the Schumann symphonies, Paray elicits some noble sounds from his big orchestra. Although the acoustics of the new Ford Auditorium in Detroit where this recording was made are somewhat "dry" as compared to the old Orchestra Hall, the engineers have been able to cope with it and a listen to the wonderful broad brass chordal effects in the 4th movement will confirm this.

The sound, in general, is very clean and crisp, with a fine balance and deeply resonant bass line. Evidently Paray enjoys this score, for if you will listen carefully at the beginning of the third movement, you can hear him singing the lovely melody introduced by the clarinets and bassoons. All in all, an extremely effective performance, enhanced by the excellent sound.

A WORLD OF MUSIC
Capitol PA08412. Price \$4.98.

SERENADE
Capitol PA08413. Price \$4.98.
Capitol Symphony Orchestra conducted by Carmen Dragon.

These two albums should rack up a lot of sales for *Capitol*. They certainly have all the elements to succeed. In a World of Music, Carmen Dragon trots out some tired war-horses like the Prelude to Carmen, Smetana's "Dance of the Comedians," Die Fledermaus Overture, Londonderry Air, La Cucaracha, and others of similar persuasion, and proceeds to whip them into life. In big, lush arrangements, Dragon gets some fine spirited playing from his exceptionally good orchestra.

In "Serenade," Dragon flips the other side of his musical coin and gives out with richly romantic fare like Grieg's "Ich Liebe Dich," Mendelssohn's "On Wings of Song," Kreisler's "Old Refrain," and others. Here, too, is orchestral playing of uncommon merit. Shared by both albums is a great, clean sound of the multi-mike type. The "World of Music" has some of the most remarkable acoustic treatment I've ever heard, and the "presence" this affords, especially to the brass, is nothing short of phenomenal.

VIVALDI
L'ESTRO ARMONICO
(12 CONCERTI GROSSI)

Jan Tomasow and Willi Boskowsky, violinists, with Chamber Orchestra of the Vienna State Opera conducted by Mario Rossi. Vanguard BG572. Special Price \$9.96. Three discs.

The old *Vox* recording of this work which has served so well, will have to give way to this new *Vanguard* effort. This is in every way superior . . . the performance is better integrated, much smoother while maintaining its vigor. The soloists are absolute top-drawer and their confident, assured playing falls lovingly on the ear.

The ensemble work of the orchestra is superb, very precise and polished. The sound is perhaps the most outstanding difference between the two albums. The *Vox* was a good recording for its day, but in comparison to this it seems thin and formless. Here we have a moderately close-up sound with all the strings cleanly articulate and a big acoustic perspective allowing for a sound of great projection and brilliance.

The 12 concerti are a source of endless fascination, but if this is your first experience

DYNAKIT

Preamplifier

An Outstanding Companion
Kit to the World Famous
Dynakit Amplifiers



This handsome new control unit gives crystal clear, noise-free reproduction from any modern program source. Its unique all feedback design by David Hafler sets a new standard of pre-amplifier performance. The design of the Dynakit preamplifier is a synthesis of outstanding features which produce smoother, more natural sound. Compare these features with any other units regardless of price.

★ **Unequaled performance**

Actually less than .1% distortion under all normal operating conditions. Response ± 5 db 6 cps to over 60 kc. Distortion and response unaffected by settings of volume control. Superlative square wave performance, and complete damping on any pulse or transient test.

★ **Easiest assembly**

All critical parts supplied factory-mounted on XXXP printed circuit board. Eyeleted construction prevents damage to printed wiring. This type of construction cuts wiring time by 50% and eliminates errors of assembly. Open simplified layout offers complete accessibility to all parts.

★ **Lowest noise**

Integral dc heater supply plus low noise components and circuitry bring noise to less than 3 microvolt equivalent noise input on RIAA phono position. This is better than 70 db below level of 10 millivolt magnetic cartridge.

★ **Finest parts**

1% components in equalization circuits to insure accurate compensation of recording characteristics. Long life electrolytic capacitors and other premium grade components for long trouble-free service.

★ **High flexibility**

Six inputs with option of extra phono, tape head, or mike input. Four ac outlets. Controls include tape AB monitor switch, loudness with disabling switch, full range feedback tone controls. Takes power from Dynakit, Heathkit, or any amplifier with octal power socket.

★ **Outstanding appearance**

Choice of bone white or charcoal brown decorator colors to blend with any decor. Finished in indestructible vinyl coating with solid brass escutcheon.

★ **Best Buy**

Available from your Hi-Fi dealer at only \$34.95 net (slightly higher in the West), and yet the quality of performance and parts is unexcelled at any price.

Descriptive brochure available on request

Pat. Pending

DYNACO INC.

617 N. 41st St., Philadelphia 4, Pa.
Export Division: 25 Warren St., New York 7, N. Y.

with them it is suggested that you take them in easy doses, say one side at a time. Even the most dedicated music lover might be a little weary if he tried to listen to all six sides and 12 concerti in order!

While not as plushly packaged as the *Vox* album, on the special anniversary deal it's almost 5 dollars cheaper in price and with its other advantages, is without question the recording of choice.

CONCERT ENCORES

Mantovani and his Orchestra. London LL3004. Price \$4.98.

London's breadwinner has come up with another album that is certain to hit the best-seller lists. Concert Encores in this case is pretty much on the "pop" concert side with staples like "Clair de Lune," the "Can-Can" from La Boutique Fantasque, "Song of India," "Perpetuum Mobile," and others. The performances are in Mantovani's distinctive style, with great soaring strings in the huge, live acoustics, over-all bright clean sound.

DEBUSSY

IMAGES POUR ORCHESTRE

L'Orchestre de La Suisse Romande conducted by Aulfo Argenta. London LL1735. Price \$4.98.

Unhappily for music lovers everywhere, this is probably one of the last recordings by the brilliant young Spanish conductor, Aulfo Argenta. Mr. Argenta's most promising career was cut short by his untimely death in a recent auto crash. Strange that so much of the young musical talent in the world have met their deaths in accidents these past few years. First there was William Kapell, then Guido Cantelli, and now Argenta. All the more tragic when one considers that conducting seems to be a profession with great longevity. Toscanini was almost 90, Monteux is over 80, so is Bruno Walter and Beecham and Klemperer are well into their seventies.

The most familiar number in this work is, of course, "Iberia." "Gigues" and "Ronde de Printemps," while interesting in their own right, have not had the popular appeal of "Iberia." Although this is music composed by a Frenchman, "Iberia" so uniquely captured the flavor of the Spanish idiom, that it became part of Spain's musical traditions. Thus it should not be surprising to find "Iberia" as a staple in the repertoire of a Spanish conductor, nor surprising to find that in the hands of a gifted Spanish conductor such as Argenta, that the score takes on new hues and meanings.

Argenta turns in a stunning performance combining the essential grace and rhythm of the score with nuances and subtleties of dynamics and expression which are unmistakably Spanish. Fortunately, the Suisse Romande players caught the spirit of the occasion and Argenta has managed the minor miracle of making an essentially Swiss-French orchestra sound like they were straight out of old Madrid.

London has lavished some superb engineering on the disc, as is evident in the silken smoothness of the strings, the bright urgency of the brass, and the clean sharp transients of the percussion. Wrapped in very live, spacious acoustics, the over-all sound is compelling in its realism.

If you particularly enjoy Spanish music, you would be wise to acquire this disc and all of Argenta's previous output, including the notable "Music of Spain" series. With Argenta gone, his discs are likely to become hard-to-get collectors items.

MUSIC FOR STRINGS

Leopold Stokowski conducting his Symphony Orchestra. Capitol PA08415. Price \$4.98.

Eureka! At long last *Capitol* seems to have

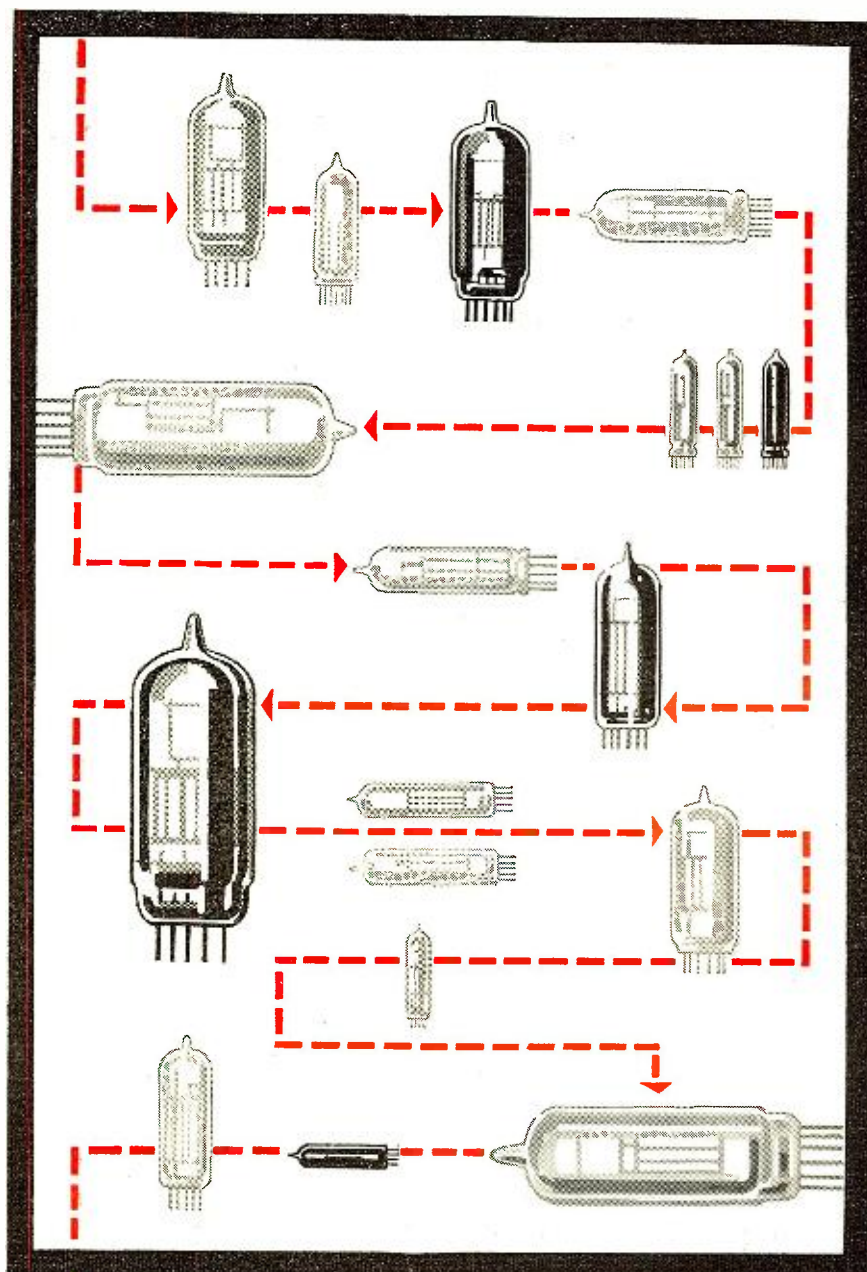

When circuits must be trouble-free get SONOTONE LONG-LIFE TUBES

Sonotone has specialized in miniature and subminiature tubes exclusively since 1939. Through this specialization, we have developed tubes that can take heat and vibration in stride and still deliver a long life of top performance. Sonotone tubes have proven their reliability in civilian as well as exacting military needs.

Sonotone could be the answer for your tube problem. For full information about all Sonotone tubes, just write or call:

Sonotone[®]

Electronic Applications Division, Dept. TN-58

ELMSFORD, NEW YORK

CORP.

foundation for
the world's
finest high fidelity
systems

marantz

* Marantz components have achieved recognition as the finest high fidelity amplifying equipment available. Truly worth the difference.

* Marantz lives up to specifications by a wide margin whether you judge by your ears, by test equipment, by looking at the "innards" or, we hope, by all three. With Marantz you do get what you are paying for.

* Servicing problems are almost non-existent! 100% inspection and testing of every unit, coupled with superior construction techniques and rugged, conservatively rated component parts will ensure trouble-free operation. A full one-year warranty accompanies all Marantz Products.

* Most carefully engineered circuitry results in lowest distortion, lowest hum and noise, and highest listening pleasure.

Audio Console \$153
(Cabinet extra)

Power Amplifier \$198

Electronic Crossover \$90
(Cabinet extra)

Slightly higher
in West and
Deep South

write for literature

marantz company

25-14 Broadway,
Long Island City 6, N. Y.

solved the problem of balance in its Stokowski recordings. This is sheer magnificence, with the first and second strings lushly smooth, the cello rich and resonant and, above all, a truly dark and sonorous contrabass sound lending weighty support to the brilliance of the higher string choirs. What a difference! I am indeed impressed. The program here is designed to show off the Stokowski mastery of strings and it does so in most convincing fashion, as anyone who gives this a listen will agree.

The first side opens with two Bach transcriptions and three Gluck pieces. The second side has the incredibly lovely Borodin "Nocturne" and the haunting beauty of Rachmaninoff's "Vocalise" sandwiching the brilliant "Moto Perpetuo" of Paganini. The absolute sensation on this disc and worth the price alone, is the second of the Bach works, the "Preludio." Obviously, Stokowski could not have had this string group together as a unit for very long. Yet in this "Preludio," is some of the finest string playing I have heard since Stokowski left the Philadelphia Orchestra.

Here is your massed precision, the superb attacks and ritards, the utterly expressive phrasing and dynamics, all in the glowing lambent beauty of tone that has come to be recognized as "Stokowskian." Would that the recent "Tocatta and Fugue in D minor" been accorded such splendidly balanced recording! Oddly, in the surge and swell of those lovely strings in the "Preludio," it was reminiscent of the "Tocatta" of long years past. This is simply fabulous!

It is fervently hoped that now *Capitol* seems to have found the key to balance, that it will be applied to their program of more expensive works.

THE CONCERT MASTERS OF NEW YORK

David Broekman, conductor. *Decca* DL9955. Price \$3.98.

Here, too, is string playing of the highest order from a group aptly named the Concert Masters of New York. This group quite literally is composed of concert-masters . . . men who were either soloists or first desk men with most of the major symphony orchestras in this country. Under the guidance of the well-known David Broekman, they display their talents on a Bach "Chaconne" and the 3rd "Brandenburg Concerto" on the first side and then on the second side they tackle the incredible complexities of Paganini's "Caprices," including the famous 24th caprice which is used in the "Rhapsody on a Theme of Paganini" by Brahms and Rachmaninoff. It is a fantastic feat and a fantastic sound to hear these massed strings perform the pyrotechnics of the Paganini caprices as if they were but a solo instrument.

The string sound is miked fairly close, but with good spacious acoustic perspective and is alternately super smooth or crisply bright and incisive as the scores demand. I think I can safely say that this is the finest classical recording *Decca* has ever made in the United States.

Most people think of Mahler as a gloomy brooding type of composer, until they hear his 4th symphony and realize that even Mahler had some sunshine in his soul. There is little doubt that this symphony is the most lyric of his works and quite easy for most people to assimilate. It abounds in bright little dance-like figures and melodies of haunting beauty and poignancy.

MAHLER
SYMPHONY #4
Anny Schlemm, soprano, with Saxon State Orchestra of Dresden conducted by Leopold Ludwig. *Decca* DL9944. Price \$3.98.

For many years the old Bruno Walter was the preferred recording, withstanding the assaults of several newer versions. Now it must give way to this superb reading by Ludwig. This conductor, little-known in this country, has managed just the right tempi, used just the right phrasing and dynamics, and achieved just the right balance for an almost totally satisfactory recording. Anny Schlemm has not the most suitable voice for the demands of Mahler, but she is steady and intelligent and displays very good taste in her rendition.

Soundwise, this is one of the most "hi-fi" recordings to come from *Deutsche Grammophon*. The engineers have used their fabulous knowledge of acoustic balance as always, but in this instance with a closer mike pick-up which affords great presence. The resultant sound is wide in range, clean and bright, but with that natural smoothness that characterizes *Deutsche Grammophon* sound.

Well, that is that, for this month. I hope to have a number of standard discs for your edification along with whatever stereo discs I can lay my hands on for reviewing. In any case, I'll let you know what is going on in "stereo disc-ery."

-30-

Heath Company, a subsidiary of Daystrom, Inc., has completed occupancy of its new plant on the shore of Lake Michigan near Benton Harbor. With over 140,000 square feet of the most modern plant equipment, this factory becomes the largest in the nation devoted to direct-mail selling of electronic instruments in kit form. The company formerly occupied seven separate buildings.

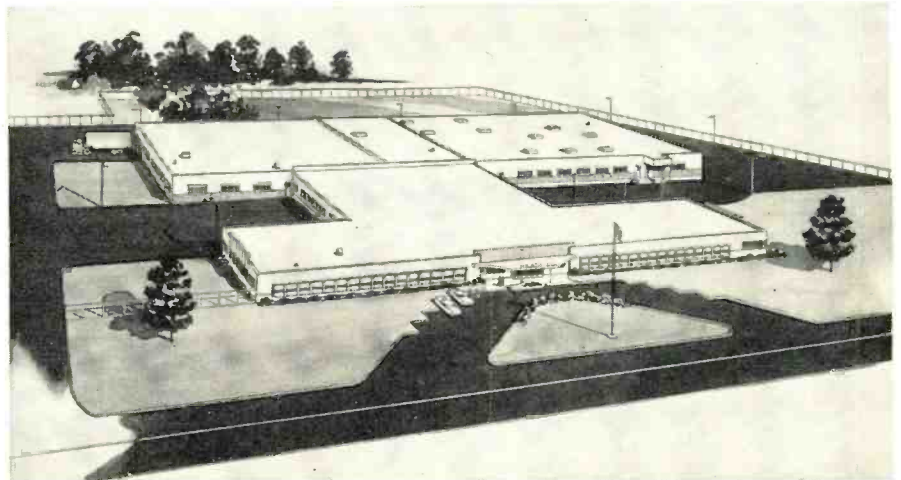

RCA Reg. \$11950 RADIATION COUNTER ON SALE AT MCGEE for \$2995

RCA Model WF-10A, Radiation Geiger counter for amateur and professional use. Explore for Uranium or check for atomic fall-out radiation. Complete with test sample. Simple to use, weighs only 5 lbs. In aluminum case. 7 3/4" x 8 1/2" x 3 1/2". Indicates presence of radioactivity in 3 ways, by meter, neon light and headphones. Requires 2 Burgess XX45 batteries and 3 - #2 flashlight cells. Battery kit, \$5.29 extra. 3 sensitivity ranges, 0-100, 0-1000 and 0-10,000 counts per minute. A terrific value. RCA Model WF-10A with tubes and headphone, less batteries, \$29.95. Battery kit, \$5.29 extra.

RCA Model WF-12A, Radiation Geiger counter. Similar to WF-10A, except has an external probe. Priced with tubes and headphones at \$34.95, less batteries. Kit of 2-XX45 Burgess "B-1" plus 3 #2 flashlight cells, \$5.29 extra.

RCA Model WF-11A, Radiation Geiger counter. Explore for Uranium or check for atomic fall-out. Uses extra sensitive Bismuth tube. Test sample included. Simple to use, weighs only 5 lbs. Weatherproof case 7 3/4" x 8 1/2" x 3 1/2". Indicates presence of radioactivity 3 ways, by meter, neon light and headphones. Requires 2 Burgess XX45 batteries and 3 #2 flashlight cells. Battery kit, \$5.29 extra. 3 sensitivity ranges, 0-200, 0-2000, 0-20,000 counts per minute. A terrific value. RCA WF-11A, Sale price, \$37.95 with tubes and headphone. Battery kit, \$5.29 extra.

RCA Model WF-15A (not illustrated). Has 10 sensitive tubes, 3 ranges to 100,000 counts per minute. Size, 11" x 4 7/8" x 7 1/2". Weight 8 lbs. Original price, \$475.00. McGee's Sale price, \$99.50. Battery kit, \$5.37 extra.

RCA Model WF-16A (not illustrated). Has 10 sensitive tubes, 3 ranges to 200,000 counts per minute. Size, 11" x 4 7/8" x 7 1/2". Weight 8 lbs. Original price, \$750.00. McGee's Sale price, \$149.50. Battery kit, \$5.37 extra.

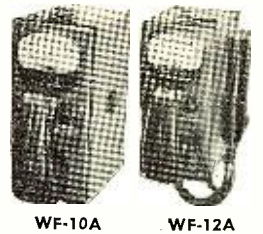

WF-10A WF-12A

16 Watts
Factory Wired Hi-Fi Amp **\$34.95**

Combination offers: Model SL-20 with B-125X speaker board, \$51.95; with new B-250X, 4 speaker board, \$69.95; with Norelco 9762M, \$69.95; with H-4H cabinet speaker system, \$69.95.

New, 1958 model Imperial Slim-Line 16 watt high fidelity amplifier (20 watts peak), with built-in pre-amplifier. Full range audio response from 15 to 22,000 cps. Dual tone controls; full 18 db bass and full 15 db treble boost. Input for radio tuner, tape recorder and phono. Input compensation for the new 1958 model, 4 gram General Electric variable reluctance cartridges, as well as the famous G.E. RPX-050, RPX-052 and RCA 6300A. Compensation for AES and RIAA phono records. A factory built amplifier at less than kit prices. Output impedance matches 8 or 16 ohm high fidelity PM multi-color leatherette covered wood cabinet at no added cost; matches blond or mahogany finish speaker systems. Size: 5 1/4" tall, 11 1/4" wide, 8" front to back. Ship. wt. 15 lbs. Model SL-20 Imperial, List price, \$69.50. McGee's Sale price, \$34.95.

NEW 1958 "COMPLETE HI-FI SPEAKER SYSTEMS IN CABINETS"

The new, 1958 Hollywood 4-speaker systems are designed to give realistic reproduction from your Hi-Fi audio amplifier or FM-AM radio. The new Hollywood Juke Box full bass response. Built-in LC crossover networks. Fully enclosed, acoustically lined. Standard models 35" tall, 19" deep and 25" wide. Deluxe models 37" tall, 21 1/2" wide, 23 1/2" front to back, \$5.00 extra. Choice of Mahogany or Blond finishes. We will ship mahogany unless you specify blond.

MODEL H-4H SYSTEM, \$39.95
Model H-4H, Hollywood, 4-speaker high fidelity speaker system, 20 watts, response 20 to 17,500 cps. Choice of Mahogany or Blond finish enclosure. Features a 12" Diffusion Cone 6.8 oz. Alnico V magnet, aluminum voice coil woofer, plus 6" mid-range and 2-5" tweeters. Built-in variable brilliance LC crossover network. Model H-4H, ship. wt. 55 lbs. Price, \$39.95. Larger deluxe cabinet, \$5.00 extra.

MODEL Z-4Z SYSTEM, \$49.95
Model Z-4Z, Hollywood 4-speaker high fidelity speaker system, 25 watts, response from 18 to 17,500 cps. Choice of Mahogany or Blond finish enclosure. Features a 15" 2 1/2" oz. Alnico V Utah heavy duty woofer, plus 6" mid-range and 2-5" tweeters. Built-in variable brilliance LC crossover network. Model Z-4Z, ship. wt. 57 lbs. Sale price, \$49.95. Larger deluxe cabinet, \$5.00 extra.

Imperial 81 and 91 systems are offered in the larger Blond or Mahogany cabinet. 37" tall, 27 1/2" wide and 23 1/2" front to back. Enclosure is acoustically lined to approach an infinite baffle. Ideal for any Hi-Fi system and priced at worth of speakers alone. LC crossover network and variable brilliance control. Features heavy woofers and horn tweeters.

IMPERIAL 81, \$69.95
25 watts, response 18 to 20,000 cps. A complete speaker system in the above described enclosure, ready to connect to your Hi-Fi amplifier. Built-in LC 2 way crossover network. Speakers included are 15" 2 1/2" oz. Utah woofer, 8" 6.8 oz. mid-range and horn type Pioneer PT-3 tweeter. Model 81, speaker system. Ship. wt. 80 lbs. Sale price, \$69.95.

IMPERIAL 91, \$89.95
Imperial 91, 30 watt speaker system with 5 speakers. Response, 15 to 20,000 cps. A complete speaker system in the above enclosure, ready to connect to the 8 ohm output of your high fidelity amplifier. Includes the 21 oz. Utah 15" woofer, two of the 8", 6.8 oz. mid-range speakers and two of the PT-3 Pioneer horn type tweeters. Built-in LC type, 3 way crossover network. Imperial 91, speaker system. Ship. wt. 90 lbs., Sale price, \$89.95.

TREMENDOUS MCGEE VALUE—NEW 1958 HI-FI SPEAKER SYSTEMS ON BAFFLE BOARDS

Model B-125-X, high fidelity 15-watt, 5-way speaker system, mounted on an 18" square baffle board. Has 12" High Efficiency woofer, 2-4" mid-range speakers, plus 2-5" tweeter; all with Alnico V magnets. Built-in crossover network with variable brilliance control. Y Singera kit, \$18.95. Stock No. B-125-X, 5-way, 15-watt Hi-Fi speaker system. AUDIOPHILE VALUE \$30.00. SALE PRICE \$18.95.

DELUXE HI-FI 25 WATT SPEAKER BOARD \$29.95
Model B-250X, 4 matched Hi-Fi PM speakers mounted on a baffle board, 15" wide and 30" tall. For installation in your own cabinet or play as it comes. Features 15" woofer, 10" mid-range, 5 1/2" and 5" tweeters; built-in proper LC crossover network with variable brilliance control. Includes 11" x 11" x 1 1/2" aluminum cabinet, 18" x 17.5" x 11" deep. Ship. wt. 24 lbs. (not mailable). Model HF-250C Sale price, \$69.95.

World Famous Imported from Holland NORELCO HI-FI PM SPEAKERS

12" Model 9762-M reg. \$59.97 Sale Price \$39.95
12" Model 9760 reg. \$32.97 Sale Price \$19.95
8" Model 9760 reg. \$27.17 Sale Price \$15.95

NORELCO Model 9762-12 wide range Hi-Fi PM speaker, res. 35 to 18,000 cps at 30-watts. Voice coil imp. 8 ohms—new Alnico VI magnet gives 11,000 gauss. Regular \$59.97 net, on sale at McGEE for only \$39.95.

NORELCO Model 9760-12" wide range Hi-Fi PM speaker, res. 35 to 18,000 cps at 30-watts. Voice coil imp. 8 ohms—new Alnico VI magnet gives 11,000 gauss. Regular \$32.97 net, on sale at McGEE for only \$19.95.

NORELCO Model 9750-8" wide range Hi-Fi PM speaker, res. 50 to 20,000 cps at 15-watts. Voice coil 6 ohms—new Alnico VI magnet gives 13,500 gauss. Regular \$22.17 net, on sale at McGEE for only \$15.95; or 2 for \$30.00.

22 TUBE ESPEY FM-AM TUNER-AMPLIFIER SALE \$99.95

Espey Model 700G-501G, complete 14 tube FM-AM tuner and matching 8 tube, 24 watt ultra-linear amplifier. A regular \$199.50 value on sale at McGee for \$99.95. Features AFC on FM. Receives broadcast 550 to 1700 kc and FM, 88 to 108 mc. Built-in preamplifier. Separate bass and treble controls, record equalization. Response, 10 cps to 20,000 cps, auxiliary input jacks. Tuner chassis is 14" long, 8 1/2" high, 10" deep. (Leatherette cabinet for tuner only, \$7.95 extra.) Amplifier 12"x8"x5" (push-pull, parallel 6V6 output tubes). Price includes all tubes, knobs and escutcheon plate. Shipping weight 42 lbs. A true McGee value.

Combination offer with Garrard RC-98 changer and 4G-052 G.E. cartridge, \$174.95, no speaker included. Why not order a Norelco or our new B-250X speaker board with your Espey?

ESPEY 14 TUBE FM-AM WITH BUILT-IN HI-FI AUDIO \$69.95

Espey Model HF-250C, 14 tube FM-AM chassis with push-pull 6V6, 10 watt audio. A true Hi-Fidelity receiver built by a nationally famous maker of fine custom chassis. Ultra-linear type circuit gives frequency response of 10 to 22,000 cps. Output taps of 4, 8 and 16 ohms. Separate RF stages for FM and AM assure high sensitivity. Temperature compensated FM front end for minimum drift. Separate bass and treble tone controls. Pre-amp for all types of magnetic cartridges. 2nd input for crystal phono, tape recorder or TV. 3 position equalizer for accurate reproduction of all records. Built-in antennas for both FM and AM. Response plus or minus 1 db from 10 to 22,000 cps. Harmonic distortion less than 1%. Sensitivity: FM, 100 microvolts; AM, 100 microvolts. Signal to noise ratio. Off-on-volume and equalizer are combined on a concentric control. Has 2 AC outlets on rear of chassis. Beautiful edge lighted flywheel inertia slide 22" x 7 3/4" x 1 1/2" deep. Ship. wt. 24 lbs. (not mailable). Model HF-250C Sale price, \$69.95.

Espey chassis with our P15-CR, 15" coaxial speaker, both \$89.95.
Espey chassis with \$54.95 list, model 9760M, 12" Phillips speaker, both for \$89.95.
Espey chassis with \$99.95 list, model 9762M, 12" Phillips speaker, both for \$104.95.

24 INCH CUSTOM TELEVISION CHASSIS \$129.95

McGee offers this nationally famous make 24" television chassis with aluminumized picture tube and 6V6 Hi-Fi amplifier. Full power transformer operated with switch type cascade tuner. All regular wiring—no printed circuits. Chassis is mounted on a baseboard and shipped with picture tube installed. Area required for chassis; 28" wide, 20" high and 20" front to back. Safety glass size, 23 13/16" x 19 3/4". Tuner and controls are mounted on a separate vertical bracket to make it easy to move when installing. Price includes all tubes and 24" 24YF4 aluminumized picture tube. Knobs and safety glass included. Good quality audio. 2-8" and 2-5" speakers are furnished, mounted on a baffle board 24" x 19 3/4". Stock No. MG75-02, with all tubes and 45 day picture tube warranty. Sale price, \$129.95. Price with one year picture tube warranty, \$133.95.

Stock No. MG75-02-HF10, same as MG75-02 except with push-pull 6V6 Hi-Fi amplifier and with 2-12" PM's and 2-5" tweeters on a baffle board. Sale price, \$149.95.

Stock No. MG75-01, similar in appearance to the 24" model illustrated, except set day picture tube warranty. 1 year picture tube warranty. \$129.95 with 45 day picture tube warranty. 1 year picture tube warranty. \$130 additional.

AUTOMATIC CHANGERS AT LOW PRICES

Special prices on VM 3 speed Hi-Fi record changers. Equipped with plug-in heads. Features 4 pole motor, intermixes 10" and 12" records of the same speed, shuts off after last record has played. Size: 13 1/2" x 13 1/4" x 13 1/4". Ship. wt. 12 lbs. VM-935 and VM-936 are the same changer except the VM-936 is on a base as illustrated. Price includes 45 RPM spindle.

MONARCH UA8H \$27.95
VM-935HF with RPX-050A G.E. VR cartridge, \$29.95.
VM-936HF on base with RPX-050A G.E. VR cartridge, \$32.95. 1 mil diamond needle, \$8.95 extra.

VM-936HF \$32.95

Stock No. MG75-01, similar in appearance to the 24" model illustrated, except set day picture tube warranty. 1 year picture tube warranty. \$129.95 with 45 day picture tube warranty. 1 year picture tube warranty. \$130 additional.

Latest 4 speed English imported Monarch record changer. Features a 4 pole motor, 9" turntable with molded rubber record float. Balanced tone arm readily accepts most makes of Hi-Fi cartridges. Plays 16 2/3, 33 1/3, 45 and 78 RPM records. Intermixes 10" and 12" records of the same speed. Shuts off after last record has played. Compact size, 12 3/4" x 10 3/4" x 10 3/4". Ship. wt. 15 lbs. Large 45 RPM spindle, \$1.88 extra. Choice of mahogany or wood mounting base, \$4.50 extra. Offered with several types of cartridges.

UA8-H with Ronette flip-over Hi-Fi crystal cartridge, \$27.95.
UA8-4G050 with latest General Electric VR cartridge, \$29.95.
UA8-4G052 with latest G.E. cartridge, 1 mil diamond and 3 mil sapphire stylus, \$39.95.

Latest Garrard Renewin II, RC-121 II, latest 1958 Garrard Hi-Fi, 4 speed changer with plug-in head shell, Net \$42.50, with G.E. 4G-050 cartridge, \$51.45, with G.E. 4G-052 cartridge, \$61.80. 45 RPM spindle, \$3.50 extra.

ALLIANCE "IT" T.V. TUNER REMOTE CONTROL \$4.94
REG. \$19.50 LIST

McGee Special Purchase Sale! Alliance "IT" remote tuner for your TV set. A small battery operated motor turns your tuner clockwise or counter-clockwise. Attractive bakelite case fits palm of your hand. Made to sell at over \$12.00 dealers net. McGee's sale price, \$4.94, 3 for \$12.50 with flashlight batteries. Also adaptable to many other uses. Add 40¢ per unit for packing and postage.

3 SPEED HI-FI COLLARO Model RC-54, 3 speed (33 1/3, 45 and 78 RPM) Col- laro record changer. A into mode. High Fidelity record changer with a ceramic crystal cartridge (no pre-amplifier required). Features diamond 1 mil and sapphire 3 mil needle, 4 pole motor. Base size, 12" x 13 1/4". For 110 volt, 60 cycle AC operation. Intended for use by a nationally known Hi-Fi set manufacturer. McGee bought them at a substantial saving. Stock No. RC-54 Collaro changer with crystal cartridge, equipped with diamond 1 mil and sapphire 3 mil needle. McGee Sale Price, \$27.95.

Tan leatherette covered wood base, 13 x 14 1/2 x 3 7/8", shipped separate at \$3.65 extra.

McGEE RADIO COMPANY PRICES F.O.B. KANSAS CITY SEND 25¢ OR FULL REMITTANCE WITH ORDER. TELEPHONE VICTOR 2-5092 1903 MCGEE ST., KANSAS CITY, MISSOURI

HOW TO BUILD A Transistorized 40-watt supply

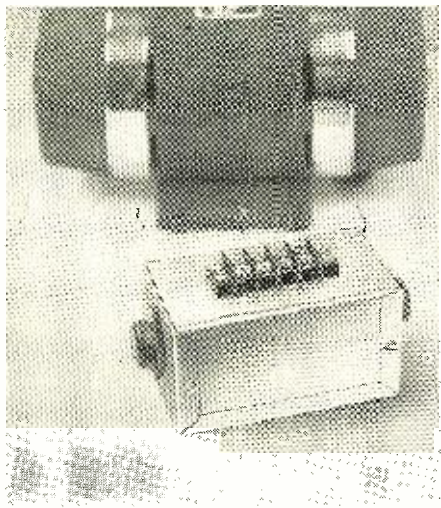

Easy to build, this modern power supply is as big in performance as it is little in size. Two CBS 2N256 power transistors, operating from a 12-volt battery, deliver 450 and 250 volts simultaneously. Combined output is 40 watts continuous service.

Features: compact and light... 85% efficient... instant-starting... cool-running... long-lived. No moving parts... vibrationless, noiseless and troublefree. You'll find this supply ideal for mobile or portable transmitter and/or receiver, sound system, etc.

Free Bulletin E-279 gives complete how-to-build-it details. Get it today with your 2N256 transistors from your CBS Tube distributor.



2N256...\$1.50
2N255...\$1.35

CBS-HYTRON

Semiconductor Operations, Lowell, Mass.
A Division of
Columbia Broadcasting System, Inc.

Within the Industry

(Continued from page 28)

school is housed at 5601 First Avenue, North, Birmingham, Alabama... **EAGLE ELECTRIC MFG. CO., INC.**, Long Island City, N. Y., advises that it has just purchased the entire assets of the **MATOL CORP.** They have also acquired the automatic screw machine department of the **CHASE BRASS & COPPER CO.** and the bottom turn knob socket division of **ALCOR MFG. CO.**

* * *

RICHARD P. GIFFORD has been named manager of engineering for *General Electric Company's* communication products department.



Mr. Gifford will have the responsibility of coordinating the firm's engineering activities in the fields of mobile radio communications, microwave relay, power line carrier current, and terminal equipment.

He joined the company's broadcast engineering section in 1946 and was active later that year as a member of a team of engineers which established the first microwave relay from New York to Schenectady for television transmission purposes. By 1956 he had been promoted to manager of advanced engineering for the company's communication products department and was given responsibility for development of new techniques in the communications art.

Mr. Gifford has been a member of the Electronics Industries Association for the past ten years and a member of the IRE since 1950.

* * *

HUGHES AIRCRAFT COMPANY will grant master of science fellowships to 150 college graduates to help them pursue advanced studies in science and engineering.

Fellows will be selected from applicants with outstanding scholastic records from universities throughout the nation. Those selected will work towards masters degrees at the University of Southern California, University of California at Los Angeles, California Institute of Technology, or the University of Arizona.

* * *

T. B. THOMPSON has been appointed marketing administrator, broadcast equipment group, *RCA Victor Company, Ltd.*, Montreal. At the same time, **D. C. TUCKER** is now marketing administrator of this organization. Mr. Thompson has been with the firm since 1957 and graduated from the University of Toronto with honors in electrical engineering. Mr. Tucker was formerly associated with *Canadian Marconi Company*, Montreal... **THOMAS C. FLYNN** has joined the public relations department of *International Telephone and Telegraph Corp.* as manager of trade press... *General*

Precision Equipment Co. announces the appointment of **EDWIN A. LINK** as president of the firm and his resignation as vice-chairman of the board... **LOYD DOPKINS** is now general sales manager of the *Radio Craftsmen Division of Precision Radiation Instruments, Inc.*... **R. W. (DICK) WALTER** has been named sales manager of the high-fidelity components division of *Thorens Company*... The appointment of two vice-presidents of *Sylvania Electronic Tubes*, a division of *Sylvania Electric Products Inc.*, has been announced. **W. HERBERT LAMB** is vice-president, television picture tubes and **WALTER A. WEISS** is vice-president, radio tubes... **G. J. JANOFF** is now the manager, market planning, entertainment receiving tubes, *RCA electron tube division*... *Sperry Gyroscope Company* has named **E. U. DA PARMA** executive vice-president... **HAL B. AVERY** has been named to the newly created position of sales planning manager, television section, *Hotpoint Company*... The appointments of **LES A. THAYER** as general sales manager and **E. K. (GENE) BUTLER** as manager of marketing services for *Belden Manufacturing Company* have been announced by the firm... **DONALD J. TRICEBOCK** is the new manager of the electronics division, *Diamond Power Specialty Corp.*... **P. R. Mallory & Co. Inc.** has appointed **CHARLES A. BARNES** controller... **KENDALL CLOUGH** has been promoted to the post of director of engineering for the *Paraplegics Manufacturing Company, Inc.*... *Raytheon Manufacturing Company* has appointed **DAVID R. HULL** vice-president for defense programs... Four new executive and sales appointments have been announced by *The Tenna Mfg. Co.* **MORTON MENDES** is promoted to the post of executive vice-president, **HARVEY LUDWIG** is now vice-president in charge of sales and advertising, **STANLEY B. GOSS**, electronic distributors' sales manager, will also handle manufacturers' business, and **MAX BAUER**, a newcomer to the firm, is now assistant sales manager... *Radio Corporation of America* has elected the following three new vice-presidents: **DR. JAMES HILLIER** is now vice-president, *RCA Laboratories*; **RAYMOND W. SAXON** is vice-president and general manager of the radio and "Victrola" division; and **JOSEPH M. HERTZBERG** is vice-president, defense marketing, defense electronic products... **PAUL PETRACK** has been named chief engineer for semiconductors, components division, *International Telephone and Telegraph Corp.*... **C. E. HAMANN** has retired after more than 46 years of service with the *General Electric Company*. He was manager of application engineering and product service for the firm's rectifier department at the time of his retirement... *International Resistance Company* has announced the resignation of **CHARLES H. GRIFFITH**, vice-president of sales... **LOUIS A. DURGIN**, senior engineer at *Allen B. Du Mont Labs., Inc.*, died recently. —30—

Build the Best— build ALLIED knight®-kits

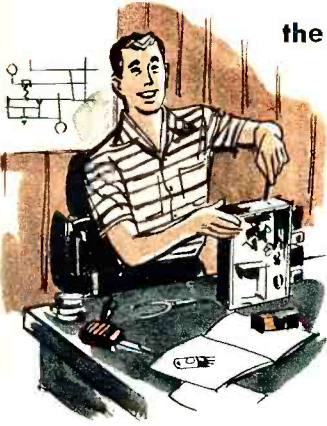

the finest electronic equipment in money-saving kit form

LOWEST COST

ALLIED'S giant buying power passes biggest savings on to you—you do the easy assembly and your finished instrument equals the performance and appearance of equipment selling for several times the low KNIGHT-KIT cost. Your savings are BIG.

EASIEST TO BUILD

KNIGHT-KIT "Step-and-Check" instruction manuals with wall-sized picture diagrams are marvels of clarity—it's like having a good instructor at your side. No experience required—you can easily build any KNIGHT-KIT and get professional results.

LATEST DESIGN

Each ALLIED KNIGHT-KIT incorporates the very latest circuitry for top-quality performance. Tried and proved professional design and the use of premium quality parts throughout help insure your building success to bring you quality results.

COMPLETE KIT SELECTION:

- HI-FI
- HOBBY
- INSTRUMENT
- AMATEUR



MONEYBACK GUARANTEE. When properly assembled, KNIGHT-KITS fully meet published specifications or we refund your money in full.

EASY TERMS. If your KNIGHT-KIT order comes to \$45.00 or more, you can make your purchase on our attractive Easy Payment Plan.

High Fidelity Everyone Can Afford

- World's Finest Hi-Fi Kits
- Custom-Styled
- Easiest to Build Hi-Fi
- Money-Saving



knight-kit High Fidelity FM-AM Tuner Kit

Model Y-787

\$49.95

Only \$4.99 down

- Latest Time-Saving Printed Circuit Design
- Flywheel Tuning
- Automatic Frequency Control
- 2.5 μ v FM Sensitivity
- True High Fidelity Response
- Beautiful Custom-Styled "Space Saver" Case

The best-looking, best-performing FM-AM tuner kit your money can buy! Carefully designed for quick, easy construction—a tuner you'll enjoy assembling and be proud to own, both for its amazing musical performance and outstanding beauty. Covers the full AM broadcast band and 88 to 108 mc FM. On FM, sensitivity is a remarkable 2.5 microvolts for 20 db of quieting; hum and noise, -60 db; IF bandwidth, 200 kc at 50% down on curve; response, \pm 0.5 db, 20-20,000 cps. On AM, sensitivity is 3 microvolts for 10 db signal-to-noise ratio; IF bandwidth, 8 kc at 50% down on curve; response, 20-8000 cps. Outstanding features include: Inertia Flywheel Tuning for effortless, accurate tuning; Automatic Frequency Control (plus AFC disabling) to "lock-in" FM stations; printed circuit board (with most of the kit wiring already done for you) assures time-saving, error-free assembly; pre-aligned RF and IF coils; tuned RF stage on FM; drift-compensated oscillator; neon glow tuning pointer; cathode follower output; two output jacks—one for recorder, one for amplifier; rotatable built-in ferrite antenna for AM. Includes beautiful French-gray case with chrome-finished tapered feet, 4 x 13 x 8". Ideal for use with 18, 20 or 30 watt KNIGHT-KIT amplifiers. Ready for easy assembly. Shpg. wt., 12 lbs.

Model Y-787. FM-AM Tuner Kit. Net only.....\$49.95



knight-kit 18-Watt Complete Hi-Fi Amplifier Kit

Model Y-786

\$39.95

Only \$3.99 down

- The Last Word in Custom Hi-Fi Styling
- Full 18 Watts with Superb Hi-Fi Specifications
- 8 Inputs for Every Desired Signal Source
- Printed Circuit Switch and Printed Circuit Boards
- Full Equalization for All Record Types

Here is a custom-styled, easy-to-build complete Hi-Fi amplifier at a price that defies comparison. Delivers full 18 watts output with wide-range, flat frequency response for true hi-fi reproduction. Features 8 inputs for every possible signal source, including NARTB equalized tape head input. At full 18 watts output, distortion is only 0.5%; uses new RCA 6973 hi-fi output tubes. Frequency response is \pm 1 db, 20-30,000 cps; tape head and magnetic cartridge sensitivity, 5 microvolts for 18 watts output; hum and noise level better than 60 db below 18 watts. Output taps for 4, 8 or 16 ohm speakers. Controls: Input and Record Equalization; Bass Boost and Attenuate; Treble Boost and Attenuate; Volume. Simplest assembly is made possible through the use of an exclusive printed circuit switch and two printed circuit boards—most of the kit wiring is already done for you. With custom-styled French-gray "space-saver" case on tapered feet finished in chrome, 4 x 13 x 8". Complete with case, tubes, all parts, and step-by-step instructions, for easy, error-free assembly. Shpg. wt., 15 lbs.

Model Y-786. 18-Watt Hi-Fi Amplifier Kit. Net only.....\$39.95

EASY TERMS TO FIT YOUR BUDGET. ALLIED KNIGHT-KITS may be purchased under our Easy Payment Plan. Your order need total only \$45.00 or more—only 10% down, small monthly payments thereafter. No red tape—fast handling assured.

Our 37th Year



© Registered Trade-Mark of Allied Radio Corporation

ORDER FROM **ALLIED RADIO** 100 N. WESTERN AVE. • CHICAGO 80, ILL.

www.americanradiohistory.com

Now you can have Custom-Styled Hi-Fi in **ALLIED**



knight-kit 30-Watt Complete Hi-Fi Amplifier Kit

Model Y-762

\$76⁹⁵

Only \$7.69 down

- Full Equalization, $\pm \frac{1}{2}$ db of Recommended Accuracy
- Printed Circuit Switches • Printed Circuit Boards
- 8 Inputs For Every Possible Signal Source
- Full 30 Watts Output • Custom-Styled Beauty

Comparable to the best in Hi-Fi—at far less cost! Deluxe features include: Linear-deluxe Williamson-type circuit for flawless response; equalization for all records within $\frac{1}{2}$ db of recommended accuracy; 2 exclusive new printed circuit switches in preamp section (no complex wiring to do); 3 printed circuit boards for time-saving, error-free assembly; separate, continuously variable Level and Loudness controls; use of premium 12AY7 tube for low noise and hum; DC on all filaments of preamp tubes; exclusive A-AB-B speaker selector switch (use speakers of mixed impedances without mismatch). 8 inputs: Tape Head direct; G.E. and Pickering cartridges; Ceramic cartridge; Microphone; Auxiliary; Tape Preamp; Tuner (with separate Level Set control). Power amplifier response, $\pm \frac{1}{2}$ db, 15-100,000 cps at full 30 watt level; distortion—harmonic, 0.55% at 30 watts—IM, 0.74% at 20 watts. Separate Bass and Treble controls; rumble filter switch; variable damping. Output, 8 and 16 ohms. With smart French-gray cabinet, 4 x 15 x 15". Ready for easy, money-saving assembly. Shpg. wt., 32 lbs.

Model Y-762. 30-Watt Hi-Fi Amplifier Kit. Net only **\$76.95**

knight-kit High Fidelity FM Tuner Kit

Model Y-751

\$38⁹⁵

Only \$3.89 down

- Authentic High Fidelity FM Response
- Flywheel Tuning • Automatic Frequency Control
- Printed Circuit • Pre-Adjusted Coils and IF's
- 4 Microvolt Sensitivity Guaranteed

Here is top value in creative engineering, impressive hi-fi performance and distinctive design—a tuner you'll be proud to build and own. Covers the full FM band, 88 to 108 mc. Features Automatic Frequency Control (with disabling feature) to "lock-in" stations and prevent drift; Inertia Flywheel Tuning for velvet-smooth, accurate station selection; pre-adjusted RF coils; pre-aligned IF's; cascade broad-band RF amplifier; drift-compensated oscillator; neon bulb pointer. All critical wiring is already done for you in the form of a printed circuit board—assembly is simple. Sensitivity is 4 microvolts for 20 db of quieting across entire band; output, 2 volts at 1000 microvolts input; IF bandwidth, 200 kc; response, 20-20,000 cps. with only 0.6% distortion. Output jacks for amplifier and tape recorder; cathode follower output. Ideal for use with the KNIGHT-KIT amplifiers, or any amplifier with phono-tuner switch. Features custom-styled case in French-gray, with tapered chrome-finished feet, 4 x 13 x 8". Includes all parts, tubes and step-by-step instructions for easy assembly. Shpg. wt., 12 lbs.

Model Y-751. Hi-Fi FM Tuner Kit. Net only **\$38.95**

knight-kit Deluxe 3-Way Speaker System Kit

Model Y-937

\$89⁵⁰

Only \$8.95 down

- Pre-Finished "Quik-Craft" Corner Enclosure
- Klipsch Designed and Licensed
- Famous Knight 12" 3-Way Speaker
- Easy to Assemble—Top Hi-Fi Quality
- Choice of Enclosure Finishes

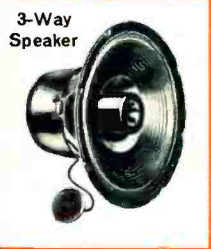

Deluxe quality high fidelity speaker system at a money-saving low price. Easy to assemble—all you need is a screwdriver. System includes KNIGHT "Quik-Craft" corner-type folded-horn enclosure kit, and the famous-value KNIGHT 3-Way 12-inch speaker. Just assemble the enclosure—no finishing required—all surfaces are finished in hand-rubbed Korina blonde, mahogany or walnut. The speaker is the new 3-way type: 12" woofer cone for bass (full $1\frac{3}{4}$ pound woofer magnet), conical radiator for mid-frequencies, built-in compression-type tweeter (with wired level control and calibrated dial) for highest frequencies. Unexcelled enclosure efficiency and superb speaker performance combine to cover the whole spectrum of audible sound for true hi-fi response from 35 to 15,000 cps, ± 3 db. Kit includes 12" 3-Way speaker, prefinished enclosure panels, grille cloth, hardware and instructions. Specify Korina blonde, mahogany or walnut when ordering. Shpg. wt., 44 lbs.

Model Y-937. 3-Way Speaker System Kit. Net only **\$89.50**

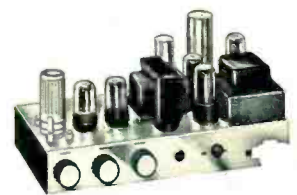

knight-kit 10-Watt Hi-Fi Amplifier Kit

Y-753

\$23⁵⁰

\$2.35 down

Low-cost, authentic hi-fi amplifier. Response, ± 1 db, 30-20,000 cps. Input for crystal phono or tuner; chrome-plated chassis is punched for preamp kit below, to permit use of magnetic phono. Only 0.5 volt drives amplifier to full output. Separate bass and treble controls. Only 1% harmonic distortion. Matches 8-ohm speaker. 7 x 13 x 6". With all parts, tubes and instructions. Shpg. wt., 13 lbs.

Model Y-753. Net only... **\$23.50**
Y-235. Preamp Kit..... **\$ 3.10**
Y-757. Metal Cover..... **\$ 3.95**

ALLIED RADIO America's Pioneer in Electronic Kits

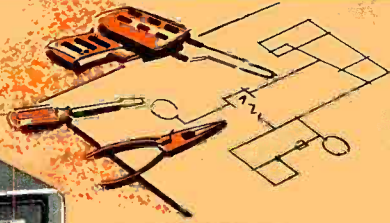

So Easy To Build
Anyone can build
KNIGHT-KIT HI-FI.
No experience re-
quired to get top
results!



knight-kit High Fidelity Preamp Kit

Model Y-754

\$39.95

Only \$3.99 down

- Exclusive Printed Circuit Switches and Boards
- Equalization $\pm \frac{1}{2}$ db of Recommended Accuracy
- 8 Inputs Including Tape Head
- Self-Powered
- DC on All Tube Filaments
- Custom-Styled

Sensational Hi-Fi design at amazing low cost. Provides precise record equalization guaranteed within $\frac{1}{2}$ db of recommended accuracy!—more accurate than all but the most expensive factory-built preamps. Includes exclusive new KNIGHT-KIT printed circuit switches for easy, error-free assembly; 2 printed circuit boards eliminate all other wiring, except for power supply and control leads—so easy to build. Has built-in power supply; includes premium 12AY7 and ECC82 tubes. Frequency response, ± 0.5 db, 10-50,000 cps. Has 8 inputs: Tape Head; G.E. Phono; Pickering Phono; Ceramic; Microphone; Auxiliary; Tape Preamp; Tuner. Level adjustment for tuner input. Includes separate Bass and Treble controls; separate Level and Loudness controls; Rumble Filter switch; DC on all tube filaments; cathode follower output; 2 extra AC outlets. You get every advanced hi-fi feature in this easy-to-build preamplifier at the lowest possible cost. Includes beautiful custom-styled French-gray case, with tapered chrome-finished legs, 4 x 13 x 8". With all parts, tubes, step-by-step instructions; ready for easy assembly. Shpg. wt., 12 $\frac{1}{2}$ lbs.

Model Y-754. Hi-Fi Preamp Kit. Net only **\$39.95**

knight-kit 25-Watt Hi-Fi Basic Amplifier Kit

Model Y-755

\$44.50

Only \$4.45 down

- Hi-Fi Response, ± 0.5 db, 10 to 120,000 cps
- Only 0.15% Distortion at 30 Watts Output
- Printed Circuit Wiring Board • Chrome-Plated Chassis
- Williamson-Type Circuit with Over 25 Watts Output

Here's superb Hi-Fi performance at less than half the cost of a comparable commercially-assembled unit. Williamson-type linear-deluxe circuit delivers over 25 watts of virtually undistorted reproduction. Ideal for use with the KNIGHT-KIT preamp at left. Includes printed circuit board for simplified, error-free assembly. Remarkable hi-fi response, ± 0.5 db, 10-120,000 cps at 20 watts. Harmonic distortion, 0.15% at 30 watts; IM, 0.4% at 20 watts. Hum level, 85 db below 25 watts output. Output impedances, 4, 8 and 16 ohms; output tubes, 2-5881. Includes balance control for precise matching of the output tubes; variable damping control for maximum performance with any speaker system—prevents low-frequency distortion from overdamping or underdamping. Very attractive black and chrome styling, 6 $\frac{1}{4}$ x 14 x 9". An outstanding engineering achievement in a basic hi-fi amplifier, delivering performance equal to the finest commercially assembled units. Includes all parts and tubes; with step-by-step instructions, ready for easy assembly. Shpg. wt., 25 lbs.

Model Y-755. 25-Watt Amplifier Kit. Net only **\$44.50**
Y-759. Metal Cover for above; black finish. 5 lbs. Net **\$4.25**



knight-kit 20-Watt Hi-Fi Amplifier Kit

Y-750

\$35.75

Only \$3.57 down

True hi-fi for less! Complete with full set of controls and built-in preamplifier. Response, ± 1 db, 20-20,000 cps; distortion 1% at 20 watts. Inputs for magnetic phono, microphone, crystal phono or recorder, and tuner. Compensation positions for 78 and LP records. Separate bass and treble controls. Output impedances, 4, 8, 16 and 500 ohms. Chrome-plated chassis. 7 x 13 x 8 $\frac{3}{4}$ ". Ready for easy assembly. Shpg. wt., 20 lbs.

Model Y-750. Net only **\$35.75**
Y-758. Metal Cover **\$4.15**

knight-kit 2-Way Hi-Fi Speaker System Kit

Model Y-789

\$49.95

Only \$4.99 down

- Easy to Assemble—Pre-Finished Enclosure
- High Fidelity Response, 45 to 14,000 cps
- 12" Woofer and Horn-Type Tweeter
- A Wonderful Money-Saving Speaker Value

BIG SAVINGS—assemble your own quality KNIGHT-KIT 2-way speaker system—it's quick and easy! The cabinet is *pre-finished* in full-grained, high luster blonde or mahogany—you just assemble 7 pieces, mount the speaker components and enjoy rich, thrilling hi-fi sound—at incomparably low cost. Special Jensen-engineered baffle features "ducted port" construction to bring out the full beauty of bass notes, perfectly matching the Jensen woofer and compression tweeter; genuine L-pad control is rear-mounted to permit adjustment of tweeter for best tonal balance. Impedance, 16 ohms. The assembled unit delivers a frequency response of 45 to 14,000 cps. Enclosure measures 26 x 19 x 14". Beautifully styled to blend in any room. Kit includes Jensen 12" woofer, Jensen compression-type tweeter, pre-finished wood parts (with grille cloth installed), acoustic material, glue, hardware and step-by-step instructions. Absolutely no furniture finishing required. *Specify blonde or mahogany finish when ordering.* Shpg. wt., 33 lbs.

Model Y-789. 2-Way Speaker System Kit. Net only **\$49.95**



12" Woofer
Tweeter with Controls

Fascinating

ALLIED **knight-kits**

FOR EXPERIMENTERS AND HOBBYISTS

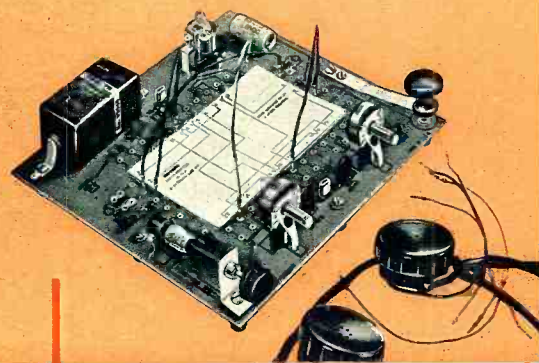
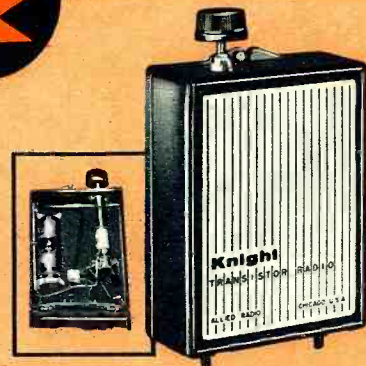

knight-kit 2-Transistor Pocket Radio Receiver Kit

Model Y-262 • Loud, Clear Local Reception
 • Newest Printed Circuit Board
 • Built-In Loop Antenna
 • Complete Kit—Nothing Else To Buy

\$14.65

It's fun to build this pocket-size two-transistor radio—and you'll enjoy its crystal-clear local broadcast-band reception wherever you go! Fits in your pocket, or with its button-down flap, can be worn from your belt. Completely self-contained with built-in ferrite loopstick antenna—no external antenna needed. Extremely efficient reflex type 2-transistor circuit actually does the work of 3 transistors! Printed circuit board reduces building time to about one hour. Has air-dielectric variable capacitor for easy, accurate station tuning. Operates for months and months on long-life alkaline battery supplied. Sensitive miniature earpiece provides crystal-clear tone. Handsome tan carrying case, plastic-impregnated, is styled to resemble leather; only 4x3 3/4 x 1 1/4". Kit includes all parts, transistors, earpiece, battery and case. Shpg. wt., 1 1/2 lbs.

Model Y-262. Net only \$14.65

knight-kit "Trans-Midge" Transistor Receiver Kit

Model Y-767 Tiny, cigarette-pack-size one-transistor radio kit—fascinating to build—so low-priced. This novel miniature receiver will provide endless listening

pleasure the moment assembly is completed. Covers the local AM broadcast band with exceptional sensitivity and selectivity. Special features include: Efficient, slug-tuned coil for excellent station separation; external knob for easy station tuning; low-drain transistor operating for months from single penlight cell supplied; hinged-back, red plastic case. Kit includes all parts, transistor, battery, compact case and easy-to-follow instructions for quick assembly. (External antenna and headphones required.) Shpg. wt., 8 oz.

Model Y-767. Net only \$2.45
J-149. 4000 Ohm Headphones. 1 lb. \$2.15
C-100. Antenna Kit. 1 1/2 lbs. \$1.03

knight-kit 10-Circuit Transistor Lab Kit

Model Y-299 Sensational experimenters' transistor kit—an electronic marvel! Perfect for experimenter, student or hobbyist.

\$15.75

Assemble basic parts once, then complete project after project (10 in all), by simply plugging leads into proper jacks on printed circuit board—no wiring changes needed. You learn how transistors operate by "plugging in" to make any one of the following circuits; AM radio for strong headphone reception; 2-stage audio amplifier; wireless broadcaster; code practice oscillator; electronic timer; electronic switch; electronic flasher; photoelectronic relay; voice-operated relay; capacity-operated relay. Includes all parts, 2 transistors, battery, headphones, circuit leads, relay, photocell, special guide cards for each project, explanation of each circuit. 3 lbs.

Model Y-299. Net only \$15.75

knight-kit 5-Transistor Superhet Personal Portable Radio Kit

Model Y-766 • Styled to Equal the Finest
 • Push-Pull Audio Drives 3 1/2" Speaker
 • Printed Circuit for Easy Building
 • 200 Hour Battery Playing Life

\$29.95

Beautiful, easy-to-build transistorized personal portable with every ultra-modern design feature: 5 Texas Instrument Co. transistors; latest printed circuit chassis for easy, error-free assembly; bigger-than-average 3 1/2" speaker; class B push-pull audio output; built-in high-gain ferrite loopstick antenna; plus phone jack output for private listening. Provides sensitive reception of the AM broadcast band with exceptional tone quality. Ultra-smart high-impact ivory plastic case has handsome gold trim with ebony accents; includes pull-out handle; only 7 1/2 x 3 3/8 x 1 3/4". With all parts, transistors, 9 volt transistor radio battery, carrying case and instructions anyone can easily follow. Shpg. wt., 2 lbs.

Model Y-766. Net only \$29.95

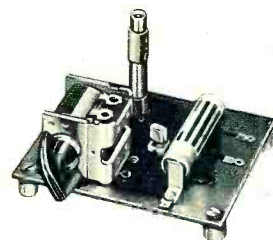

1-Transistor Radio Kit

\$3.95 Offers excellent AM local broadcast headphone reception. Printed circuit board for easy assembly. Operates from single penlight cell for months. Complete with all parts, transistor and penlight cell. (Antenna and headphones required.) Shpg. wt., 1 lb.
Model Y-765. Net only \$3.95



"10-In-One" Electronic Lab Kit

\$12.65 Famous experimenters' kit. Builds any of 10 fascinating projects, including broadcast receiver, wireless phono oscillator, code practice oscillator, signal tracer, relays, etc. Shpg. wt., 5 lbs.
Model Y-265. Net only \$12.65

"6-In-One" Electronic Lab Kit

\$8.45 A favorite with beginners. After basic wiring is completed, you make circuit changes without soldering. Builds any of six favorite projects, including radio, wireless broadcaster, etc. Shpg. wt., 3 lbs.
Model Y-770. Net only \$8.45

Crystal Set Hobby Kit

\$2.15 Entertaining, educational. Delivers clear headphone reception of local broadcast stations. With all parts, ready for easy assembly. (Antenna and headphones required.) Shpg. wt., 1 lb.
Model Y-261. Net only \$2.15

Wireless Broadcaster Kit

\$9.50 Play music or make announcements through your radio set—no connection to set required! Loads of fun—easy to build. Works up to 50 feet from set. Shpg. wt., 3 lbs.
Model Y-705. Net only \$9.50

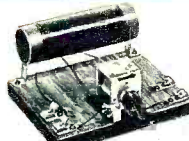

ORDER FROM **ALLIED RADIO** 100 N. WESTERN AVE. • CHICAGO 80, ILL.

www.americanradiohistory.com

FUN TO BUILD . . . INSTRUCTIVE . . . LATEST CIRCUITS FOR TOP PERFORMANCE
WIDEST CHOICE OF QUALITY HOBBYIST KITS



Interruption of light beam triggers relay, which in turn sounds chime or bell, turns on lights, etc.



knight-kit Photoelectronic Relay Kit

Model Y-702 Advanced-design, ultra-sensitive photoelectronic relay—build it yourself and save! Dozens of uses: for automatic control of lights, door announcer, burglar alarm, counting devices, etc. Provides dependable operation up to 250 feet with white light, up to 125 feet with "unseen" light (red filter) from Light Source Kit listed below. Selectable operation, with "trip" for burglar alarm to provide continuous ringing of alarm; and "auto" if relay is to operate each time beam is broken (for chimes, counting devices, turning on lights at darkness). Has SPST relay operated from thyatron; 6.3 v. terminals provide power for accessories. For 105-120 v. 50-60 cy. AC use. 6 lbs.

Model Y-702. Relay Kit. Net only. **\$13.50**

Model Y-703. Light Source Kit. With bulb and red filter. Shpg. wt., 3½ lbs. Net. **\$6.75**

knight-kit "Ocean Hopper" All-Wave Radio Kit

Model Y-740 This top-performing regenerative receiver puts a world of listening pleasure at your finger-tips. Tuning range (using coils listed below) is virtually world-wide; covers 155 kc to 35 mc, including every type of radio transmission: AM broadcast, marine, aircraft, distress channels, direction-finding, Amateur, frequency standard, foreign broadcast, and police. With bandspread tuning. For use with headphones or 3-4 ohm PM speaker. Kit is supplied with standard broadcast band coil and all tubes and parts. (Less extra coils, headphones, speaker and cabinet.) Shpg. wt., 5 lbs.

Model Y-740. Net only. **\$11.95**

Y-746. Cabinet for above. 1½ lbs. Net **\$2.90**
 Extra coils available: Long Wave Coil (155-470 kc), Net 79c. Short Wave (1.65—4.1 mc; 2.9—7.3 mc; 7—17.5 mc and 15.5—35 mc), Each 65c.

knight-kit "Space-Scanner" Bandswitching World-Wide Radio Kit

Model Y-243

- Broadcast or Short Wave Reception
- Sensitive Regenerative Circuit
- Convenient Bandspread Tuning
- Built-In Loudspeaker

\$15.95

Imagine the thrill of hearing overseas broadcasts on a precision receiver you've built yourself—and then, at the flip of a switch, being able to tune to your favorite local broadcast station! Bandswitch selects exciting short wave, including foreign broadcasts, amateur calls, aircraft, police and marine radio on the 6.5 to 17 mc range, as well as standard 540-1700 kc broadcasts. Features highly sensitive regenerative circuit. Includes built-in 4" PM speaker and beam-power tube for strong volume and clear tone. Headphone connectors are available for private listening; switch cuts out speaker. Controls: Bandspread, Main Tuning, Antenna Trimmer, Bandswitch, Regeneration, Volume. 7x10x6". Easy to build from step-by-step instruction manual. For 110-120 v., 50-60 cy. AC or DC. (Less cabinet.) Shpg. wt., 5 lbs.

Model Y-243. Net only. **\$15.95**

Y-247. Cabinet for above. Shpg. wt. 2 lbs. Net. **\$2.90**



"Ranger II" Superhet Receiver Kit

\$17.25 Popular Broadcast band receiver built and enjoyed by thousands. Features built-in antenna, automatic volume control, ball-bearing tuning condenser, PM dynamic speaker. Handsome plastic cabinet. Easy to assemble. AC or DC operation. Shpg. wt., 8 lbs.

Model Y-735. Net only. **\$17.25**

knight-kit 2-Way Intercom System Kit

Model Y-295

- Low Cost—Easy to Assemble
- High Gain—Clear Tone
- Handsome Metal Cabinets
- Includes 50-Foot Cable

\$14.75

Easy to build at lowest cost—ideal for home, office, shop or school. Consists of Master unit and Remote unit. Remote unit may be left "open" for answering calls from a distance, for "baby sitting", etc. Remote also may be set for "private" operation—cannot be "listened-in" on, but it can be called and can originate calls. Master unit includes high-gain 2-stage amplifier, combination volume control and on-off switch, plus pilot light. Each unit has 4" PM dynamic speaker. System responds to even a whisper. Handsome Antique white cabinets, each 4¾x6½x4¾". With all parts, tubes and 50-ft. cable (up to 200-ft. may be added). For 110-120 v., AC or DC. 8 lbs.

Model Y-295. Master and one Remote. Net only. **\$14.75**

Y-296. Extra Remote Station Kit. 3 lbs. **\$3.75**

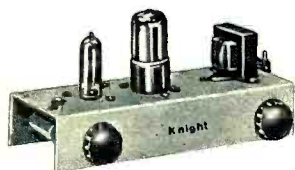
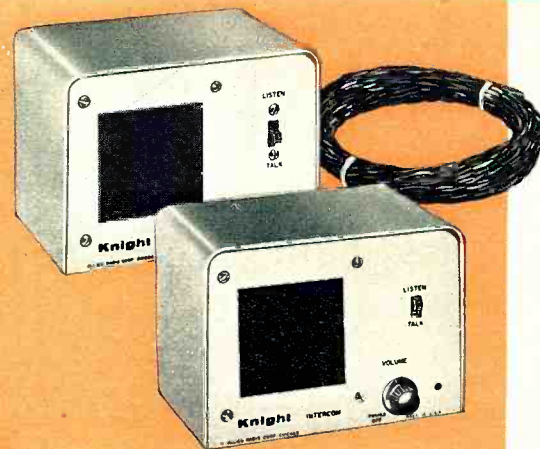

Phono Amplifier Kit

\$9.45 Build it yourself—and save! Ideal for use in a portable phonograph—just add record player and 3-4 ohm speaker. 1½ watts output. Inverse feedback circuit. Easy to assemble. Shpg. wt., 3 lbs.

Model Y-790. Net only. **\$9.45**



Electronic Photoflash Kit

\$28.50 Ideal for color or black and white photography. 1/700th-of-a-second flash; 50 watt/second output. Synchronizes with any camera with X or O shutter. (Less battery.) Shpg. wt., 4 lbs.

Model Y-244. Net only. **\$28.50**



Code Practice Oscillator Kit

\$3.95 Ideal for beginners learning the code. Transistorized circuit. Operates for months from single penlight cell supplied. Clear, crisp 500 cycle tone. Jacks for headphones; screw terminals for key. 1 lb.

Model Y-239. Net only. **\$3.95**



Phono Oscillator Kit

\$5.85 "Broadcasts" recorded music through any standard radio set up to 50 feet away. No direct connection to set required. Easy to build—fun to use. Shpg. wt., 2 lbs.

Model Y-760. Net only. **\$5.85**



knight-kit Low-Cost Tube Tester Kit

- Model Y-143**
- With 16 Filament Voltages
 - 600 Latest Tube Types Listed
 - Easy-to-Read 4½" Meter
 - Tests Series-String TV Tubes
- \$29.75**

Expertly designed for complete, up-to-date coverage of tube types. Tests series-string TV tubes; tests 4, 5, 6 and 7 pin large, regular and miniature types, octals, loctals, 9-pin miniatures and pilot lamps. Tests for open, short, leakage, heater continuity and performance (by amount of cathode emission). Big 4½" square meter has clear "GOOD-?-REPLACE" scale. With line-voltage indicator and line-adjust control. Choice of 16 filament voltages from 0.63 to 117 volts to check virtually all receiving tubes; blank socket for future type tubes. Universal-type selector switches permit selection of any combination of pin connections. Single-unit, pre-assembled 10-lever function switch simplifies and speeds assembly. Up-to-date illuminated roll chart lists over 600 tube types. Counter model case, 5 x 14 x 10". Easy to build. 14 lbs.

- Model Y-143.** Net only **\$29.75**
Y-142. Portable Case model. 15 lbs. Net **\$34.75**
Y-141. Picture Tube Adapter. 1 lb. Net **\$ 4.25**

knight-kit RF Signal Generator Kit

- Model Y-145** Build this wide-range, extremely stable RF signal generator—save two-thirds the cost of a comparable wired instrument! Large, semi-circular dial is clearly calibrated; range is covered in 5 separate bands for close accuracy in setting individual frequencies. Ideal for aligning RF and IF stages in radio and TV sets and for troubleshooting audio equipment. Delivers output on fundamentals from 160 kc all the way out to 112 mc; useful harmonics to 224 mc. Has built-in 400-cycle sine-wave audio oscillator for modulating RF; audio is also available externally. Features high-stability Colpitts circuit. Convenient jack for external modulation. Maximum audio output 10 volts; RF output over 0.1 volt on all ranges. Step and continuous-type attenuator controls. Supplied with precision-wound coils that require no adjustment. 7 x 10 x 5". Shpg. wt., 11 lbs.
- Model Y-145.** Net only **\$19.75**

knight-kit 1000 Ohms/Volt VOM Kit

- Model Y-128** Exceptional accuracy and versatility at amazing low cost. Ideal for service shop, lab or Amateur use. Large 4½", 400 microamp meter with separate scales for AC and DC voltage and current, decibels and resistance. Uses 1% precision resistors; has 3-position function switch and 12-position range switch. 38 ranges include: AC, DC and output volts, 0-1-5-10-50-500-5000 (1000 ohms/volt sensitivity); Resistance, 0-1000-100,000 ohms and 0-1 meg (center scale readings of 60, 150 and 1500 ohms); Current, AC or DC, 0-1-10-100 ma and 0-1 amp; Decibels, -20 to +69 in 6 ranges. Precision resistors are used as shunts and multipliers to assure exceptional accuracy of measurements. With all parts, battery, test leads and black bakelite case with convenient carrying handle, 6¾ x 5¼ x 3¾". A great value in an easy-to-build quality instrument. Shpg. wt., 2½ lbs.
- Model Y-128.** Net only **\$16.95**

knight-kit Vacuum Tube Voltmeter Kit

- Model Y-125**
- 200 µa Movement, 4½" Meter
 - Includes AC, Peak-to-Peak
 - Balanced-Bridge, Push-Pull Circuit
 - 1% Film-Type Resistors
- \$24.95**

Top buy in an extremely stable, highly accurate VTVM. Easy to assemble—entire chassis is printed circuit board. Perfect for radio-TV service work, lab and Amateur use. Features low-leakage type switches; 1% film-type precision resistors; balanced-bridge, push-pull circuit (switch to any range without readjusting zero set); zero center scale and direct-reading db scale; polarity reversing switch. Ranges: Input Resistance, 11 megs; DC and AC rms, 0-1.5-5-15-50-150-500-1500; AC Peak-to-Peak, 0-4-14-40-140-1400-4000; Response, 30 cycles to 3 mc; Ohms, 0-1000-10K-100K and 0-1-10-100-1000 megs; db, -10 to +5. Includes all parts, tubes, battery, test leads and portable case, 7¾ x 5¼ x 4-3/16". Easy to assemble. Shpg. wt., 6 lbs.

- Model Y-125.** Net only **\$24.95**
Y-126. Hi Voltage Probe; extends DC to 50,000 v **\$ 4.75**
Y-127. Hi-Frequency Probe; extends AC to 250 mc **\$ 3.45**



- 6V-12 Battery Eliminator Kit**
- \$32.95** High current rating; continuously variable filtered output; delivers 15 amps at 6 volts, 10 amps at 12 volts. May be used as battery charger. Two meters provide simultaneous current and voltage readings. Shpg. wt., 18 lbs.
- Model Y-129.** Net only **\$32.95**



- Transistor Checker Kit**
- \$8.50** Checks gain ratio of all types of transistors; checks germanium and silicon diodes; checks for continuity and shorts. A valuable instrument at very low cost. Easy to assemble. Shpg. wt., 2½ lbs.
- Model Y-149.** Net only **\$8.50**



- Flyback Checker Kit**
- \$19.50** Checks condition of all types of horizontal output transformers and deflection yokes, as well as TV linearity and width coils. 4½" meter; widest range in its field. Shpg. wt., 6 lbs.
- Model Y-118.** Net only **\$19.50**



- Sweep Generator Kit**
- \$43.75** Extreme linearity on a par with costly lab instruments; fundamentals to 250 mc; output flat within 1 db; electronic blanking. Easy, money-saving assembly. Shpg. wt., 16 lbs.
- Model Y-123.** Net only **\$43.75**



- Capacitor Checker Kit**
- \$12.50** Tests capacitors while in the circuit! Has widest range—20 mmf to 2000 mfd. Exclusive circuit for cancelling lead capacity. "Magic Eye" indicator. Save 60% over factory-wired units. 5 lbs.
- Model Y-119.** Net only **\$12.50**

ADVANCED-DESIGN INSTRUMENTS FOR SERVICE, INDUSTRIAL AND RESEARCH USE IN EASIEST-TO-BUILD, MONEY-SAVING KIT FORM



knight-kit 20,000 Ohms/Volt VOM Kit

Model Y-140 Outstanding quality and performance at money-saving low price. Features 1% precision multipliers; 4½" meter accurate within 2% of full scale deflection; 50 microamp sensitivity for 20,000 ohms/volt input resistance on DC; front panel "Zero adjust"; single switch to select function and range. 32 ranges: AC, DC and output volts, 0-2.5-10-50-250-1000-5000; Resistance, 0-2000-200,000 ohms and 0-20 meg.; DC ma, 0-0.1-10-100; DC amps, 0-1-10; Decibels, -30 to +63 in six ranges. Moisture-resistant film-type resistors for extreme accuracy. Carefully engineered circuit design achieves high sensitivity and extremely versatile application. Kit includes all parts, battery, test leads and black bakelite case with highly legible white markings; size 6¾ x 5¼ x 3¾". Easy to assemble. Shpg. wt., 5 lbs.

Model Y-140. Net only \$29.50

knight-kit High-Gain Signal Tracer Kit

Model Y-135 A remarkable value in an easy-to-build instrument which permits visual and aural signal tracing of RF, IF, video and audio circuits. Has *highest gain in its price class*. Traces signal from antenna to speaker. Reproduces signal at plate or grid connection of any stage. Identifies and isolates "dead" stages. Features: usable gain of 91,000; "magic eye" with calibrated attenuators for signal presence indication and stage-by-stage gain measurements; built-in 4" PM speaker; combination 2-position probe, one for RF (6 mmf. input), the other for audio. Provides noise test; built-in watt-meter calibrated from 25 to 1000 watts; provision for external scope or VTVM. Binding posts provide output transformer and speaker substitution test, plus external 280 volts B+. With all parts, tubes and probe. 7x10x5". 12 lbs.

Model Y-135. Net only \$26.50

knight-kit 5" Wide-Band Oscilloscope Kit

- Model Y-144**
- 5 mc Width for Color TV
 - Horizontal Sweep to 600 kc
 - 25 mv/inch Sensitivity
 - Z-Axis Input
 - Printed Circuit Construction

Only \$6.90 down

Equals or betters the performance of commercially wired scopes costing far more. Two printed circuit boards and laced wiring harness assure wiring accuracy and cut assembly time. Ideal for lab use, color TV servicing and high frequency applications. Wide sweep range—15 to 600,000 cps. Vertical response, ± 3 db, 5 cps to 5 mc; only 1 db down at 3.58 mc color burst. High vertical sensitivity of .025 rms v/inch. Input capacity, 20 mmf. Outstanding features: cathode follower inputs; 2nd anode provides 1400 volts high-intensity trace; push-pull amplifiers; positive and negative locking; frequency-compensated attenuator; Z-axis input; one volt P-P calibrating voltage; astigmatism control; retrace blanking circuit; DC positioning control. Includes CRT. 14½ x 9½ x 16". 40 lbs.

Model Y-144. Net only \$69.00
Y-148. Demodulator Probe. Net \$ 3.45
Y-147. Low Capacity Probe. 12 mmf. Net \$ 3.45



Voltage Calibrator Kit

\$12.75 Permits use of any scope as precision peak-to-peak AC voltmeter. Puts a true square-wave voltage on scope screen. Selects any voltage between .01 and 100 volts; feeds external signal direct to scope for instant comparison. Shpg. wt., 5 lbs.

Model Y-136. Net only \$12.75

knight-kit 5" General-Purpose Scope Kit

- Model Y-146**
- Phantastron Linear Sweep
 - 25 mv/inch Sensitivity
 - Printed Circuit Board
 - Retrace Blanking Circuit

\$42.00

Only \$4.20 down

Feature for feature the world's best oscilloscope kit value. A stand-out in its class with all these fine features: *Printed Circuit* wiring board and laced harness for quick, error-free assembly. *Phantastron Sweep Circuit* for high linearity of sweep from 15 to 150,000 cps. *25 Millivolts Per Inch Sensitivity*—3 times that of similarly priced scope kits. *Calibration Voltage*—1 volt peak-to-peak square wave, fully regulated. *Vertical Amplifier*—frequency response ± 3 db, 3 cps to 1.5 mc (± 6 db to 2.5 mc). Includes: Directly coupled positioning controls; retrace blanking circuit; frequency-compensated vertical input attenuator; positive and negative internal sync; high 2nd-anode voltage for high-intensity trace; input capacity, 45 mmf. Kit includes CRT. 9½ x 13¾ x 17¾". 26 lbs.

Model Y-146. Net only \$42.00



Resistance Substitution Box

\$5.95 Easily determines resistor values required in a circuit. Makes available 36 standard 1-watt resistance values in 2 ranges between 15 ohms and 10 megohms, with 10% accuracy. Slide switch selects range; 18-position switch for value selection. Shpg. wt., 2 lbs.

Model Y-139. Net only \$ 5.95

Capacitance Substitution Box

\$5.95 Makes it easy to find capacitor values needed in a circuit. Provides 18 standard values from .0001 mfd to .22 mfd, ± 20%. All values are 600 volt, except .15 and .22, which are 400 volt. 18-position selector switch. Shpg. wt., 2 lbs.

Model Y-138. Net only \$ 5.95



Audio Generator Kit

\$31.50 Excellent design; range, 20 cps to 1 mc; less than .25% distortion; 600 ohm output. Ideal for hi-fi testing; offers the flat response of a lab standard. Shpg. wt., 16 lbs.

Model Y-137. Net only \$31.50



R/C Tester Kit

\$19.50 Measures capacitance and resistance. Balanced-bridge circuit; indicates power factor; tests capacitors at rated voltage. Large, easy-to-read dial and "magic eye." Shpg. wt., 10 lbs.

Model Y-124. Net only \$19.50

EASY TERMS AVAILABLE

Take advantage of the most liberal Easy Pay plan in electronics. On Knight-Kit orders totaling \$45 or more—just 10% down, small monthly payments thereafter. Low carrying charges—no "red tape."

www.americanradiohistory.com



knight-kit All-Band Amateur Receiver Kit

Model Y-726

\$104⁵⁰

Only \$10.45 down

- Tunes 540 kc to 31 mc
- Built-In Q-Multiplier
- Constant Running HF Oscillator
- Worthy of the Advanced Ham Operator
- Printed Circuit Bandswitch
- Printed Circuit Board • 1.5 μ v Sensitivity

A sensational communications receiver value with all the selectivity, sensitivity and features of high-priced commercial units. Uses printed circuitry throughout, including the exclusive new KNIGHT-KIT printed circuit band-switch, for remarkably easy assembly. Covers 540 kc to 31 mc in 4 ranges; calibrated, electrical bandspread on 80-10 meter Ham bands; slug-tuned Hi-Q coils; continuous, VR tube-regulated B+ applied to HF oscillator lets you switch from standby to receive with no drift; built-in Q-multiplier peaks desired signal or nulls interference; delayed AVC; provision for crystal calibrator (below). Sensitivity, 1.5 microvolts for 10 db signal-to-noise ratio. Selectivity: variable from 300 cps to 4.5 kc at 6 db down. Exalted BFO injection. Controls: Main tuning, bandspread, band selector, Q-multiplier selectivity, Q-multiplier tune, null-off-peak, BFO pitch, RF gain, AF gain, BFO-MVC-AVC-ANL, off-stby-rec-cal, antenna trimmer, and phone jack. Cold-rolled $\frac{1}{16}$ " steel chassis. Handsome metal cabinet, 10 x 10 x 16 $\frac{1}{2}$ ". (Less phones, 8-ohm loudspeaker and S-meter.) 23 lbs.

Model Y-726. Amateur Receiver Kit. Net. . . . \$104.50
 Y-727. S-Meter Kit for above. 1 lb. Net. . . . \$9.50

knight-kit 100 Kc Crystal Calibrator Kit

Model Y-256

\$10⁵⁰

Crystal frequency standard at very low cost. Gives marker every 100 kc up to 32 mc. A "must" for marking band edges. Mounting flanges for installation in or back of receiver cabinet. Size only 1 $\frac{1}{2}$ x 1 $\frac{1}{2}$ x 3". Requires 6.3 v. at 0.15 amp and 150-300 v. DC at 3-6 ma. Trimmer for zero-beating with WWV; On-Off switch. Complete with tube, crystal, all parts and easy-to-follow instructions. Shpg. wt., 1 lb.

Model Y-256. 100 Kc Crystal Calibrator Kit. Net only. . . . \$10.50



knigh -kits FOR THE RADIO AMATEUR

knight-kit 50-Watt CW Transmitter Kit



Model Y-255

\$38⁹⁵

Only \$3.89 down

- Ideal for the Novice
- Pi Antenna Coupler
- Bandswitching—80 to 10 Meters

There's exceptional value in this very popular bandswitching transmitter kit. Compact and versatile, it's the perfect low-power rig for the beginning novice as well as the seasoned veteran. Has bandswitching coverage of 80, 40, 20,

15 and 10 meters. Rated at 50 watts—actually operates at up to 60 watts on 80 and 40 meters. Oscillator is efficient 6AG7; final is reliable 807. Crisp, clean, cathode keying of oscillator and final. Built-in pi coupler permits use with random length antennas. Has highly effective TVI suppression. Other features not usually found in transmitter kits at this low price include: Ceramic-insulated final tank capacitor; pre-assembled switches; pre-wound parasitic chokes; ceramic coil forms; coax connector; crystal and VFO socket on front panel; power take-off jack for accessory equipment. Meter reads either plate or grid current of final. Takes crystal or VFO without circuit changes. Cabinet interior and chassis are copper-finished. Size, 8 $\frac{1}{2}$ x 10 $\frac{1}{2}$ x 8 $\frac{1}{4}$ ". With tubes and all parts for easy assembly. (Less crystal and key.) Shpg. wt., 19 lbs.

Model Y-255. 50-Watt Transmitter Kit. Net only. . . . \$38.95

knight-kit Self-Powered VFO Kit



Model Y-725

\$28⁵⁰

Only \$2.85 down

Complete with built-in power supply! Careful design and voltage regulation assure high stability. Excellent oscillator keying characteristics for fast break-in without clicks or chirps. Full TVI suppression. Has plenty of bandspread; separate calibrated scales for 80, 40, 20, 15, 11 and 10 meters; vernier drive mechanism. 2-chassis construction keeps heat from frequency determining circuits. Output cable plugs into crystal socket of transmitter. Output: 40v on 80, 20v on 40. With Spot-Off-Transmit switch for spot frequency tuning. Extra switch contacts for operating relays and other equipment. Attractive metal cabinet, 8 $\frac{3}{4}$ x 6 x 6". Ready for easy assembly. Shpg. wt., 8 lbs.

Model Y-725. VFO Kit. Net only. . . . \$28.50

knight-kit Amateur RF "Z" Bridge Kit



Model Y-253

\$5⁸⁵

Measures standing wave ratio (SWR) and impedance-of antenna systems; ideal for adjusting antenna systems for optimum results. Measures impedances from 20 to 400 ohms up to 100 mc; SWR to 150 mc. Any VOM may be used for null indicator. With coax input and output connectors. Meters both input and bridge voltage. Calibrated dial gives direct impedance reading; includes 1% precision resistor for precise calibration adjustment. With all parts and handy plasticized SWR chart (less meter). 2 $\frac{1}{2}$ x 3 x 4 $\frac{1}{2}$ ". Shpg. wt., 1 $\frac{1}{2}$ lbs.

Model Y-253. "Z" Bridge Kit. Net only. . . . \$5.85

ORDER BLANK

ALLIED RADIO

100 N. WESTERN AVE., CHICAGO 80, ILL.

ALLIED RADIO, Dept. RE; 100 N. Western Ave., Chicago 80, Ill.

Ship me the following KNIGHT-KITS:

Quantity	Description	Model No.	Price

\$..... enclosed. (For parcel post, include postage—express is shipped collect).

My Down Payment in the amount of \$..... is enclosed. Send Time Payment form.

Name.....

Address.....

City..... Zone..... State.....

ALL PRICES NET F. O. B. CHICAGO



FREE 1958
404-PAGE
ALLIED
CATALOG

See the 1958 ALLIED 404-Page Catalog for complete listings of

more than 50 KNIGHT-KITS, covering Hi-Fi, Hobby, Test Instrument and Amateur Kits. The 1958 ALLIED Catalog is your complete Buying Guide to the world's largest stocks of everything in Electronics.

Send FREE 404-Page 1958 ALLIED Catalog.

Transistorized FM Receiver

By JACK NAJORK

Simple changes permit the transistorized FM wireless microphone of July 1957 issue to be used as receiver.

READERS of RADIO & TV NEWS who have constructed the transistorized FM microphone (July 1957 issue) may be interested in the following modifications that can be made to convert this circuit into an FM receiver.

By grounding Base 2, increasing emitter bias, and adding a 100,000-ohm control as shown in the diagram below, the tetrode transistor becomes a superregenerative detector capable of receiving regular FM broadcasts and low-channel TV sound. Although the superregenerative detector recovers FM audio by means of slope detection, the audio quality can be surprisingly good for so simple a device.

As is true with most superregenerative circuits, certain component values are quite critical and may require experimentation for optimum results. This is especially true of the emitter bias resistor R_5 .

A high-impedance dynamic earphone can be connected in series with the collector to make a simple one-transistor FM receiver. When coupled to an external FM dipole, this circuit brought in the two local FM stations with good clarity. Current drain of the tetrode in this circuit is approximately .3 ma. at 6 volts.

While the original article designated the *G-E* type 3N30 tetrode which has a

rated frequency cut-off of 120 mc., the author used a less expensive version of this unit, the 3N29, which has a rated cut-off of 30 mc. Whether this individual unit is a freak or whether all 30 mc. units will operate at 100 mc. is not known, although one engineering opinion has it that the 30 mc. units will generally operate with reduced gain at frequencies above rated cut-off. Cost of the 3N29 is roughly half that of the 3N30.

After the bugs were worked out of the detector it was decided to add a transistorized audio amplifier to bring the audio output up to loudspeaker level. This circuit, shown below, uses two *G-E* 2N192 triode transistors in a class A direct-coupled circuit. Base bias resistor R_5 should be selected for maximum output consistent with low distortion. A standard size pentode-to-voice-coil output transformer was used in lieu of the more expensive miniaturized units generally specified. Those accustomed to audio in terms of watts will find it difficult to believe that this circuit, with an input of 4 ma. at 6 volts, will drive a speaker. Although the power output has not been measured, it is assumed to be approximately 10-15 milliwatts which drives a 12" speaker in a bass reflex enclosure to comfortable listening levels.

Schematic of FM "receiver" with a companion transistorized audio amplifier.

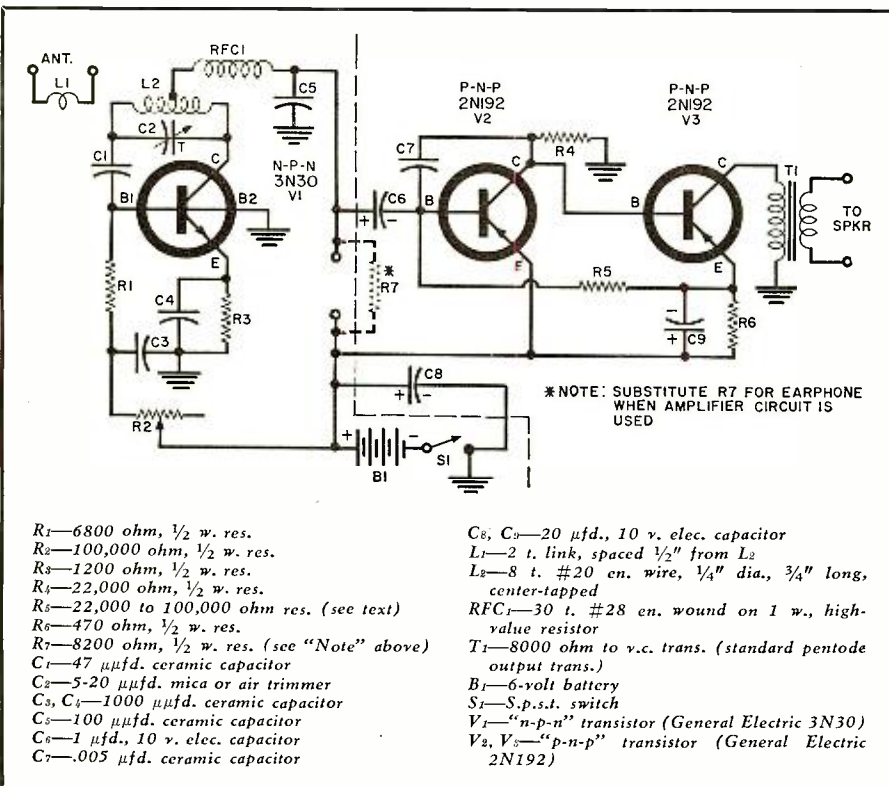

Tele-Vue

COMMUNICATIONS

TOWERS

FIT EVERY NEED

AMATEUR

HOME TV

INDUSTRIAL

Sturdy, dependable towers with exclusive design features. Easy to erect, easy to service . . . priced right.

Used by thousands—Hams, Signal Corps, Civil Defense, TV homes, communications and industry.

3 series—home TV telescopic, amateur telescopic, sectionals for industrial use.

ADJUSTABLE ROTOR POST

MOUNTING INSIDE TOP SECTION

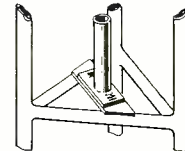

Mounting bearings to accommodate AR 22, C-D-R "HAM-M" and others, standard equipment on sectionals and models 30R, 40R and 50R hinged base or layover towers.

Enamel Finish or HOT DIPPED GALVANIZED AFTER ASSEMBLY. Superior design gives a clean uncluttered appearance.

Low shipping cost—will not exceed \$10 anywhere in U. S. on most telescopic models. Most areas \$5.00.

Export: Minthorne 15 Moore St., New York
Cable: Churchin, New York

TELE-VUE Towers, Inc.

701-707 49th St., So. St. Petersburg, Fla.

FREE BROCHURE RTN-1

Mail this coupon for full information

Amateur Distributor
 Dealer Industrial

Name _____

Address _____

City _____ State _____

Prices subject to change without notice

LAFAYETTE PROFESSIONAL TURNTABLE

with AUTHENTIC HYSTERESIS SYNCHRONOUS MOTOR

Value ~~129.50~~ Only **64.50**
SAVE OVER 50%

PROFESSIONAL TURNTABLE WITH HYSTERESIS-SYNCHRONOUS MOTOR

The Lafayette Model PK-225 is a true hysteresis-synchronous motor and is free from speed variations due to fluctuations in line voltage, load and temperature. It is the smoothest type known, completely free from "cogging" (the minute variations of speed which show up as wow and flutter)!

ONLY LAFAYETTE'S HYSTERESIS-SYNCHRONOUS MOTOR, in its price class, is made to extremely fine tolerances (on the order of .00001 inches)! Only Lafayette's motor has 16 cores; a high permeability rotor magnet, ball thrust bearings, oilite sleeve bearings plus felt oil reservoir, cooling fins as an integral part of the rotor and a hollow rotor core for maximum efficiency and minimum heat. Only Lafayette's motor can be oiled from above, without disassembly, through a unique oil feed system. Only Lafayette's motor has a self-aligning armature.

Here's THE turntable—the last word in professional high-fidelity performance! A fine precision instrument in every sense. Just look at some of these **OUTSTANDING FEATURES:- WOW AND FLUTTER:** Less than 0.2% • **TURN-TABLE:** Heavy, diecast aluminum. Lathe-turned for perfect balance and concentricity. 12" diameter—weighs approx. 4 lbs. and provides amazingly constant speed; the extra-heavy rim acts just like a flywheel to prevent speed variations • **TRUE-HYSTERESIS-SYNCHRONOUS MOTOR:** For smooth, low-noise, wow- and flutter-free operation • **RUMBLE AND NOISE:** 50db below average recorded level • **INTEGRATED SPEED CONTROL:** For all 3 speeds—78, 45 and 33½ rpm • **2 OVERSIZE, HEAVY DUTY IDLERS:** Precision-ground; provide positive constant-speed rim drive • **SINGLE BALL THRUST BEARING:** Turntable rides smoothly over ball bearing floating on thin film of oil • **FREE FLOATING, SHOCK-MOUNTED MOTOR** • **RUBBER CUSHION SHOCKMOUNTS** • **AUTOMATIC IDLER DISENGAGEMENT** • **CORK AND RUBBER MAT** • **STAINLESS STEEL PRECISION SPINDLE** • **POWER REQUIREMENTS:** For 105-130 volts, 60 cps AC; draws 16 V.A. • **ACCESSORIES SUPPLIED:** 45 RPM adapter, Strobe disc • **SIZE:** 2½" above and 4" below motor board; 14¾" deep x 12¼" wide • **SHIPPING WEIGHT:** 16 lbs.

LAFAYETTE MODEL PK-225 Net **64.50**
Deluxe Woodbase for PK-225 and 12" Tone Arm (Specify Finish). Shpg. wt., 13 lbs. Net **14.95**
Deluxe Woodbase for PK-225 and 16" Tone Arm (Specify Finish). Shpg. wt., 15 lbs. Net **15.95**

VISCIOUS DAMPED TRANSCRIPTION TONE ARMS

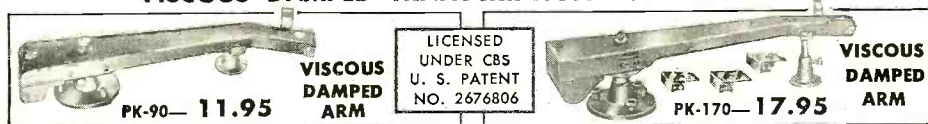

PK-90—**11.95**

VISCIOUS DAMPED ARM

LICENSED UNDER CBS U. S. PATENT NO. 2676806

PK-170—**17.95**

VISCIOUS DAMPED ARM

LAFAYETTE MODEL PK-225



SPECIAL MONEY-SAVER COMBINATION

PK-225 Turntable, PK-90 12" Tone Arm, New GE VRII Series Triple-Play Cartridge Model 4G-052 with Genuine GE Diamond and Sapphire Stylus. **SPECIAL!** Net **81.50**

3 WAY SYSTEM WITH 15" WOOFER . 8" MID-RANGE SPEAKER . . HORN TWEETER . . CROSSOVER NETWORK



SK-67

HW-7

SK-74

HK-3

LN-3

- 15-INCH WOOFER WITH 31.5 OZ. MAGNETIC (SK-67)
- 8-INCH MID-RANGE SPEAKER (SK-74)
- NEW HIGH FREQUENCY ACOUSTICAL LENS TWEETER (HW-7)
- 3-WAY CROSSOVER NETWORK (LN-3)

Lafayette presents this outstanding 3-way speaker system designed for the high fidelity enthusiast who desires performance formerly possible in multi-speaker systems costing many times this price. You won't believe your ears when you hear the superb reproduction throughout the entire audio spectrum. The SK-67 15" woofer provides phenomenal bass response, the SK-74 8" speaker delivers full bodied, mid-range frequencies, and the HW-7 high frequency acoustical lens tweeter faithfully reproduces the highest audible frequencies. Crossover points at 350 and 5000 cycles are provided by the LN-3 3-way inductance-capacitance network with continuously variable presence and brilliance controls that adjust tone balance to personal taste. Shpg. wt., 25 lbs.

SY-93. Complete System as listed above Net **55.50**

2 WAY SPEAKER SYSTEM 40-16,000 CYCLES

- 25 WATT WOOFER
- CROSSOVER NETWORK
- IMPORTED HI-FI TWEETER
- LEVEL BRILLIANCE CONTROL

This 2-way speaker system is another excellent buy for the moderate purse. It is basically the same as the SY-85 system described at the top of the page, but incorporates the deluxe SK-68 speaker with 21.5 oz. Alnico V magnet. This results in more efficient reproduction and extension of the lower register. Complete system includes the SK-68 12" 25 watt woofer, HK-3 cone type tweeter and LN-2 crossover network with level-brilliance control. Range of system 35-16,000 cycles. Shpg. wt., 18 lbs.

SY-87—Complete System Net **27.50**

PHANTOM VIEW SHOWS HOW SYSTEM MOUNTS IN CABINET

NEW! POWER MEGAPHONE ... Portable Sound Broadcaster

- Uses 8 Flashlight Cells
- Completely Self-Contained
- Weighs only 6½ lbs. with Batteries
- High Efficiency Horn Projects Sound 1000 Ft.
- Shoulder Strap for Portability and Ease of Use
- Microphone Detachable On 10-Foot Cord
- For Construction, Auctions, Carnivals, Fire & Police Use
- Also Ideal for Marine, Railroad, Civil Defense, Sporting Events

A power megaphone with many unusual features and many applications. Basically a highly efficient sound projector horn with a built-in microphone, capable of amplifying and projecting the voice with a range of 1000 feet. The microphone is a telephone-type element, easily replaceable, and may be detached and extended up to 10 feet from the horn. The reflex-type horn is extremely light-weight, rubber-rimmed, of strong, sturdy spun aluminum construction with 2¾" air column and is supplied with a strap for carrying or placing on the shoulder. A press-to-talk switch on the microphone provides for economy of power use—power is used only when actually talking. No warm-up time required—amplification is instantaneous. A patented non-linear current limiting device restricts current flow to safe levels for longest battery life. Uses 8 size "D" flashlight cells in series with an approximate life of about 10 hrs. of use. Battery housing serves as base for entire assembly. Battery compartment opens easily by means of 2 thumbscrews for battery replacement. Size 17" long overall; horn mouth is 12" diam. Shpg. wt., 8 lbs. less batteries.

PA-12—Power Megaphone, Less batteries.....Net **29.50**

BATTERIES FOR ABOVE—Burgess No. 2 or RCA VS036—8 RequiredNet each **.13**



Reg. Value ~~69.50~~

ONLY **29.50**

SHOULDER STRAP & DETACHABLE MIKE JUST AIM & TALK

Self-Contained—Only 6½ lbs. THROWS VOICE 1000 FT.



Lafayette Radio

165-08 Liberty Ave. JAMAICA 33, N. Y.

INCLUDE POSTAGE WITH ORDER

NEW YORK, N.Y. 100 6th Ave. REctor 2-8500

BOSTON, Mass. 110 Federal St. Hubbard 2-7850

BRONX, N.Y. 542 E. Fordham Rd. FOrdham 7-8813

NEWARK, N.J. 24 Central Ave. Market 2-1661

PLAINFIELD, N.J. 139 W. 2nd St. Plainfield 6-4748

FREE LAFAYETTE CATALOG

A Must For Every Hi-Fi Enthusiast

New! Years Ahead!



NEW 180 PAGE ELECTRONIC CATALOG FEATURING THE BEST BUYS IN THE BUSINESS
 The newest and largest assortment of Electronic, Radio and TV parts, Hi-Fi and Public Address Components and systems, Test Equipment, tubes, Transistor Kits and miniaturized components for transistor circuitry, Ham Equipment, Builders Kits, Tools, Books, Microscopes, Binoculars, Telescopes, Cameras, and Drafting Equipment.—**ALL AT LOWEST PRICES**—Catering to the economy minded dealer, serviceman, engineer, technician, experimenter and hobbyist. **CRAMMED FULL OF MONEY SAVING BUYS. SEND FOR YOUR FREE COPY TODAY.**

LAFAYETTE STEREO TUNER KIT

THE MOST FLEXIBLE TUNER EVER DESIGNED

- 11 Tubes + Tuning Eye + Selenium Rectifier • 12 Tuned Circuits
- Dual Double-Tuned Transformer Coupled Limiters
- Separately Tuned FM and AM Sections • Dual Cathode Follower Output
- Armstrong Circuit with FM/AFC and AFC Defeat
- Multiflex Output for New Stereo FM

More than a year of research, planning and engineering went into the making of the Lafayette Stereo Tuner. Its unique flexibility permits the reception of binaural broadcasting (simultaneous transmission on both FM and AM), the independent operation of both the FM and AM sections at the same time, and the ordinary reception of either FM or AM. The AM and FM sections are separately tuned, each with a separate 3-gang tuning condenser, separate flywheel tuning and separate volume control for proper balancing when used for binaural programs. Simplified accurate knife-edge tuning is provided by magic eye which operates independently on FM and AM. Automatic frequency control "locks in" FM signal permanently. Aside from its unique flexibility, this is, above all else, a quality high-fidelity tuner incorporating features found exclusively in the highest priced tuners.

FM specifications include grounded-grid triode low noise front end with triode mixer, double-tuned dual limiters with Foster-Seeley discriminator, less than 1% harmonic distortion, frequency response 20-20,000 cps $\pm 1/2$ db, full 200 kc bandwidth and sensitivity of 2 microvolts for 30 db quieting with full limiting at one microvolt. AM specifications include 3 stages of AVC, 10 kc whistle filter, built-in ferrite loop antenna, less than 1% harmonic distortion, sensitivity of 5 microvolts, 8 kc bandwidth and frequency response 20-5000 cps ± 3 db.

The 5 controls of the KT-500 are FM Volume, AM Volume, FM Tuning, AM Tuning and 5-position Function Selector Switch. Tastefully styled with gold-brass escutcheon having dark maroon background plus matching maroon knobs with gold inserts. The Lafayette Stereo Tuner was designed with the builder in mind. Two separate printed circuit boards make construction and wiring simple, even for such a complex unit. Complete kit includes all parts and metal cover, a step-by-step instruction manual, schematic and pictorial diagrams. Size is 13 3/4" W x 10 3/8" D x 4 1/2" H. Shpg. wt., 18 lbs.

The new Lafayette Model KT-500 Stereo FM-AM Tuner is a companion piece to the Models KT-300 Audio Control Center Kit and KT-400 70-watt Basic Amplifier Kit and the "Triumvirate" of these 3 units form the heart of a top quality stereo hi-fi system.

KT-500.....Net **74.50**

LAFAYETTE MASTER AUDIO CONTROL CENTER

with BINAURAL CHANNEL AND DUAL VOLUME CONTROL.

- Self-Powered • DC On All Filaments • 24 Positions of Equalization
- Tape Head Input, High Impedance • Dual Cathode Follower Output Stages

This is not only the finest hi-fi preamp characterized by unmatched features, but it has been ingeniously designed to keep pace with the conversion of your present hi-fi system to binaural (Stereophonic) sound. Incorporates an extra channel and dual volume control for binaural reproduction. Features include DC on all tube filaments, negative feedback in every stage, dual cathode follower output stages and latest printed circuit construction. Less than 0.09% IM distortion and less than 0.07 harmonic distortion at 1V. Hum and noise level better than 80 db below 3V. Uniformly flat frequency response over entire audible spectrum. 7 inputs for every type of phono, tuner or tape. Tasteful styling, brilliantly executed. Size 12 3/4" x 9 1/2" x 3 3/4". Shpg. wt., 10 1/2 lbs.

KT-300—Lafayette Master Audio Control Kit Complete with cage and detailed assembly instructions.Net **39.50**

LT-30—Same as above completely wired and tested with cage and instruction manual.

Net **59.50**

DELUXE 70 WATT BASIC AMPLIFIER

- Conservatively Rated At 70 Watts • Inverse Feedback • Variable Damping
- Metered Balance And Bias Adjust Controls • Available In Kit and Wired Form

Here's ultra-stability in a 70 watt basic power amplifier employing highest quality components conservatively rated to insure performance and long life. Features matched pair KT 88's and wire range linear Chicago output transformer, variable damping control, meter for bias and balance and gold finish chassis. Frequency response 10-100,000 cps ± 1 db. Hum and noise 90 db below full output. IM distortion less than 1 1/2% at 70 watts, less than 0.3% below 30 watts. Harmonic distortion less than 2% at 70 watts from 20 to 20,000 cps ± 1 db. Output Impedance 4, 8 and 16 ohms. Handsome decorative cage perforated for proper ventilation. Size 14 1/2" x 10" x 7 3/8" including cage and knobs. Shpg. wt., 40 lbs.

KT-400—Lafayette 70 watt Deluxe Basic Amplifier Kit complete with cage and detailed assembly instructions.Net **69.50**

LA-70—Same as above completely wired and tested with cage and instruction manual.

Net **94.50**



KT-500 IN KIT FORM **74.50**

ONLY 7.45 DOWN 7.00 MONTHLY



KT-300 IN KIT FORM **39.50**

KT-400 IN KIT FORM **69.50**

ONLY 6.95 DOWN 7.00 MONTHLY

NEW! LAFAYETTE SCOOP!

DUAL WIDE-ANGLE TWEETER

Modernize Your Hi-Fi System

Modernize your high fidelity listening by adding this wide-angle dual-tweeter to extend treble range in a 2-way or 3-way speaker system. Mounts directly on any 12" speaker and converts it to a coaxial type. Response 2500 to 16,000 cps. Recommended crossover 2500 to 4000 cps. Heavy magnets for high efficiency. Dispersion angle approx. 125° horizontally. Impedance 16 ohms (2-8 ohm units in series). Will handle up to 20 watts program in 2 or 3-way systems. Incorporates specially designed chrome-plated steel bracket of rigid construction to prevent resonances. Measures 12" L x 2" D x 2 1/8" H overall. Shpg. wt. 2 lbs. SK-100 Dual Tweeter Net **5.95**



Only **5.95**

Lafayette Radio

DEPT RE

P. O. BOX 511 JAMAICA 31, N. Y.

Send FREE LAFAYETTE Catalog 305

Name **CUT OUT AND MAIL TODAY**

Address

City..... Zone..... State.....

**60 NEW PROJECTS FOR
"DO-IT-YOURSELFERS"**

in the NEW EDITION of the
**ELECTRONIC
EXPERIMENTER'S
HANDBOOK**



IMPORTANT NEWS: The new 1958 Edition of the *Electronic Experimenter's Handbook* is now on sale. If you like to build useful, profitable electronic devices, pick up a copy of the new *Handbook* now. Last year's edition sold so fast many hobbyists, experimenters, and students couldn't buy a copy . . . and this year's *Electronic Experimenter's Handbook* contains even *more projects, more pictures, more guidance!* Each device has been pre-tested and operated by readers of *Popular Electronics*. You'll find step-by-step instructions, hundreds of photos, drawings and unique "pictorial diagrams."

60 Devices . . . Nearly 200 pages . . . a Practical "File" of Electronics Ideas and Information

FOR YOUR HI-FI. Presence control. Hi-fi crossover. Filter. Electrostatic speaker system. Mixer equalizer. Spare amplifier. \$5 coax oval-flex speaker enclosure. Junior hi-fi. Hard-ware store crossover.

RECEIVERS. Shirt pocket transistor superhet. Vokar receiver. Superegen unit. Miniature VHF ear. Junkbox BC receiver. Etched circuit two-tuber.

FOR YOUR HOME. Invisible light door opener. Picnic power amp. DC supply for AC/DC motors. Installing back seat speaker. Light-operated relay. Transistorized intercom. Radio intercom.

FOR YOUR DARKROOM. Audio photometer. Transistor slave flash unit. Photographer's electric pencil. Light distributor. Darkroom timer. Enlarger exposure meter.

FOR YOUR HAM SHACK. Simple shortwave receiver. VHF explorer's receiver. 70-watt transmitter. Double your Heathkit AT-1 output. Code practice set. Antenna tuner. Transistor 10-meter receiver.

FOR YOUR WORKSHOP. Economy signal generator. Simple oscilloscope calibrator. Rejuvenator for dry cells. \$14 signal tracer. Transistor checker. Capacitor meter. Low-cost multi-tester. Transistorized signal tracer. Buzzer-type power supply.

FOR THE KIDS. IQ tester. Electronic worm digger. Model spaceship. Game computer. Transistorized phonograph amplifier. Coin operated oscillator.

SPECIAL PROJECTS. Solar battery experiments. Electronic anemometer. Varistrobe. Detectorscope. Simplified etched circuits. Car rattle locator. Simple burning tool.

ON SALE NOW—Only \$1

Buy Your Copy Today at Your Newsstand or Radio Parts Store

ZIFF-DAVIS PUBLISHING CO., 64 East Lake St., Chicago 1, Ill.

The Zero Clipper
(Continued from page 41)

equipment. This construction is recommended, if possible, because it gives a firm, solid support with minimum capacity between leads and components.

In operation, first set the potentiometer for no clipping (maximum noise) and then turn the control for the most intelligible signal. One unexpected dividend was operation with signals which were completely intelligible, but with a high background noise. The zero clipper circuit made these signals more pleasant by cutting down the background noise at the expense of a small amount of audio distortion. Other applications which suggest themselves are: cutting down background hiss and scratch with old phonograph records and cutting down the unpleasant high level of background noise in a phone transmitter which uses peak clipping to increase apparent modulation percentage. —30—

**CAUTION FOR
SQUARE-WAVE TESTING
TRANSISTOR AMPLIFIERS**

By RUFUS P. TURNER

RECENTLY, a colleague of the author lost three transistors in a row by burn-out, for no apparent reason, while attempting a square-wave test of a transistorized audio amplifier. A troubleshooting analysis of the circuit revealed that the transistors were being wrecked by a high-voltage pulse generated by the steep fall of the wave across the primary of the coupling transformer in the collector circuit.

The situation is very much the same as in the small, flyback-type power supplies in Geiger counters in which a choke coil is connected in the plate circuit of a tube. When the grid is pulsed with a saw-tooth or similar steep-wave signal, the rapid fall of current generates 1 or more kilovolts across the choke. The difference is that the insulation of the tube is good enough to withstand this voltage, but the transistor cannot take it because of its low peak inverse voltage rating.

Caution therefore is needed when square-wave testing a transistorized amplifier having transformer or choke coil coupling. Every effort should be made to ascertain that flyback action will not produce a voltage in excess of the peak inverse rating of the transistor. Perhaps, it would be more sagacious to dispense with the square-wave test altogether and to employ instead harmonic distortion, intermodulation, and frequency-response measurements until such time as transistor peak inverse ratings are greatly improved.

This situation caused us to wonder if some of the mysterious burn-outs of transistors might not have been attributable to the same cause. A quick poll of our associates revealed that they had indeed lost transistors with sudden swiftness in pulse amplifiers, blocking oscillators, and similar circuits in which the "wrecking voltage" was developed by the steep waveform across a collector-circuit inductor. —30—

VIDEO ELECTRIC COMPANY says: DOWN WITH RISING COSTS OF ELECTRON TUBES OVER ONE MILLION USED TUBES TO SELECT FROM at only

Each and every tube is tested by our supplier under actual operating conditions in Radio, FM, Hi-Fi, Industrial Equipment and Television Chassis or Intricate Testing Equipment for Mutual Conductance and Life Test.

Below is a Partial List of Over Three Hundred Popular Types!
Write for Free Complete List and Order Blank!

0A2	5AX4GT	6BC5	6L7	717	19
0B2	5AZ4	6BC7	6N7	7N7	19AU4GT
0Z4	5BR8	6BC8	6Q7	7X7/XXFM	19BG6G
1A5GT	5BQ7	6BD6	6S4	7Y4	19J6
1A7GT	5C8B	6BE6	6S8GT	7Z4	19TB
1B3GT	5D4G	6BF5	6SA7	12A8	24A
1C5GT	5E8	6BF6	6SB7Y	12AB5	25AV5
1H4G	5U4GB	6BG6G	6SC7	12AQ5	25AX4
1H5GT	5U8	6BH6	6SF7	12AT6	25BQ6
1J6	5V4G	6BK5	6SH7	12AT7	25L6GT
1L4	5V6GT	6BK7	6S17	12AU6	25W4GT
1N5GT	5Y3GT	6BL7GT	6SK7	12AU7	25Z5
1Q5GT	6A7	6BN6	6SL7GT	12AV5	25Z6
1R5	6A8	6BQ6GT	6SN7GT	12AV6	26
1S5	6AB7	6BQ7	6SQ7	12AV7	35A5
1T4	6AC7	6B58	6SR7	12AX4GT	35B5
1T5GT	6AG5	6B7GT	6S57	12AX7	35C5
1U4	6AC7	6B85	6T4	12AZ7	35L6GT
1U5	6AD7	6B86	6T8	12BA6	35W4
1V2	6AE5	6B87GT	6U4GT	12BA7	35Z4GT
1X2	6AF4	6B96	6U5	12BD6	35Z5GT
1X4	6AG7	6BZ6	6U8	12BE6	36
2A3	6AG5	6BZ7	6V3	12BF6	37
2A7	6AH4GT	6C4	6V6	12BK5	39/44
2AF4	6AH6	6C5	6W4GT	12BK6	42
3AL5	6AK5	6C6	6W6GT	12BR7	43
3AV6	6AL7	6CB5	6X4	12BV7	45
3BC5	6AM8	6CB6	6X5	12CA5	50A5
3BE6	6AN5	6CD6G	6X8	12D06	50B5
3BN6	6AQ5	6CF6	6Y6G	12F5	50C5
3BY6	6AT6	6CG7	7A4/XXL	12K7	50C6
3BZ6	6A78	6CL6	7A5	12L6	50L6GT
3CB6	6AU4GT	6CM6	7A6	12M7	50X6
3CF6	6AU5GT	6CM7	7A7	12N7	50Y6
3C56	6AU6	6CN7	7A8	12P7	56
3DT6	6AV5GT	6CU5	7B4	12Q7	57
3LF4	6AV6	6DE6	7B5	12S7	58
3Q4	6AW8	6DT6	7B6	12S7GT	71A
3Q5GT	6AX4GT	6E5	7B7	12SN7GT	75
3S4	6AU8	6F6	7B8	12T7	76
3V4	6AV8	6F8	7C4	12U7	77
4BC8	6AW8	6G1	7C5	12V6GT	78
4BQ7A	6AX4GT	6G2	7C6	12W6GT	80
4BZ7	6B4G	6G3	7C7	12X4	84/6Z4
5AM8	6B4G	6G4	7E5	12Y6GT	117L7GT
5AN8	6BA6	6G5	7E6	12Z3	117N7GT
5AQ5	6BA7	6G6	7E7	14A7/12B7	117P7GT
5AS8		6G7	7F7	14B6	117Z3
5AT8		6K6GT	7F8	14Q7	117Z6
5AU4		6K7	7G7/1232		
5AV8		6K8	7H7		
5AW4		6L6			



GUARANTEE: We guarantee to replace FREE for one (1) year any tube purchased from us which fails to function efficiently under actual operating conditions. Refunds will be made promptly for any defective merchandise.

WE HAVE OVER 1000 USED TV SETS

At All Times In Our Huge Warehouse Buy one or more of these WORKING TVs to sell or use as your own second set! All sets in GOOD WORKING condition! Your Choice—Console or Table Model

10" ...	\$23.00	17" ...	\$46.00
12" ...	\$28.00	19" ...	\$58.00
14" ...	\$33.00	20" ...	\$64.00
16" ...	\$40.00	21" ...	\$72.00
24" ...	\$99.00		

When ordering TVs, state whether table model or console is desired. Also, preference on make of set. All TVs sent railway express, F.O.B. Newark. On any quantity, WIRE or CALL today!

SEND for our FREE complete TUBE & PARTS LIST and order blank.

FREE
Bonus Antenna Given with Any TV Set Order!!

FREE
RCA "Cheater" Cord Given with Any Tube Order of \$7.00 or More!!

VIDEO

FREE POSTAGE

In U.S.A. and Territories on orders over \$5.00. 25¢ handling charge on orders under \$5.00. 25% deposit required on C.O.D.'s. Please send approximate postage or freight on Canadian and foreign orders. Subject to prior sale.

Phone Humboldt 4-9848

ELECTRIC COMPANY
79 CLINTON PL. NEWARK, N. J.

Get Your First Class Commercial F.C.C. LICENSE in 12 Weeks!

F.C.C. License—the Key to Better Jobs

An FCC commercial (not amateur) license is your ticket to higher pay and more interesting employment. This license is Federal Government evidence of your qualifications in electronics. Employers are eager to hire licensed technicians.

Learn by Mail or in Resident Classes

Grantham School of Electronics specializes in preparing students to pass F.C.C. examinations. Correspondence training is conducted from Washington and Hollywood; resident DAY and EVENING classes are held in both cities. Either way, we train you quickly and well—NO previous training required. A beginner may qualify for his first class F.C.C. license in as little as 12 weeks.

Here's Proof! A few of our recent graduates, the class of license they got, and how long it took them:

Name	License	Weeks
Edward Dahl, 7800 Old Chester Rd., Bethesda, Md.	1st	11
Griffin Kane, 3125 Wabash Ave., Los Angeles, Calif.	2nd	9
Beamon Meares, 1536-17th St., NW, Washington, D.C.	1st	11
Larry Pacifico, 65 Main St., Roseto, Pa.	1st	12
Tooru Iwahashi, Honohina, Hakalua, Hawaii	2nd	8
Basil D'Imperio, 2223 H St., NW, Washington, D.C.	1st	12
John Ward, 407 E. Cowden Ave., Midland, Texas	1st	10
Herbert Halbig, 315 Park St., Tupper Lake, N. Y.	1st	11
Vregh Godoshian, 312 E. Wilson St., Pontiac, Mich.	1st	11
Antone Mello, 68 Union St., Nantucket, Mass.	1st	10
James Farish, 926 Cardone Ave., Reno, Nev.	1st	12
Charles Page, General Delivery, Yuma, Ariz.	1st	16
E. H. Siddall, 13351 Magnolia Ave., Van Nuys, Calif.	2nd	8
James Craig, 4004 - 19th St., S., Arlington, Va.	1st	11

Grantham's Communications Electronics Course

offers you complete preparation for F.C.C. examinations required for a first class F.C.C. license. Even though it is planned primarily as preparation for F.C.C. examinations, it is **not** a "cram course" but prepares you by TEACHING you electronics.

OUR GUARANTEE If you should fail the FCC exam after finishing our course, we guarantee to give you additional training at NO ADDITIONAL COST. Read details in our free booklet.

FCC-TYPE EXAMS FCC-type tests are used throughout the Grantham course. Constant practice with these FCC-type tests helps you prepare for the actual FCC examination.

TWO COMPLETE SCHOOLS: To better serve our many students throughout the entire country, Grantham School of Electronics maintains two complete schools—one in Hollywood, California and one in Washington, D. C. Both schools offer the same rapid courses in FCC license preparation, either home study or resident classes.

MAIL TO SCHOOL NEAREST YOU

(mail in envelope or paste on postal card)

Grantham Schools, Desk 86-E

1503 N. Western Ave. OR 821 - 19th Street N.W.
Hollywood 27, Calif. Washington 6, D. C.

Please send me your free booklet telling how I can get my commercial F.C.C. license quickly. I understand there is no obligation and no salesman will call.

Name

Address

City State

I am interested in: Home Study. Resident Classes

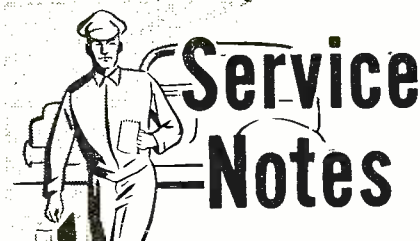

BRIGHTNESS RANGE, PHILCO

In some 1952 models, the range of the brightness control is not adequate to permit cutting off of beam current entirely in the minimum-brightness position. This is considered objectionable by some users. In order to bring the range down enough to permit extinguishing the picture completely at minimum settings, resistor R_{318} , in the cathode circuit of the picture tube, may be reduced in value from 82,000 ohms to 68,000 ohms.

When this exchange is made, a slight decrease in light output at maximum brightness also occurs. To recover this loss R_{314} , also in the cathode of the picture tube, is reduced from 120,000 ohms to 100,000 ohms.

ADMIRAL IMPROVEMENTS

Suggested changes noted here apply to the 17B1, 17C1, 17K1, and 17L1 chassis, as well as to their combination v.h.f.-u.h.f. counterparts (17AB1, 17AC1, etc.).

While a.g.c. action is inherently good in these receivers, which use a gated-a.g.c. circuit, the full capabilities of this circuit may not be realized in some earlier models. If improvement is desired, check the value of C_{128} , connected between the plate (pin 3) of the a.g.c. stage (V_{401}) and the flyback transformer. See Fig. 1. If this is a 300- μ fd. unit, replace it with another whose value is .001- μ fd., 1600 volts. This will increase the amplitude of the keying pulse fed to the stage.

In some of the v.h.f.-u.h.f. sets, there may be a tendency for strong signals to produce overload. If this occurs, check the value of R_{401} , also in the plate circuit of the a.g.c. amplifier and going to the primary circuit of T_{303} , the third i.f. transformer, through resistor R_{315} . If R_{401} is 10 megohms, replace it with another whose value is 15 megohms.

If there is a tendency for sound to distort due to frequency drift in the sound detector—specifically, drift in

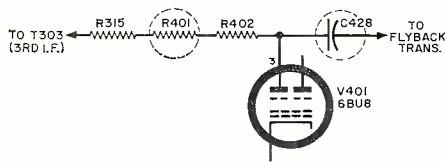

Fig. 1.

the quadrature tank circuit connected to pin 7 of V_{201} , the 6DT6—a change in the value of R_{207} , which shunts this tank, should remedy the condition. The 220,000-ohm unit in this position should be replaced with a 100,000-ohm resistor.

Attention Photographers THE SECRET OF "BUYING SMART" costs you only a Dollar!

You've noticed how some people seem to have a knack for buying photo equipment. Before they go into a store they know the kind of equipment they want, the manufacturer, model, features, and the price. They've compared beforehand . . . and saved themselves time, effort and money.

What's the secret? For many it's the *Photography Directory & Buying Guide* . . . a handsome catalog of all photographic equipment on the market compiled by the editors of *Popular Photography*. It tells you everything you want to know about more than 5,000 products, from cameras and lenses to film and filters—for black and white or color, for movie or still photography. The cost? Only \$1.00.



**1958 Edition
Has These
Extra Features**

Besides listing over 5,000 new photo products (and illustrating more than 1,000 of them), the 1958 *Photography Directory & Buying Guide* includes helpful, simplified CAMERA COMPARISON CHARTS. These charts compare the prices, shutter ranges, lens speeds and other features of over 300 press, 35mm and reflex cameras. In addition, a special 16-page section on FOTO FACTS gives data and figures on filters, films, lenses, exposure and conversion scales. An exclusive bonus, PHOTO SHORTCUTS points out ways to save money when you shoot, light, print and process. A section on PORTRAIT LIGHTING SETUPS lists tested diagrams for lighting a model. As additional features, the 1958 *Photography Directory* suggests sample MODEL RELEASE FORMS and a roundup of the LATEST BOOKS ON PHOTOGRAPHY.

You'll be able to buy the new *Photography Directory* soon. This 1958 Edition, priced at only \$1.00, will sell fast! So to insure yourself of a copy, reserve one at your newsstand or photo dealer's now.

ZIFF-DAVIS PUBLISHING CO.
64 E. Lake Street
Chicago 1, Illinois

RADIO & TV NEWS

All changes suggested here were incorporated at various points during the production of these *Admiral* receivers.

PIX QUALITY IN ARVIN TV

Changes in the video-amplifier circuit of "D" series receivers (chassis 379 and 382) can be made to improve picture quality, especially under weak-signal conditions. These are made in the input and output circuits of V_8 , a 6AQ5, the second video amplifier. The original circuit, Fig. 2A, is revised to correspond to the circuit shown in Fig. 2B as follows: Peaking coil L_{209}

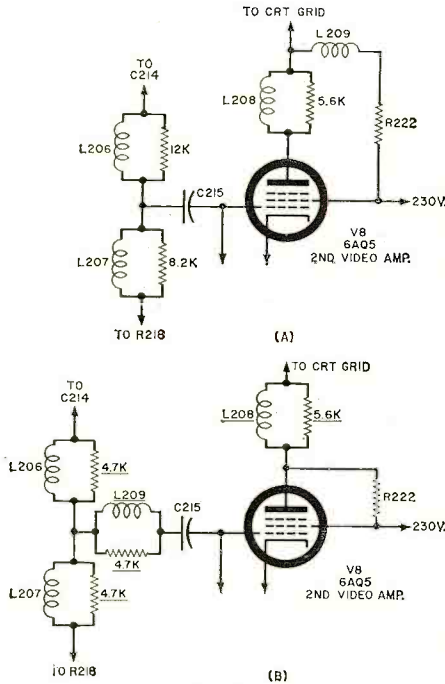

Fig. 2.

is moved from the plate circuit of the stage and connected in series with C_{215} in the grid circuit, as shown. R_{222} is then reconnected directly between the screen grid and the plate of the video amplifier. A 4700-ohm resistor is shunted across L_{209} and the shunt resistors across L_{206} and L_{207} are each changed to 4700 ohms.

POOR FOCUS AND WASH-OUT

Sometimes receivers using low-voltage, electrostatically focused picture tubes, like the 21MP4, may show poor focus and wash-out of the picture in the center area of the picture-tube screen. This may be noted, for example, in *Montgomery Ward* models 25WG-3075A & B, -77A & B, and -79A. This condition is generally the result of incorrect positioning of the ion trap.

Visual inspection of the 21MP4 picture tube will show that the electron gun is closest to the glass neck on one side. The ion trap magnet should be positioned on this side. When the receiver is viewed from the rear, then, this will mean that the ion trap should be on the left in nearly all cases. It may be necessary to reverse the ion trap to adjust it for maximum brilliance.

-30-

Just 2 settings on the NEW

Model FC-2

FAST-CHECK TUBE TESTER

tests over 600 tube types completely, accurately... AND IN SECONDS!

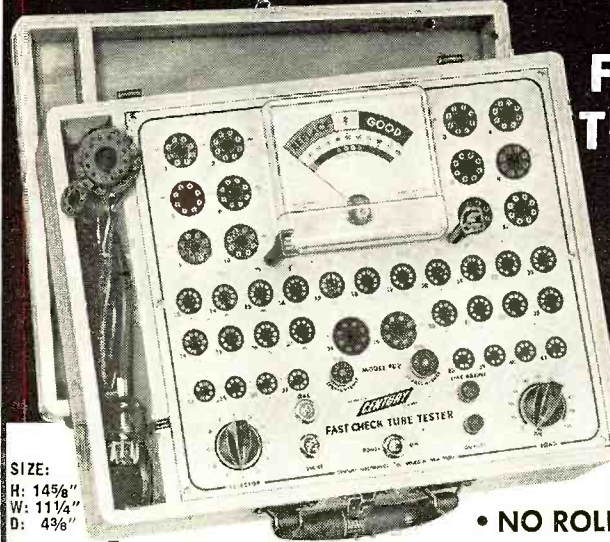

SIZE:
H: 14 5/8"
W: 11 1/4"
D: 4 3/8"

NEW Special compartment to accommodate line cord and CRT Test Adapter cable

CANNOT BECOME OBSOLETE

Engineered to accommodate all future tube types... new tube listings furnished periodically.

TRY THE FC-2 BEFORE YOU BUY IT!

Shipped on approval for FREE 10 day trial... No obligation to buy

EASY TO BUY IF YOU'RE SATISFIED!

Pay in small monthly payments at net cash prices... no financing charges

MODEL FC-2—housed in rugged oak carrying case complete with CRT adapter, tube listings... only **\$69.50** Net

GUARANTEED FOR 1 FULL YEAR

This extremely low price is made possible only because YOU ARE BUYING DIRECT FROM THE MANUFACTURER

The FAST-CHECK enables you to save valuable time and eliminate unprofitable call backs. You earn extra money and win confidence by showing your customer the actual condition and life expectancy of the tube on the large meter scale of the FC-2. The extra tubes you will sell each day will pay for the FAST-CHECK in a very short time.

- NO MULTIPLE SWITCHING
- NO ROLL CHART CHECKING

WIDE RANGE OF OPERATION

- Checks quality of over 600 tube types... more than 99% of all TV and radio tubes, including the newest series-string TV tubes, auto 12 plate-volt tubes, OZ4s, magic eye tubes and gas regulators.
- Checks inter-element shorts and leakage.
- Checks for gas content.
- Checks for life expectancy.

IMPORTANT FEATURES

- ✓ Checks each section of multi-section tubes and even if only one section is defective the tube will read "Bad"
- ✓ 41 long lasting phosphor-bronze tube sockets accommodate all present and future tube types—cannot become obsolete
- ✓ Less than 10 seconds required to test any tube
- ✓ Large D'Arsonval type meter: is extremely sensitive yet rugged—is fully protected against accidental burn-out
- ✓ Line isolated
- ✓ 7-pin and 9-pin straighteners conveniently mounted on panel
- ✓ Quick reference tube chart lists over 600 tube types
- ✓ Line voltage compensation

NEW A specially designed PICTURE TUBE ADAPTER cable is now part of the FC-2... making it a highly efficient CRT Tester-Rejuvenator. This feature eliminates the need of carrying extra instruments and makes the FC-2 truly an all-around tube tester. The adapter enables you to check all picture tubes (including the new short-neck 110 degree picture tubes) for cathode emission, shorts and life expectancy... also to rejuvenate and restore cathode emission of weak picture tubes.

"You've really made tube testing a snap"... "I've almost got the cost of the Fast-Check paid off with the extra money I've made, and it's only 2 weeks since I received it"... "It's easier to use than you said"... "I wouldn't ever want to be without it"... "I use it in the shop and take it along on every call!"

WHAT SERVICEMEN* are SAYING ABOUT THE FC-2

*Names on request

MAIL COUPON NOW—NO MONEY REQUIRED WITH ORDER

CENTURY ELECTRONICS CO., INC. 111 Roosevelt Avenue Dept. 205, Mineola, N. Y.

Please rush the new Model FC-2 FAST-CHECK TUBE TESTER for a 10 day trial period. If I am not completely satisfied I will return the instrument within 10 days without further obligation. If fully satisfied I agree to pay the down payment within 10 days and the monthly installments as shown. No financing charges are to be added. Should I fail to make payment when due, the unpaid balance shall become due and payable at once.

- BUDGET TERMS:** Pay \$14.50 within 10 days after receipt of instrument. Balance \$11.00 monthly for 5 months, plus shipping charges.
- PREPAID TERMS:** Enclose \$69.50 with coupon as payment in full and Century will pay all shipping costs. 10 day money-back guarantee.

Name.....
Address.....
City..... State.....

ABSOLUTELY NO RISK ON YOUR PART

FILAMENT TRANSFORMERS

Primary 115V. or 230V.-60 Cy. Sec. 6.3 V. @ 20 Amps. Size: H-4 1/2" x W-4" x D-3 1/2". Each **\$3.50**

Primary 110 volt 60 cycle. Secondary 2 1/2 V. 10 amps 10,000 V. Insulation. Suitable for pair of 866 tubes. Each **\$3.95**

PLATE TRANSFORMERS

Fully Shielded. Primary 110V. 60 cy. Secondary 1450-0-1450 @ 500 Ma. Each **\$14.95**

CHOKE—FULLY CASED

10 HENRY 80 Mill (unshielded)	90c
6 HENRY 150 Mill	\$1.50
8 HENRY @ 200 Ma	1.95
4 HENRY 300 Mill	2.95
8 HENRY 500 Mill	5.95
20 HENRY 800 Mill	9.95

OIL CONDENSER SPECIALS BRAND NEW

2 MFD 600 VDC .50	4 MFD 2000 VDC 3.50
4 MFD 600 VDC .75	6 MFD 2500 VDC 2.50
6 MFD 600 VDC .85	2 MFD 3000 VDC 2.50
8 MFD 600 VDC .95	4 MFD 2500 VDC 4.95
10 MFD 600 VDC 1.19	1 MFD 3000 VDC 4.95
12 MFD 600 VDC 1.50	4 MFD 3000 VDC 5.95
1 MFD 1000 VDC .60	1 MFD 7500 VDC 6.95
2 MFD 1000 VDC .85	5 MFD 7500 VDC 2.95
4 MFD 1000 VDC 1.35	2 MFD 10,000 VDC 39.95
8 MFD 1000 VDC 1.95	1 MFD 15,000 VDC 34.50
10 MFD 1000 VDC 2.95	1 MFD 25,000 VDC 69.50
1 MFD 1200 VDC .45	10 MFD 330 AC 1.95
1 MFD 1500 VDC .75	15 MFD 440 AC 2.50
2 MFD 1500 VDC 1.19	8 MFD 660 AC 2.35
8 MFD 1500 VDC 2.95	1 MFD 2000 VDC .85
24 MFD 1500 VDC 6.95	2 MFD 2000 VDC 1.50
1 MFD 2000 VDC .85	
2 MFD 2000 VDC 1.50	

REDMOND BLOWER

110V. 60 cyc. .3 Amp. 1600 Rpm. 3 3/4" Blower wheel—Outlet 2" Diameter. Suitable for cooling Transm. tubes, etc. **\$7.95**
2 for \$15.00

AC-DC PROBE

2 METERS IN PROBE
1 meter measures Voltage 55, 110, 220, 440. Second meter indicates whether AC or DC, and if DC, polarity at tip of probe. **\$5.50**
PRICE

SIGMA 5F RELAY

16,000 ohm in dual 8,000 ohm coils. (Can be paralleled) SPDT adjustable silver contacts. Adjustable armature tension. Operates on 500 microamperes or less. Ultimate in a sensitive relay. Ideal for precision control work **\$3.95**
Write for quantity prices.

RELAYS

Sealed Claire SPST. Norm. closed 3000 ohm coil 4 ma.	95c
Claire Telephone Type 11,300 ohm coil DPDT cont. 10 amp 125V. Sens. 4MA. ea.	\$3.95
Hermetically Sealed Relay Coil 110V AC 60 cy SPDT Contacts 5 Amps.	\$1.85
110 V. AC DPDT	\$1.75
Contacts 10 Amps.	\$1.95
110 V. AC TPDT	\$1.95
Contacts 5 Amps.	\$1.95
6 Volt DC	99c
DPDT H.S.	\$1.35
12 Volt DPDT DC Relay	\$1.35
Each	\$1.05
12 Volt DPST Advance Relay	\$1.05
Each	\$1.05
Granter Time Delay Relay, 220V 60 cy. 45 sec. adj. 2 pole DT.	\$6.95
G.E. Plug in Relay 5 prong 10,000 ohm coil 1 mil. SPDT.	\$2.50
Telephone type relay 12 V. DC @ 10 ma. triple pole single throw. Normally open. G.E. Relay control, contains 8000 ohm relay, sensitivity 2 mils. 10 for \$9.25. ea.	\$1.10

PANEL METERS

G.E., WESTINGHOUSE, W.E., SIMPSON, etc.

2" METERS	
0-200 Ma DC	2.95
0-500 Mill DC	2.95
1-0-1 Amps DC	2.95
0-10 Amps DC	2.95
0-25 Amps DC	2.95
18-36 Volts DC	1.99
0-50 Volts DC	2.95
0-150 V. AC	3.49
0-4 Amps RF	2.95
3" METERS	
20-0-20 Micro	8.95
0-50 Micro	6.95
150-0-1500	6.95
0-100 Micro	5.95
(Scale 0-3)	5.95
0-5 Mill DC	3.95

MISCELLANEOUS SPECIALS

N.E. 51 NEON LAMPS, Box of 10 **\$1.00**
Write for quantity prices
50 OHM 6 watt (Non-Inductive) **35c**

All merchandise sold on a 10 day money back guarantee basis

Min. Order \$3.00—25% with Order—F.O.B. New York

PEAK

ELECTRONICS COMPANY
66 W. Broadway, New York 7, N. Y., WO-2-5439

New TV Front Ends

(Continued from page 68)

plate and the mixer grid circuit is provided by a capacitor and "gimmick" for the low channels; for the high band, the individual coils at the end of each strip of 2 or 3 channel sections couple between each other.

The advantages of the disc-type tuner include its ease of disassembly, repair, and servicing, as well as the rugged construction made possible by the self-wiping kidney springs and the solid molded discs. In some early models, the detent spring and its roller rode directly on the scalloped edge of the smaller disc, but even the strong plastic used could not bear the constant pressure; in later models a steel plate is riveted to the disc and the steel edge bears against the detent roller.

As far as alignment is concerned, the complexity of the disc tuner is about half way between that of a turret tuner and a wafer-switch tuner. Only a few channels must be adjusted in order to align one particular one. If a coil has to be repaired, it is easy to get at since the entire assembly can be removed as simply as a turret could be slipped out of its bearings. This tuner is also somewhat shorter and takes less space than the turret and most switch tuners. This is an important feature in the already cramped space of today's compact TV sets.

Another version of a disc-type tuner is the *Standard Coil "Fireball,"* which is still more compact and simpler than the one just described. In the "Fireball" tuner, as shown in Fig. 12, the two tubes are side by side in front and a single rotating disc contains all tuned switching circuits. Principally available in the Neutrode circuit, described in more detail in the next paragraph, this tuner combines very good noise and gain figures with a very simple mechanical arrangement.

By unsnapping the cover, all components are accessible and servicing is quite simple. At the same time individual stage adjustments are possible for the input, plate, and mixer-grid coils; and oscillator adjustment for each channel is done from the front in the usual manner. This tuner has 13 positions, allowing for the addition of u.h.f. without major change. For u.h.f. reception, the oscillator "B+" is disabled and separate coils are added outside the main disc, making the tuner a 41-mc. two-stage amplifier.

Turret Tuners

No discussion of tuners would be complete without covering the latest version of the enduring *Standard Coil* turret tuner. Readers will be familiar with the appearance of this unit, but the new circuits used merit some explanation.

Fig. 13 is the circuit diagram of the

latest Neutrode turret tuner, as used in the *Packard-Bell* chassis 98D3. The major features are the neutralized triode r.f. amplifier and the d.c. type remote-control fine tuning. A 6BN4 high-frequency triode is used as r.f. amplifier, and the capacitor network going from the plate circuit to the grid circuit serves to neutralize the otherwise regenerative condition of a triode amplifier at high frequencies. Note that the 6BN4 has double socket pins for grid and cathode to reduce internal lead inductances. Otherwise the circuit is extremely simple and straightforward. Contained on a single turret channel strip or segment are the r.f. amplifier grid coil, the plate circuit, and the mixer grid network, as well as the oscillator coil. Coupling between the r.f. amplifier and the mixer is inductive, and optimized for each channel by the configuration of the coils on the segment.

The oscillator circuit uses a single coil between grid and plate and this coil is, as usual, adjusted by a self-contained slug accessible from the front of the tuner. In place of the concentric shaft and fine tuning mechanism is a choke coil and a diode, mounted close to the oscillator tube socket.

The electronic fine-tuning system actually operates on the oscillator signal itself, since the 1N87 crystal rectifies a portion of the oscillator signal. The 1000- μ fd. bypass capacitor filters out the r.f. component and the remote fine-tuning control, not shown, is a 50,000-ohm potentiometer going to ground. As the potentiometer resistance is varied, the impedance represented by the crystal is varied. This, in turn, changes the oscillator frequency. The choke coil going to ground from the crystal provides a d.c. return path and serves as high impedance for the r.f. signal. Frequency variations obtained by this method range from .5 mc. at the low TV channels to 1.1 mc. at the high band.

If fine tuning does not properly change the oscillator frequency, the bypass capacitor may be shorted. In the event of oscillator failure or operation at completely wrong frequencies, disconnect the 1.8- μ fd. capacitor to eliminate the fine tuning circuit as a trouble source. The most likely defect in this circuit is a noisy or defective potentiometer or a bad diode.

This tuner, in addition to the novel fine-tuning circuit, also has a noise figure equal to most cascade tuners and almost as much over-all gain. Alignment and servicing is slightly simpler than for cascade turret tuners, since the neutralizing adjustment does not usually have to be repeated on different channels and there is practically no alignment required on the other r.f. circuits. Repairs of the turret segments, shaft, or other mechanical parts are the same as for other turret tuners except that, in this model, only a single segment is used for all tuned circuits.

BC-645 XMTR RECEIVER



15 Tubes 435 To 500 MC
Can be modified for 2-way communication, voice or code, on ham band 420-450 mc, citizens radio 460-470 mc, fixed and mobile 450-460 mc, television experimental 470-500 mc. 15 tubes (tubes alone worth more than sale price!) 4-7F7, 4-7HT, 2-7E6, 2-6F6, 2-955 and 1-VE316A. Now covers 460 to 490 mc. Brand new BC-645 with tubes less power supply in factory carton. Ship-
\$29.50

BRAND NEW

PE-101C DYNAMOTOR for BC-645, has 12-24V input (easy to convert for 6V Battery operation) only **\$7.95**
UHF ANTENNA ASSEMBLY, for BC-645 **\$2.45**
Complete set of 10 Plugs for BC-645 **\$5.50**
CONTROL BOX for above **\$2.25**
SHOCK MOUNT for above **1.25**
CONVERSION BOOKLET. Instructions for most useful surplus rigs **\$2.50**

SCR-274 COMMAND EQUIPMENT

ALL COMPLETE WITH TUBES Excellent Brand Type Description Used NEW
BC-453 Receiver 190-550 KC. \$14.95 \$18.95
BC-454 Receiver 3-6 Mc. 9.95 12.95
BC-455 Receiver 6-9 Mc. 9.95 13.50
BC-456 Modulator 3.45 4.95
BC-453 Receiver Control Box 1.49 1.95
BC-451 Transmitter Control Box 1.25 1.49
BC-696 Xmt 3-4 Mc (like new) 6.95 8.88
BC-457 TRANSMITTER—4.5-3 Mc. complete with all tubes and crystal. BRAND NEW. **\$7.88**
BC-458 TRANSMITTER—5.3 to 7 Mc. Complete with all tubes and crystal. BRAND NEW. **\$7.88**
BC-459 TRANSMITTER—7-9.1 Mc. complete with all tubes and crystal. BRAND NEW. **\$12.95**
ARC-5/T-19 TRANSMITTER—3 to 4 Mc. BRAND NEW complete with all tubes & crystal. **\$8.88**

110 Volt AC Power Supply Kit, for all 274-N and ARC-5 Receivers. Complete with metal case, instructions. Complete with metal case, instructions. Factory wired, tested, ready to operate. **\$11.50**
SPUN TUNING KNOB for 274-N and ARC-5 RECEIVERS. Fits BC-453, BC-454 and others. Only **49c**



LORAN APN-4 FINE QUALITY NAVIGATIONAL EQUIPMENT

Determine exact geographic position of your boat or plane. Indicator and receiver complete with all tubes and crystal.
INDICATOR ID-6B/APN-4, and RECEIVER R-9B/APN-4, BRAND NEW. only **\$48.49**
Complete Kit of Accessories for Above: PE-206 Inverter, Set of Plugs, Visor for Indicator, Operation Manual. ALL BRAND NEW. **\$49.50**

SPECIAL APN-9A LORAN Receiver Indicator, less tubes, NEW (demilitarized) **\$24.50**

TS-100/AP OSCILLOSCOPE

OUR LOW PRICE **\$33.33**
(worth \$750)
Can be used with linear sweep or general purpose test scope. Cables included. Also used with circular sweep as precision range calibrator. Self-contained in metal case 8" x 12 1/2" x 16" deep. For 110 V 50 to 1200 cycles AC. Excellent used, like new, with all tubes including crystals and C. B. Tube.

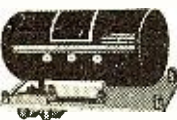

MOBILE TRANSCEIVER DYNAMOTOR

Model DM 35—Special Buy! Output 625 Volts DC @ 225 Ma. Input 12 1/2 V @ 18.7 Amps. DC. Size 8x4 1/4"x4". BRAND NEW. **\$13.50**
Excellent Used **\$9.25**

OTHER DYNAMOTOR VALUES:	Excellent	BRAND
Type	Input	Output Used NEW
DA-19-A 28V 11A	400V.400A	\$4.99 56.95
DM-28 28V	224V.07A	2.95 4.95
DM-32A 28V 1.1A	250V.05A	2.95 5.95
DM-33A 28V 5A	575V.16A	
	280V.7A	540V.25A 1.95 3.95
DM-34D 12V 2A	220V.080A	4.25 5.50
DM-37 25.5V 9.2A	625V.225A	5.95 8.95
DM-40 14V 3.4A	172V.138A	1.75 3.45
DM-53A 28V 1.4A	220V.080A	3.95 5.95
DM-64A 12V 5.1A	275V.150A	7.95
PE-73C 28V 20A	1000V.350A	8.50 11.50
PE-86 28V 1.25A	250V.050A	2.95 5.24
PE-186 28V 11A	400V.400A	6.95

FL-5 FILTER **79c**

TELEGRAPH KEY, NEW. **95c**



BC-442 ANTENNA RELAY
Wonderful Value! Consists of 3/4 amp 2" RF Ammeter (antenna current indicator), 0-10 scale, Transmitter-Receiver Switching relay, in aluminum case with associated components. BRAND NEW **\$2.49**

AN/APN-9 LORAN SYSTEM

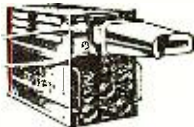

TERRIFIC BUY!
Value \$1200
OUR PRICE
\$169.50

Used in ships and aircraft. Determines position by radio signals from known xmitters. Accurate to within 1% of distance. Complete with tubes and crystal. Exc. used.

NEW VALUES—JUST ARRIVED!

AN/APR-4 RECEIVER only. 38 to 4000 Mc in 5 tuning unit ranges. High precision laboratory instrument used to monitor or indicate frequency of any signals within its range. Includes wide and narrow band IF strip selected from panel. Outputs provided for attachments to pulse analyzer, panadapter, etc. Input 115 V 60 cy. **\$69.50**
BRAND NEW
Tuning Units for above—each **\$39.50**

AN/ARN-5A AIRCRAFT RECEIVER. 11 tube superhet, 3-crystal control UHF for static-free reception. **\$24.95**
Exc. used with tubes

SCR-625 MINE DETECTOR
Locate buried metal objects up to 24" or more. Detects by means of tone. Operating wt. 15 lbs. Shpg. wt. 40 lbs. New
Complete with batteries **\$28.50**

SCR-522 2-METER RIG!
Terrific buy! VHF Transmitter-receiver, 100-156 Mc. 4 channels. Xtal-controlled. Amplitude modulated voice. They're going fast! Excellent condition.
SCR-522 Transmitter-Receiver, complete with all 18 tubes, top rack and metal case. **\$33.33**
COMBINATION Special
Receiver only, with all tubes **\$19.50**
Transmitter Only, with all tubes **\$22.25**
Accessories for above available.

EE-8 FIELD PHONES
Talk as far as 17 miles! Dependable 2-way communication at low cost! Ideal for home, farm, field. Up to six phones can be used on one line. Each phone complete with ringer. Originally cost gov. \$65.00 each. Excellent condition. **\$12.95**
OUR PRICE, EACH

DIRECTIONAL ANTENNA, 3-6 Mc.
Collapsible type, folds down to minimum size. NEW. **\$1.49**

BD-71 SWITCHBOARD, NEW.... **\$11.95**
BD-72 SWITCHBOARD, NEW.... **\$16.95**

DYNAMIC HANDMIKE, with "Press-to-talk" Switch, cord and plug—BRAND NEW, only. **\$2.95**

DYNAMIC HANDMIKE, aircraft, made by Telephonics Corp. Press-to-talk switch. BRAND NEW. **\$4.95**

DYNAMIC HEADPHONES, 600-ohm impedance, with large earphone cushions, cord and phone plug. BRAND NEW, special. **\$3.95**

BC-605 INTERPHONE AMPLIFIER
Easily converted to AC intercom set—ideal for home, office or factory. **\$4.95**
BRAND NEW, with original schematic. **\$4.95**
AC Conversion Instructions. **.65**

Hi-Fi DYNAMIC HEADSET with Cushions
Freq. Range: 40-14000 CPS. No Distortion. **\$7.95**
BRAND NEW

IMPEDANCE MATCHING Plug-in Transformer, 2000 to 600 ohms. Brand New. **97c**

MICROPHONES		
Model	Description	Excellent Used BRAND NEW
T-17	Carbon Hand Mike	\$5.45 \$8.95
T-30	Carbon Throat Mike	.39 .79
T-45	Army and Navy Lip Mike	1.33
T-24	Carbon Mike	5.95
TS-9	Handset	4.95
RS-38	Navy Type	2.79 4.95

HEADPHONES		
Model	Description	Excellent Used BRAND NEW
HS-23	High Impedance	\$2.25 \$4.95
HS-33	Low Impedance	2.79 4.95
HS-30	Low Imp. (featherwt.)	1.49 2.25
H-16/U	High Imp. (2 units)	3.75 7.95
CD-307A	Cords, with PL55 plug and JK26 Jack.	.99

SCHEMATIC DIAGRAMS For any equipment on this page, each. **65c**

Please include 25% deposit with order—Balance C.O.D. 50c Handling Charge on all orders under \$5.00. All shipments F.O.B. Our Warehouse, N.Y.C.

G & G Radio Supply Co.
Telephone: CO 7-4605
51 Vesey St., New York 7, N. Y.

234-258 MC RECEIVER

AN/ARR-2, BRAND NEW, tubes included: 7-9001, 3-6AK5, 1-12A6. Schematic included. Complete with 11 tubes; our low price!
\$9.99

With 28 V. 1.6A Dynamotor, complete. **\$2.98**

110 VOLT AC POWER SUPPLY KIT for above. **\$9.75**

BENDIX DIRECTION FINDER

For commercial navigation on boats and planes. Complete installation comprises:
MN-26-C Receiver, used, with 12 tubes. **\$16.50**
MN-26-C With 12 Tubes, BRAND NEW **\$24.95**
MN-20-E Rotatable Loop. **4.25**
MN-52 Azimuth Control Box. **2.95**
All necessary accessories for above in stock.

ARB NAVY RECEIVER-TRANSMITTER
Receiver 4 band 195-9050 Kc. or Transmitter 3000-9050 Kc and 2300-4200 Kc. 28 V Dynamotor. **\$88.50**
ALL BRAND NEW, complete.

NAVY RECEIVER TYPE ARB
Four Band. 195 to 9050 kc. Low Freq., Ship, Broadcast—40 to 80 meters. Includes tubes and dynamotor, for 24 volt operation. Easily converted for 110 V., 12 V., or 6 V. Schematic included. Excellent Condition. Overall: 8 1/4" x 7 1/4" x 15 1/4". Wt. 30 lbs.
COMPLETE WITH ALL TUBES, Special. **\$21.50**

BC1206-C BEACON RECEIVER
195 to 420 Kc. made by Setchel-Carlson. Works on 24-28 volts DC. 135 Kc. IF. Complete with 5 tubes. Size 4" x 4" x 6". Wt. 4 lbs.
BRAND NEW. **\$8.88**
Brand New, less tubes. **\$5.95**
USED, less tubes. **\$2.95**

BC-659 TRANSMITTER & RECEIVER
27 to 38.9 Mc F.M. Two preselected channels crystal controlled, 5 to 10 watts. Complete with speaker, tubes. Excellent Used **\$11.95**
POWER SUPPLY for above, 117 V 60 Cycles AC. Excellent used. **\$16.95**
Vibrator Supply for 6-12-24 Volts. **9.95**

BC-221 FREQUENCY METER
Special Buy! Complete with operating manual. LIKE NEW. **\$99.50**
BC-221 Modulated. **\$129.50**

BC-221 FREQUENCY METER CASE
Aluminum Case for BC-221 or TS-164 Freq. Meters. Shock Mounted. BRAND NEW. **\$3.99**
(add 50c for packing)
Original 1000 Kc Crystal for BC-221. BRAND NEW **\$8.45**

LM FREQUENCY METER
Crystal calibrated modulated. Heterodyne. 125 Kc to 20,000 Kc. With Calibration book. **\$49.50**
Exec. Cond. **\$49.50**
Loss Calibration Book **\$29.50**

ARC-5/R28 RECEIVER
2-meter Superhet, 100 to 156 Mc in 4 crystal channels. Complete with 10 Tubes. BRAND NEW **\$22.45**
110 V AC Power Supply Kit for above **\$9.75**

ARC-5/T-23 TRANSMITTER
100-150 Mc Includes 2-832A, 2-1625 Tubes. BRAND NEW **\$19.95**
SPECIAL Limited quantity ARC-5/T23 xmitters. BRAND NEW, less tubes. **\$7.95**
OFFER! Excellent Used, less tubes. **\$5.95**

ARC-5 MARINE RECEIVER-TRANSMITTER
Navy Type Comm. Receiver 1.5 to 3 Mc BRAND NEW with 6 tubes **\$16.95**
Navy Type Comm. Transmitter 2.1-3 Mc BRAND NEW with 4 tubes and MODULATOR for above, new, with tubes **\$12.45**
\$4.95

BC-603 FM RECEIVER. 10-channel push button tuning or continuous tuning, 20-28 Mc. Complete with speaker, tubes, squelch, 12-V Power Supply. Exc. **\$14.95**

BC-683 same as above except 21 to 38.9 Mc. **\$24.95**

BRAND NEW SPECIAL PURPOSE TUBES					
Type	Each	Type	Each	Type	
2042	\$4.95	304TL	8.95	837	\$3.15
2046	3.50	CRP-730A	3.45	1625	1.26
8D21	4.95	813	6.95	1626	1.26
RK-34	.39	815	2.99	2X2	3.39
RK65	7.25	826	.44	6A7	.35
2124B	.35	829B	7.50	6AG5	.33
VR105	.79	832A	5.95	6J6	.33
VR150	.79				

NEW! Cathode Ray Tubes NEW!
3CP1 **\$1.18** SBP4 **\$2.22**
3FP7 **1.18** 5CP1 **2.45**
5BP1 **2.22** 5FP7 **1.44**
6BP7 **2.22** 6FP7 **1.88**

WILLARD 6-VOLT MIDGET STORAGE BATTERY
3 Amp. Hour. BRAND NEW, 3 5/8" x 1-13/16" x 2 3/8". Uses Standard Electrolyte. **Only \$2.69**

2 VOLT BATTERY "PACKAGE"
1—2V. 20 Amp. Hr. Willard Storage Battery **\$2.79**
1—2V. 7 prong Synchronous Plug-in Vibrator **1.49**
1—Quart Bottle Electrolyte (for 2 cells) **1.45**
ALL BRAND NEW!
Combination Price. **\$5.45**

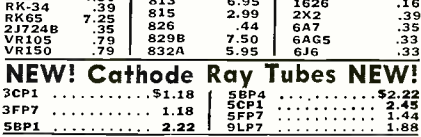

d'arsonval type

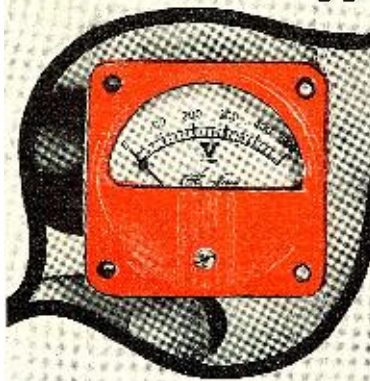

Low cost

miniature meters

IN COLORS! RED, BLUE or BLACK! 3% accuracy! Turning-coil movements. 1-5/8" square, mounts through 1-1/2" hole. Raised front ring, 1-1/2" O.D., permits mounting from behind panel to present round appearance, or, from front for square appearance.

Send for free Catalog No. 117!
It's loaded with hundreds of bargains!

TUNE-UP AND S-METER	\$3.95
MICROAMPS DC	\$5.95
0-50	\$5.50
0-100	\$5.50
100-0-100	\$4.95
0-200	\$4.50
0-500	\$3.50
MILLIAMPS DC	\$3.50
0-1	\$3.50
0-10	\$3.50
0-100	\$3.50
0-200	\$3.50
0-300	\$3.50
0-500	\$3.50
AMPERES DC	\$3.95
0-10	\$3.95
AMPERES RF	\$5.95
0-3	\$5.95
VOLTS DC	\$3.50
0-15	\$3.50
0-30	\$3.50
0-500	\$3.50
VOLTS AC	\$3.95
0-15	\$3.95
0-150	\$3.95



Arrow SALES, INC.
7035 LAUREL CANYON BOULEVARD,
NORTH HOLLYWOOD, CALIFORNIA

MANUFACTURERS!
Write for info on custom-made dials and movements. Quantity prices available.

NOW — faster, easier ball-bearing drive for GREENLEE chassis punches

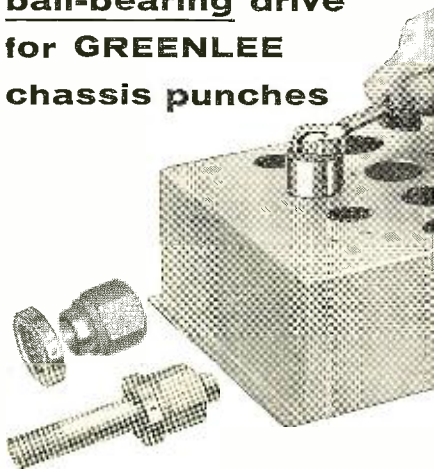

New GREENLEE Ball-Bearing Drive Nuts and Drive Screws reduce friction and make it easier than ever to cut smooth, accurate holes with GREENLEE No. 730 Round Radio Chassis Punches. The new faster drives are available for all round-type GREENLEE Punches sizes 11/16" through 2-25/32". Operate with ordinary wrench for quick socket openings, etc., in metal, Bakelite, or hard rubber.



GREENLEE TOOL CO.
1885 Columbia Avenue
Rockford, Illinois

BUILDING A HI-FI SYSTEM?

Send Us Your List Of Components For A Package Quotation

WE WON'T BE UNDERSOLD!

All merchandise is brand new, factory fresh & guaranteed.

AIREX RADIO CORPORATION

64 Cortlandt St., N. Y. 7, CO 7-2137

PARTIAL LIST OF BRANDS IN STOCK

- Alec Lansing
- Electrovoice
- Jensen
- University
- Acoustic Research
- Janszen
- Wharfedale
- Viking
- Concertone
- Bell • Lee • G.E.
- Weathers
- Harman-Kardon
- Eico • Pilot
- Sherwood
- Acrosound
- Fisher
- Bogen
- Dynakit
- H. H. Scott
- Pentron
- Ampro • VM
- Revere
- Wollensack
- Garrard
- Miracord
- Webster
- Collaro
- Thorens
- Rek-O-Kut
- Norelco
- Fairchild
- Pickering

Full Line of Cabinets

Transistor Code Oscillator

(Continued from page 47)

C_2 , C_3 , and C_4 are used to change the resonant frequency of oscillator. Several capacitors of different values were tried in order to obtain the best possible range of tones. An interesting note is that the volume control R_4 is essentially a tone control. An increase or decrease in collector voltage changes the frequency of oscillation. As shown in Fig. 1, one position of S_2 was left vacant so that the natural frequency of oscillator can be utilized. Capacitors in parallel with the primary give a greater variation of tones.

Volume control R_4 was tried in several different positions. It works best in the position shown, since the drain on the battery is low. R_1 and R_2 are base biasing resistors and are not critical. However, R_2 should be at least 10,000 ohms so that the feedback signal is not shorted to ground. The combination of R_1 and R_2 will be an additional drain on the battery. These should be large to reduce the drain. R_1 should be adjusted so that collector current will be between 0.2 and 0.5 ma.

Any value of C_1 will work as long as its reactance is low at the operating frequency. The only critical connection is the wiring of the secondary for feedback. It must be positive for oscillation, so it may be necessary to reverse the leads on the secondary if the oscillator doesn't work at first.

The battery was chosen because of its compact size, although one with higher voltage and of larger size can be used with an increase in the value of R_4 . As shown in Fig. 1, the key and headphones are in series across one half of the secondary. In this arrangement, keying does not interfere with normal operation of oscillator, since it does not appreciably change the load on the circuit.

Since this unit is easily constructed from ordinary parts, it can be used by anyone desiring an audio oscillator. It will work well in any situation where an audio signal is needed. It should have at least a 500-ohm load to work into to prevent erratic operation. See Fig. 2. Where the load circuit is lower than 500 ohms, a suitable resistor of about this value should be inserted in series with the output.

Fig. 2. The code oscillator described here should work into at least a 500-ohm load to prevent erratic operation.

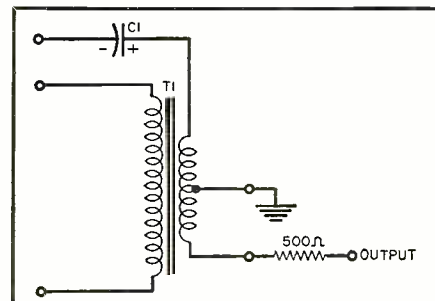

TV CIRCUITS PUZZLE

By JOHN A. COMSTOCK

(Solution on page 161)

ACROSS

1. The purpose of the video _____ is to increase the amplitude of the video signal frequencies.
6. A type of TV antenna in which the various elements are in a vertical plane and spread out fanwise from a lower junction.
8. The first series of circuits that receives the incoming signal immediately after the antenna.
9. In a color TV receiver, it is the function of the subcarrier oscillator to generate the _____ subcarrier frequency.
12. A regulator type of circuit that maintains the output of a TV receiver constant irrespective of a fluctuating input signal.
13. The _____ amplifier in a TV receiver enlarges amplitudes of sound frequencies.
14. In this circuit, the incoming signal is combined with a local oscillator signal to produce an i.f. signal.
16. The matrix amplifier in a color TV set is a combination of voltage divider _____ works and amplifier stages.
17. The function of the TV _____ is to snare minute voltages and currents from passing radio waves and transfer them to the lead-in.
18. The inner structure in the neck of a CRT.
19. An ion _____ is often placed around the neck of a picture tube to deflect ion particles.
23. When the image on a TV set is compressed or folded over at the top or bottom, this usually indicates the vertical _____ control needs adjusting.
24. The function of the vertical _____ control is to ad-

- just symmetry of image in vertical plane.
25. A crystal diode _____ often serves as video _____ in many TV sets.
26. The deflection _____ in a TV set deflects the electron beam in the CRT.

DOWN

2. The _____ amplifier in a color TV set amplifies and reproduces the three primary color voltages from the incoming signals.
3. The horizontal _____ control is used to adjust the symmetry of the image in the horizontal plane.
4. The _____ amplifier in an intercarrier TV set amplifies both picture and sound signals. (Abbr.)
5. The FM sound detector of a TV set.
6. When the image on the screen of a set lacks sharpness and the scanning lines are coarse, the _____ control is adjusted to pinpoint the electron scanning beam.
7. The horizontal _____ generator in a TV circuit operates at a frequency of 15,750 cps.
10. Circuit in audio section used to prevent amplitude variations.
11. A _____ is used in many of the circuits of a TV set as a control to vary voltage. (Abbr.)
15. A weak tube in the picture portion of a set will often cause the image to appear to be covered with _____.
19. A three-element tube often used as r.f. amplifier in the tuner of TV sets.
20. In a color TV set, the subcarrier signal is passed through a _____ shifting network before entering the "Q" demodulator.
21. Pertaining to the picture.
22. A control that is used to adjust image width.

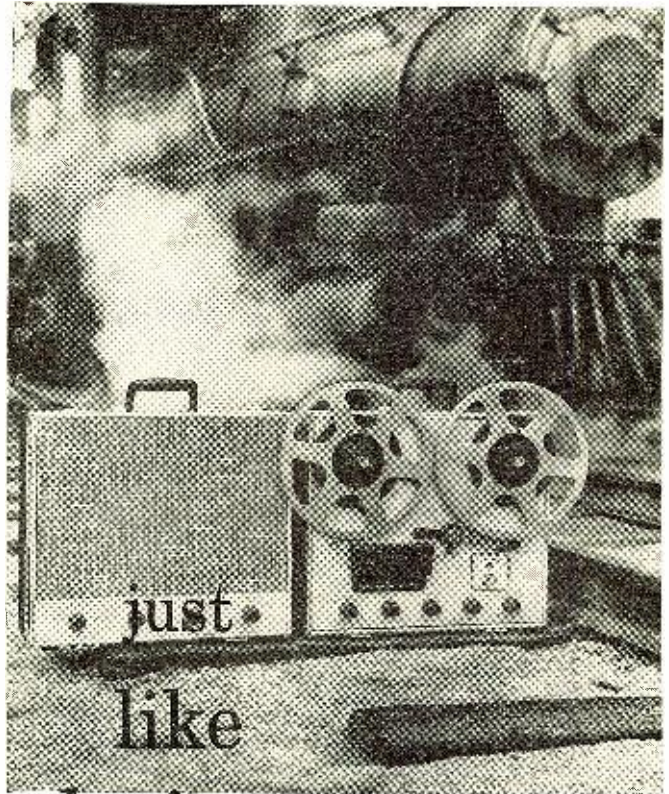
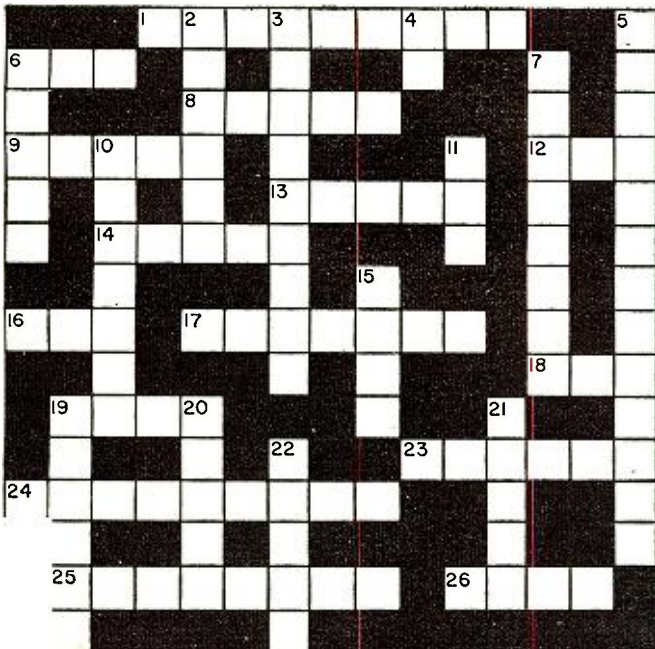

just
like
being
there!

Whether it's the clang and clash of a locomotive or just an ant crossing the tracks, the new AMERICAN CONCERTONE Series 60 records and plays it back with utmost fidelity. This superbly engineered instrument plays single track, full track or stereo...is portable or can be mounted on a wall or in a console. Five easy push-buttons for record, play, fast-forward, rewind and stop.



stereo series 60

Compare these features: Uses up to 10½" reels; Safety erase interlock; Direct Hysteresis Synchronous tape drive for 99.8% timing accuracy and two high speed take-up motors; Torque Control Switch for change from 7½" to 10½" reels; V.U. type meter for accurate recording levels.

Write for specifications to:

AMERICAN CONCERTONE

DEPT. A

655 WEST WASHINGTON BOULEVARD

LOS ANGELES 15, CALIFORNIA



THE PAUSE THAT PROTECTS YOUR RECORDS



exclusive feature of GLASER-STEERS GS-77 high fidelity changer

Now, the original brilliant performance of your records can be preserved for hundreds of additional plays. This requires an automatic record changer that handles records with a gentleness not yet achieved by any other changer on the market. The changer that accomplishes this... the new GLASER-STEERS GS-77.

TURNTABLE PAUSE is one dramatic reason why the GS-77 handles records more gently than any other automatic record playing mechanism. During the record-change cycle, the GS-77 turntable comes to a complete halt, and doesn't resume motion until the stylus has come to rest in the run-in groove of the next record. This completely eliminates the grinding action which occurs where records are dropped onto a moving turntable or disc.

The GS-77 **TONE ARM** affords further protection. Improved mass distribution and low pivot friction have so minimized arm resonance and tracking error that these flagrant causes of groove and stylus wear are now virtually eliminated. In addition, the arm has been so designed that stylus pressure between the first and top records in a stack does not vary more than 0.9 gram.

SPEEDMINDER goes still further -- for by simply setting the appropriate stylus into play position, the GS-77 automatically plays at the correct record speed, and in the micro-groove position, intermixes 3 $\frac{3}{4}$ and 45 rpm records regardless of their sequence in the stack.

The GS-77 is the perfect high fidelity record changer. It combines traditional turntable quality with modern automatic conveniences -- and it does this with incredible mechanical simplicity. No wonder

...audiophiles are switching to the new
GLASER-STEERS GS-77
\$59.50 less cartridge and base
(base illustrated, \$9.60)

RTN-5
GLASER-STEERS CORP.

20 Main Street, Belleville 9, N. J.

Please send me complete information on the GS-77.

NAME _____

ADDRESS _____

CITY _____ ZONE _____ STATE _____

Sound on Tape

By BERT WHYTE

IT WASN'T generally noted around the San Francisco or Los Angeles Audio Shows, but RCA dropped a bombshell in the pre-recorded tape business, and when the first shock-wave really hits, there is gonna be some people who will really flip! Without much fanfare, but through a series of conferences with many of the tape machine manufacturers, RCA exhibited a unique machine which will revolutionize the stereo tape field. This unit will, in time to come, probably be recognized as the tool which opened the door to low-cost mass stereo tape sales.

Now get this friends... the *Victor* unit was a specially designed machine which will accept a magazine-type tape cartridge. This cartridge is to contain about an hour's music and it will be played at a tape speed of 3 $\frac{3}{4}$ inches per second. The tape passes over a special 4-channel head which reproduces stereo from the two top heads and then without interruption at the end of the forward run, starts to play stereo from the two lower heads as the tape is neatly and automatically being rewound in the cartridge! Now hold on Jack, this isn't all... by means of a new type of extremely tiny gap in the magnetic heads, plus some equalization tricks the once-lowly 3 $\frac{3}{4}$ inch per second tape speed achieves a response to 15,000 cycles! And last, but hardly least... because of the slower tape speed and the "half-track stereo head" feature, an hour of stereo tape music is expected to cost no more than \$6.95 to \$7.95!

Among other ideas envisioned in the not too distant future would be "tape changers" in which a number of tape cartridges could be stacked like disc records and changed automatically. As of now there are no machines available, but the *Victor* folks are said to be tooling for production within the next year. *Shure Bros.* in Chicago have announced they will produce the four-channel head and *Ampex* is supposed to be working on a compatible design. Now there's that word again! Compatible in this case means the machine manufactured would have the ability to play today's normal reel-type tapes, as well as the new magazine variety. *Shure Bros.* in a press release takes this stand for compatibility as well, urging that before any further development is under-

taken on the cartridge machines that standards be set up which would protect the investment people now have in conventional machines and tapes.

As you can imagine, this idea has caused a furor in recording circles. All the idle speculation of what the stereo disc would do to the tape market is forgotten in the realization that now stereo disc and tape can both be mass media. Co-existence is more than ever assured and it is generally felt that it now will be a long time before either media makes obsolete the other.

I hardly need add, that this cartridge development coupled with the stereo disc, will set off a great new hi-fi boom, and obviously if you've been planning to buy new equipment or expand your old system, it would be most unwise not to "go stereo." And I don't think you need concern yourself about equipment obsolescence. Cool heads prevailed in the industry with the stereo disc, and you can be certain that when the tape cartridge comes, it will be compatible with your present equipment. I'll try to keep you posted on any new developments in this most intriguing new field.

WEBER INVITATION TO THE DANCE

Bamberg Symphony conducted by Heinrich Hollreiser. Phonotapes Cameo SC409. Price \$4.98. (11 minutes)

This is quite well done and with the popularity of the music should have a brisk sale. Hollreiser conducts with a light hand on the orchestral reins and lets the music speak for itself. His men seem to enjoy their work for their playing is vigorous and spirited. Soundwise this is big, close-up recording, very sharp and bright, perhaps even a shade too bright for some speaker systems. Directionality was very good as was depth positioning. Tape noise is the only bothersome flaw.

VOICE OF THE SEA
Cook Stereo Recording 5011. Price \$11.95.

This is, of course, taken from the original stereo tape from which Cook derived his now famous record of "The Voice of the Sea." This is among the first batch of Cook stereo tapes and I am afraid he was rushing to get them on the market. For although Cook has an altogether admirable sleeve-type tape box, there is an alarming lack of

RADIO & TV NEWS

any information, either on or in the box or on the tape reel. No doubt he will rectify this shortly.

Meanwhile we can enjoy anew, and greatly enhanced by stereo, the stentorian blasts of the Queen Mary's whistle, the highly directional coded whistle signals of the tugboats, the ear-splitting whine of the Navy cruiser turbines, the cone-bustin' blat of the Passamaquoddy fog horn, the atmospheric clang of buoy bells, and the shrill cries of the seagulls. The second half is devoted to the surf sounds and while their thunder and hissing surge is more impressive in the lack of distortion afforded by the stereo, directionality here is meaningless.

Having worked aplenty with binaural *Magnecorders*, with which Emory made most of his stereo tapes, I know the signal-to-noise problem those early magnetic heads imposed. There is tape hiss here, yes, but remarkably less than one would have imagined.

THE KING OF ORGANS

Bill Floyd at the Wurlitzer in the N. Y. Paramount. Cook 1150st. Price \$11.95.

This is the other side of the *Cook* stereo coin. This is his very latest stereo recording, made a few months ago with modern equipment in New York's famous Paramount Theatre. The organ at the Paramount is a real monster, requiring two 50 hp turbines to furnish the necessary 16,000 cubic feet of air per minute. It is noted for its huge augmented percussion battery.

Bill Floyd is the latest in a long line of distinguished organists who have presided over the instrument and he seems thoroughly at home with his massive friend. Floyd gives us some tasteful, tuneful arrangements of such numbers as "Anything Goes," "Swing Low Sweet Chariot," "I Married An Angel," "Body and Soul," "Fascinatin' Rhythm," and many others. Indeed, this is one of the most value packed tapes yet issued, there being so much tape on the reel that it threatens to spill over the edges and must be retained by a rubber band or adhesive of some sort.

This gargantuan organ makes an almighty sound, but the recording is less close up than we have come to expect from *Cook*. It is therefore somewhat lacking in brilliance. However owners of big speakers and lovers of the throbbing pedal, can hear some fabulous rumbles, way down in the sub-basement around 25-40 cycles. Directionality is very good for an organ and tape hiss was minimal.

THE GLENN MILLER SOUND IN STEREO

Members of the Original Glenn Miller Orchestra conducted by Maxwell Davis. Omegatape ST7026. Price \$10.95.

This is as close as you are ever likely to hear what the Glenn Miller Orchestra sounds like in stereo... at least on this side of Valhalla. *Omegatape* rounded up as many of the old Miller gang as they could and

Never Before Available at this LOW PRICE PRECISION, PORTABLE, BATTERY OPERATED, TRANSISTOR TAPE RECORDER



HI-QUALITY REPRODUCTION! **\$29⁹⁵**
WEIGHS ONLY 2 POUNDS!

plus \$1.25
pp. & hdg.

PRECISION ENGINEERED—Amazing, new, battery operated, portable, fully transistorized recorder, imported from West Germany, precision engineered to render same functions as machines costing 5 times as much.

FOR HOME, STUDENTS, BUSINESS—It will be the center of attraction at home for recording family get-togethers, capturing the magic of speech and song of family and friends—records radio, record and TV shows! Educators agree that students benefit greatly from studying with a tape recorder. Business men can pack it in brief case and take on trips to record letters, speeches, instructions, ideas; faithfully records verbal agreements, discussions. Perfect for recording interviews!

PENNIES TO OPERATE—The ingenious Tel-Tape records, plays back, erases—has variable speed controls! Operates on 4 small flashlight batteries available at any store for pennies. Simply press button and record.

Unconditionally guaranteed for 90 days against mechanical defects. Comes complete with sensitive microphone, head set and tape—\$29.95 plus \$1.25 pp. & hdg.

AVAILABLE ACCESSORIES

PATCHCORD — Plug in attachment for playback thru radio, TV or phonograph	\$2.00
STETHO HEAD-SET — Like a doctor's stethoscope. Lightweight. Leaves hands free for typing, etc.	\$6.95
REEL OF TAPE (225 ft.)	\$1.25
BATTERIES — Set of 4	80c

Send Check or Money Order. \$3.00 Deposit on COD orders.

10-DAY MONEY BACK GUARANTEE

FILNOR PRODUCTS, INC., Dept. M-30, 101 West 31st St., New York 1, N. Y.

NEW!!!

RECOTON-GOLDRING

VARIABLE-RELUCTANCE TURNOVER CARTRIDGE

Model RG-555
world-acclaimed ...
the unqualified leader
in design, performance
and flexibility

Model RG-555 Cartridge
Frequency response
33 1/3 rpm record with
compensation for Decca curve.

- New mu-metal shield and push-pull coil cancel hum.
- New cantilever system for high compliance and low effective mass.
- Frequency response — essentially flat 20 to 20,000 cycles per second.
- Weight less than 1 oz. complete.
- Finest quality construction throughout.

Recoton CORPORATION
52-35 Barnett Avenue Long Island City 4, N. Y.
In Canada: Quality Records, Ltd., Toronto

FOR THE FULL AUDIO SPECTRUM

Ultra Linear II

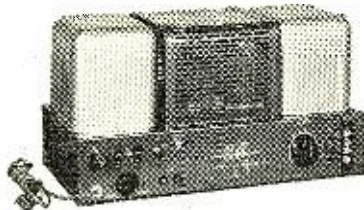

Do you hear the timpani in the symphony, or the Clarinet in a quartet? From vibrant restless lows to delicate highs, Ultra-Linear II reproduces the full audio spectrum the way it should sound . . . smooth, clean, natural. Graceful or tantalizing, music floats out with an airiness that spells fatigue-free listening hour after hour.

Acrosound Ultra-Linear II provides realistic amplification with new Hybrid* feedback that features complete stability and excellent square wave response on all types of output loads. Complete printed circuit, power transformer and choke are all made by Acro plus the new TO-600 output transformer especially designed for the circuit and constructed to the top standards of Acro's world famous quality. Simple layout provides top performance with only 2 hours of construction time.

*pat. pending.

Power output 60 watts; response 20 cps. to 20 kc. within 1 db. of 60 watts; less than 1% 1M distortion at 60 watts; hum level 90 db. below full output; 1.8 volts RMS for 60 watts output; output impedances are 4, 8, and 16 ohms; 7" x 15 1/8" x 8" h.; tubes used are 12AU7, 12AX7, 6Z34, 2-EL34 or 6CA7; variable damping from 0.5 to 15; weight 30 lbs.; Color:—Two-tone metallic brown.

AVAILABLE THROUGH LEADING DISTRIBUTORS \$79.50 complete kit (\$83.00 west coast); \$109.50 wired and assembled (\$113 west coast).

Acro Products, 369 Shurs Lane, Phila. 28, Pa.
Please send literature on illustrated Ultra-Linear II Amplifier.

Name
Address
City State

ACRO PRODUCTS COMPANY
369 SHURS LANE, PHILADELPHIA 28, PA.

then recorded them sticking as closely as possible to the original orchestration. As is befitting, the tape opens with the "Sunrise Serenade," and then continues with staples of the Miller repertoire such as the "Song of the Volga Boatman," "Moonlight Cocktail," "Anvil Chorus," "Chattanooga Choo-Choo," and others.

Unfortunately, with all the blandishments of stereo available, the engineers who recorded this largely negated this with one of the most dry, circumscribed sounds you can imagine. The miking was ultra-close and everything sounds clean enough, but there is strictly no "air" around the orchestra, no roundness, and absolutely no sense of depth. For those who like this sort of dry and close up recording I can report you will hear some great brass sounds and heavy percussion, especially that of the beat drum. If the powers that be at *Megatape* want to increase the sale of this tape, I suggest a judicious application of the echo chamber.

PORTS OF PLEASURE
Les Baxter and his Chorus and Orchestra. Capitol ZC20. Price \$12.95.

This stereo tape is just the opposite of the tape previously reviewed. Here is modern, big band, exotica at its stunning best. Here you have sharp, crisp, clean, close recording, but all is enrobed in spacious acoustics which affords a terrific sense of "liveness." Les Baxter has whipped up a batch of originals, highly programmatic and evocative as you can appreciate from titles such as "Tahiti—A Summer Night at Sea," "Shanghai Rickshaw," "The Pearls of Ceylon," "Harem Silks from Bombay," and others in the same vein. There is fine direction here and a good sense of depth too, along with adequate center channel "fill." The numbers may smack of Hollywood, but they make for pleasant listening and with the very large percussion battery which is used, the hi-fi man will have a ball.

Here is a new construction technique being used by Sylvania in their 6FH6 beam pentode (TV horizontal amplifier). The construction uses a unique type of grid, called the "Framelok" grid, in which the grid wires are drawn taut and are individually locked in place in "ladder" sequence on a one-piece window-like frame made of flat metal. The arrangement provides better grid alignment, improves stability and uniformity of characteristics.

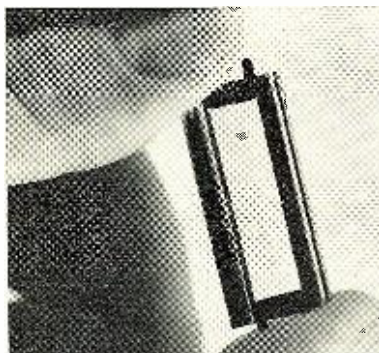

Want a box at the opera?



BUILD YOUR OWN!

A Bozak E-300 Kit—with Bozak Speakers, worthy associated equipment, and fine program material—is your lifetime pass to all the world's great music, at surprisingly low cost!

The Kit includes every needed part, assemblies in a few hours. As an infinite baffle, the E-300 requires the very finest speakers: for a wide-range 2-way system, the Bozak B-207A; add a Bozak B-209 Mid-Range and N-10102 Crossover Network for finest one-woofer 3-way performance.

Going stereo? A duplicate "300" will transform your livingroom into a living stage—your easy chair into the best seat in the world of music!

Hear the Bozaks at a Franchised Bozak Dealer. Write for literature.



The Assembled E-300 Kit

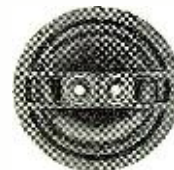

B-207A



B-209

N-10102



The R. T. BOZAK Sales Co.
Darien, Connecticut

RADIO & TV NEWS

Microphones for Recorders

(Continued from page 46)

duces a response the recorder will not record unless, of course, you are prepared to spend a lot more money and go out and buy a professional tape recorder. While expense of this kind will produce professional quality results, most home users will consider it hardly worthwhile, because results obtained with much less expensive equipment can be quite good. The condenser microphone is basically a high-impedance device that requires a special matching preamplifier that delivers the polarizing voltage needed for operation.

Ribbon Microphones

The ribbon type microphone uses a piece of foil between a magnet gap instead of a complete circular coil as in the moving coil. As such, it is basically a very low-impedance device having a low output sensitivity. The simple ribbon microphone has what is known as a bidirectional characteristic. It picks up back and front, but not on the sides (Fig. 4). The older ribbon microphones had a rather poor frequency response and, in addition, they were not very sensitive. But modern improved designs in ribbon microphones may have a sensitivity comparable to a good dynamic microphone along with a very smooth frequency response. Early ribbon microphones were quite fragile and required care in handling. In later types this problem has been largely overcome, although it is still not recommended that a ribbon be used outdoors without some sort of suitable wind protection.

The ribbon microphone requires a little more care in use, because one has to make sure that the sounds to be picked up are either in back or in front of the microphone, or they can be both. For example, a ribbon microphone can easily be used for picking up dialogue. Two people talking one to the other can stand a reasonable distance, as much as four feet or so, apart and have the microphone between them. Provided you know what you are doing, this can be a more comfortable arrangement than using a unidirectional or cardioid microphone, where the two people speaking have to be much closer to one another, or else each has to step up to the microphone when he says something.

For musical work, too, the ribbon can be useful although it is usually on the expensive side. Arranging a few of the instrumentalists on each side (or rather back and front) of the microphone and keeping people away from the blank sides will accommodate more people in a group than some other methods. If you have a wind instrument, such as a cornet, that makes much more sound than the other instruments, a ribbon can be useful in toning this down, by having the cornet player almost on the "edge" position of



RCA "SPECIAL RED" TUBES

10,000 hours—
minimum tube life



Recommended whenever uninterrupted service, unattended operation, and absolute reliability are demanded in industrial electronic equipment. Each tube is warranted for 10,000 hours, minimum life. Available at your RCA Industrial Tube Distributor.



RADIO CORPORATION OF AMERICA

Electron Tube Division

Harrison, N. J.

New characteristics booklet (RIT-104A) on RCA "Special Red" Electron Tubes—and other RCA Receiving-Type Tubes for Industry and Communications. For your free copy, write RCA Commercial Engineering, Section E-41-Z, Harrison, New Jersey.



NOW...

stereophonic

HIGH FIDELITY

components

by

Pilot

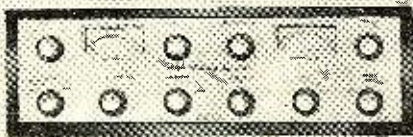

SP-215

Stereo Preamplifier

\$189.50

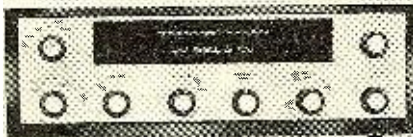

SM-244

Stereo Preamp and Amplifier

\$189.50

PRICES SLIGHTLY HIGHER IN WEST

For complete details, mail this coupon today.

Pilot Radio Corporation
37-06 36th St., L. I. C. 1, New York

Please send literature covering Pilot Stereo Components.

NAME _____

ADDRESS _____

CITY _____ ZONE _____ STATE _____

Manufacturer in electronics for over 39 years

the microphone. There are also some cardioid and other directional pattern microphones using a ribbon-type transducer, but their sensitivity is below that of "straight" ribbons.

There was a time when a microphone had to be big to be good—one might say, any good. But to achieve smooth response, particularly at the high frequencies, a microphone needs to be *small*. This is why the smaller modern dynamics and ribbons are usually so superior. But for the home recorder they are also less sensitive, so if you seek quality this good, you will probably need a preamplifier. Your problem is one of evaluating your needs to see if the expense is justified.

Most professional microphones come with an adapter for fitting to any particular type of stand that may be needed at the moment and also with a vibration shock mount that prevents the microphone from picking up vibration due to people walking across the floor and that kind of thing. This usually adds \$50 or so to the price of the microphone and is really something that the home user can do without. Simple precautions, such as standing the microphone on a foam rubber pillow, will serve the same purpose equally well and it is much less expensive.

With the wide range of microphones now available from a variety of manufacturers, there is no reason why anyone with a home recorder cannot have a lot of fun and expand the usefulness of his recorder, selecting a suitable microphone for the purpose at reasonably low cost. As an aid to the reader in summarizing some of the important characteristics of the microphones discussed, Table 1 is included. This table gives a number of important comparative characteristics of the various microphone types.

The foregoing suggestions, along with a little practice to get the "feel" of how things are done, will soon have you getting real fun and greater use and versatility from your present tape recorder.

A tiny new electronic component that may replace the ordinary tuning capacitor in some applications has been announced by Pacific Semiconductors. The new component, shown here with an ordinary capacitor, is the Varicap, a member of the semiconductor family. The useful property of the Varicap is that its capacitance can be varied by changing an applied bias voltage. Hence it can be used in place of reactance tube circuits for FM transmitters and receivers.

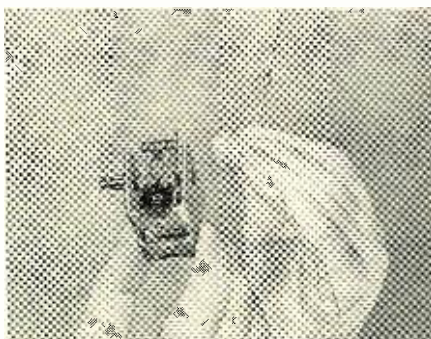

Operate your...

- tape recorder
 - P. A. system
 - portable TV set
 - hand tools
- FROM YOUR CAR, Boat or Plane!

with



INVERTERS

FOR CHANGING YOUR STORAGE BATTERY CURRENT TO

A.C. HOUSEHOLD ELECTRICITY ANYWHERE... in your own CAR, Boat or Plane!

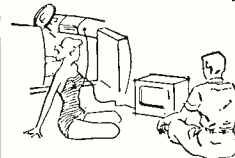

OPERATES PORTABLE TV SET directly from your car!

OPERATES

- TAPE RECORDERS
 - DICTATING MACHINES
 - PUBLIC ADDRESS SYSTEMS
 - ELECTRIC SHAVERS
- directly from your car!



MAKE YOUR CAR, BOAT OR PLANE "A ROLLING OFFICE!"



OPERATES

- RADIOS
- RECORD PLAYERS
- MIXMASTERS, ETC.

directly from your car!

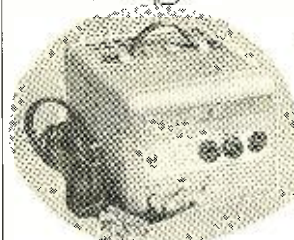

mounted out of sight under dash or in trunk compartment

ATR UNIVERSAL INVERTERS

Especially designed to change 6 or 12 volt D.C. to 110 volt A.C. 60 cycles.

- for...
- EXECUTIVES
 - SALEMEN
 - OUTDOOR MEN
 - POLICEMEN
 - REPORTERS
 - FIREMEN
 - PUBLIC OFFICIALS

MODELS 6U-RHG (6 volts) 125 to 150 watts. Shipping weight 27 lbs. List price.....\$89.95
DEALER NET PRICE.....\$59.97
12U-RHG (12 volts) 150 to 175 watts. Shipping weight 27 lbs. List price.....\$89.95
DEALER NET PRICE.....\$59.97

Write for literature on other Sizes and Models of ATR INVERTERS, priced as low as \$9.95 list.

SEE YOUR JOBBER OR WRITE FACTORY

- ✓ NEW MODELS
- ✓ NEW DESIGNS
- ✓ NEW LITERATURE
- "A" Battery Eliminators
- DC-AC Inverters
- Auto Radio Vibrators



AMERICAN TELEVISION & RADIO CO.
Quality Products Since 1931
SAINT PAUL 1, MINNESOTA, U. S. A.
RADIO & TV NEWS

Testing FM Tuners

(Continued from page 52)

Warm-up drift is usually corrected, in some measure, by the addition of temperature compensating capacitors and in some FM tuners an automatic frequency control system is used. In that case these tests should be performed first with the system operating and then without any a.f.c. correction. The difference between results will give an idea of the efficiency of this circuit.

To check oscillator drift accurately another oscillator of the same frequency range is required. It should be a unit that is crystal controlled. The two oscillator signals are connected to a crystal diode as shown in Fig. 5 and their output is then the "difference frequency." If both oscillators are at the same frequency, zero beating is possible. As the FM tuner warms up the beat signals will increase in frequency. To measure the beat frequency connect the detected signal to the vertical terminals of the oscilloscope and drive the horizontal scope sweep from a calibrated audio generator going up to at least 200 kc. One minute after the FM tuner is turned on, adjust its local oscillator to zero beat, indicated by no vertical deflection at the scope. As the local oscillator varies in frequency the scope will show sine-wave signals indicating the amount of frequency drift. Now the audio generator is adjusted to produce a single circle on the scope and the actual drift frequency is directly readable at the audio generator. Repeat measurements are taken every minute as the FM tuner warms up. After the first 10 minutes, readings are taken every 10 minutes for the first hour.

Oscillator drift due to voltage variation is measured in the same manner except that a *Variac* is used to change the line voltage. Usually the voltage is varied from 100 to 130 volts and the frequency drift is observed immediately after the voltage change. This frequency drift is expressed as the number of cycles of drift per 1% of line voltage change. Where an a.f.c. system is used, the drift due to changes in signal input level can be checked in the same manner. It is necessary to wait until the local oscillator has warmed up and then the signal generator, with standard modulation, is connected and the input level is varied in 5db steps from 11 to 11,000 microvolts. The observed frequency drift is an indication of the interaction between a.f.c. and a.v.c. circuits.

A number of other tests can be made on FM tuners but since they are either quite complex to perform or else do not yield any data of interest to the user they are omitted here. It is safe to say that any tuner which has successfully passed the tests described will be a really good piece of equipment and will give very satisfactory FM reception. —30—

SEND For FREE CATALOG

FOR FULL INFORMATION ON THE FOLLOWING ITEMS—OR SEE OUR PREVIOUS AD:

- PANORAMIC ADAPTER Navy RDP—60 cycle Used: \$34.95
 RADAR OSCILLOSCOPE 25 Tubes, BC-1268 New: 14.95
 LINK RECEIVER 30-40 MC, 10 tubes, FM R-1-UF New: 34.95
 I-208 FM Signal Generator—New: \$79.50
 Used: 59.50
 Raytheon REC.-TRANS. 150-172 MC—#21TR1A Used: 59.50
 AIR COMM. RECEIVER 200-500 KC, 60 cycle New: 18.95
 EE-8 FIELD TELEPHONE—Used, Checked 14.95
 BC-191 TRANSMITTER—100 Watt—New: \$34.95—Used: 24.95
 BC-375 TRANSMITTER—100 Watt—Used: 29.95
 SCR-625 MINE DETECTOR—Reconditioned 29.95
 TG-34 KEYS—Code Unit—Reconditioned 24.95

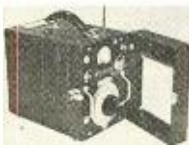

FREQUENCY METER

BC-906D—Absorption Type, using the dip of a 2" 0-500 D.C. Microammeter for frequency indication. Battery operated, with Chart and Manual—USED: \$7.95
 NEW \$9.95

BC-929 RADAR OSCILLOSCOPE

Makes an inexpensive station monitor—has horizontal, focus, sweep, and intensity controls. Tubes: 1 39P4, 2 6HG, 2 6SN7, 1 6GG, 1 6X5, 1 2x2, & Antenna Change Motor. Voltage required: 115 V 400 cycle & 24 VDC. For conversion, see QST August, '57.
 Used: \$9.95
 New: \$14.95

RANGE FILTER	SIDE BAND	PHONE PATCH
FL-8 U: \$1.50 Navy Type N: \$1.95	Loading Coil C-114—\$1.95	TRANS-FORMER C-161—\$1.95

SCHEMATICS AND MANUALS

Surplus Conversion Manual #1 or 2 \$2.50
 Surplus Conversion Manual—Command Sets 1.50
 TECHNICAL MANUALS—BC-603/604, BC-659, BC-745, BC-223, BC-312, Mark II Each: 3.00
 SCHEMATICS—BC-348, BC-224, BC-375, BC-603, BC-229/429, BC-230/430, Mark II Each: 1.00

RD-7/APA-23 RECORDER

Electro-Mechanical Device, intended to record radar search receiver Freq. & Time signals. Requires two minutes for sweep across recording paper. Automatic or manual operation. Operates on 80/115 V. 60-1200 cycle & 28 VDC. New: \$29.95

POWER SUPPLIES

TYPE No.	VOLTAGE	USED WITH: NEW	USED:
PE-110	115 V—60 cyc.	BC-669	\$49.50
PE-117	6 or 12 VDC	BC-659	12.95
PE-07	6 or 12 VDC	BC-620	12.95
RA-20	115 V—60 cyc.	BC-342/312	14.95
PS-274	115 V—60 cyc.	REC.274/ARC-5	18.95
PS-3050	115 V—60 cyc.	BC-603/683	17.95
PS-1206	115 V—60 cyc.	BC-1206	18.95

BC-1158 TRANSMITTER

Easily converted to 6 Meters. Frequency coverage 53.3 to 95 MC. 50 Watt RF Doubler Amplifier & Modulation sections complete with 4/815 and 10/125N7 Tubes. For conversion directions see CQ Magazine, January, '57 issue.
 Used \$29.95
 New \$39.95

Used \$29.95
 New \$39.95

TRANSFORMERS AND CHOKES

1080 VCT/190 MA—6.3/1.2: 6.3/3.6: 5V/4 \$4.95
600 VCT/100 MA—6.3/5A: 5/3A 3.95
240 VCT/75 MA—24/9A: 6.3/6: 6.3/3 1.75
1500 VCT/250 MA—6.3/3A: 6.3/5A: 5V/4.5A 7.95
700 VCT/150 MA—6.3/4.5A: 5V/3A 3.95
1890 VCT/12.6 MA—Tapped 2.5V/2A 3.95
1100 VCT/80 MA—7.5 VCT/3.25A 2.95
560 VCT/70 MA—6.3V/2.1A: 5V/3A 5.95
16 Volt 35 Amp. \$14.95; 9 Volt CT 35 Amp. 5.95	
5V/2 Amp 3 Windings: 5V/6A 2.95
TRANSFORMERS FOR SURPLUS EQUIPMENT:	
1200 VCT/200 MA—12.5/2A: 12.5/2A: 5V/3A—H-108 \$8.95
500 VCT/750 MA—24V/1A: 6.3V/1A—H-109 4.95
500 VCT/80 MA—24V/2A: 5V/3A—H-110 4.95
12.6/2 Amp. \$1.95; 24V/1 Amp. 1.95	
Dual Windings—12V/4 Amp or 24V/2 Amp. 5.95	
CHOKE 12.5 HY/100 MA 1.95
CHOKE 10 HY/250 MA 4.95
CHOKE 8 HY/150 MA 200 ohm Open Frame 1.25
CHOKE 5 HY/150 MA—85 ohm 1.50

Address Dept. RN • \$5.00 Order Minimum, & 25%

"EXPLORER" SATELLITE RECEIVER



Receive Radio Signals being transmitted by the U. S. Satellite—on approx. 108 MC. This Receiver is AM and Crystal Control on Six preset frequencies in the 108.3 to 110.3 MC range. Provides audio and band pass filter output of 90 and 150 cycles for aircraft instrument landing for which it was originally used. Complete with Ten Tubes: 1/12AH7, 2/12SG7, 2/12SR7, 1/12SQ7, 3/717, 1/12A6. Crystals and Schematic. Voltage required: 12 or 24 VDC & 220 VDC 80 MA. Size: 13 1/2" x 5" x 7". Also can be converted to FM Receiver 80 to 108 MC. Price—Used—Less Tubes & Crystals \$4.95
 NEW—Complete with Tubes and Crystals. 12.95
 Control Box—N: \$2.00. Cross Point indicators—U: 2.00
 Plugs for Receiver, Indicator, or Control Box—Ea.: 1.00

HANDSETS & MICROPHONES

HANDSET with Retractable Cord—Butterfly Sw., PL-68 & PL-55 Plugs H-22/U New: \$4.95
 TS-9 HANDSET—Push to talk Sw. No Plugs—Prices: Used: \$2.95 New: 4.95
 TS-13 HANDSET—Push to talk Sw., with PL-68 & PL-55 Plugs. Used: \$3.95 New: 5.95
 F-1 BUTTON CARBON MIC.—High Gain—For desk, car, hand use. Complete. New: 1.95
 RS-38 CARBON MIC. with PL-68 Plug. Used: 2.95
 T-17 MICROPHONE. New: \$6.95 Used: 3.95
 HS-23 HEADSET—2000 ohm, Rubber Cushion—Used: 2.95
 HS-30 HEADSET—Hearing Aid Type—250 ohm. 1.95



Gear-Head Motor

DELCO 50697—27 VDC Reversible PM Motor and Gear assembly in an aluminum case. Output speed is 80 RPM through a friction clutch to a double shaft 3/4" x 3/4" one side & 1/2" x 1 1/2" on the other. Size of complete assembly 3 3/8" x 2 1/4" x 4 1/4" excluding shaft. \$5.95
 For other types of Motors—send for our Free Catalog!

FM COMMUNICATION EQUIP.:



30-50 MC FM RECEIVER

Converted Gov't Surplus, 15 MC Spread, Specify Freq. Spread. Receiver illustrated at left, described below, prices at right. FM Receiver, continuous tuning & 10 preset channels, speaker, squelch, 10 tubes.
 NEW: \$29.95
 USED: \$24.95

BC-603: 20—27.9 MC—Used: \$14.95 New \$19.95
 BC-683: 27.9 to 38.9 MC Used 24.95
 12 V Dynamotor f/above Rec. Used \$2.95—New 6.95
 115 V 60 cycle Power Supply f/above Rec. New 17.95

BC-604 FM TRANS. 20-27.9 MC U: \$14.95; N: 10.95
 BC-924 FM TRANS. 27-38.9 MC U: \$14.95; N: 19.95
 BC-1335 REC.-TRANS.—27 to 38.9 MC with 6 or 12 VDC Power Supply Used: 24.95
 BC-620 FM TRANS.-REC.—20—27.9 MC U: 14.95
 BC-659 FM TRANS.-REC.—27—38.9 MC U: 14.95
 POW. SUP. 6 or 12 VDC f/BC-620-659 U: \$9.95
 N: 12.95

SCR - 522 REC. - TRANS. \$29.95

100—156 MC Crystal Control, 4 channel AM Voice, Preset Freq., 18 Tubes, Complete with Tubes, Schematic, and Conversion to 2 Meters. Used.

RECEIVER Chassis Only, Less Shifters \$14.95
 With Tubes \$14.95
 Less Tubes 7.95
 TRANSMITTER Chassis Only, Less Shifters \$18.95
 With Tubes \$18.95
 Less Tubes 7.95

\$11.95 DM-35 DYN. \$14.95
 USED, CHECKED (See details below) NEW

12 VDC DYNAMOTORS:

	NEW:	USED:
625 VDC—225 MA—DM-35 \$14.95	\$11.95
220 VDC—80 MA—DM-34 4.95	2.95
540 VDC—450 MA—DA-12 14.95	11.95
425 VDC—163 MA—WE-377 12.95	9.95
225 VDC—100 MA—D-402 8.95	5.95
230 VDC—90 MA—PE-133 4.95	
150 VDC—100 MA—DM-310X 2.95	
250 VDC—80 MA—DM-32-12V 4.95	
250 VDC—50 MA—DM-25 4.95	
500 VDC—50 MA—USA/0515 4.95	
24 VDC—1.5 A—USA/0515 4.95	
300 VDC—150 MA—CTR-124 5.95	
230 VDC—90 MA—DM-21 5.95	
275 VDC—150 MA—DM-64 8.95	
625 VDC—255 MA—DM-35 14.95	11.95

6 VDC DYNAMOTORS:

640 VDC—260 MA—Reconditioned by G.E. \$12.95
 420 VDC—260 MA—Reconditioned by G.E. 9.95
 Send us your Specifications and requirements for other type Dynamotors—Inverters—Generators!

Deposit on C.O.D.'s • Prices are F.O.B. Lima, Ohio

FAIR RADIO SALES 132 SOUTH MAIN ST. LIMA, OHIO

25 WORDS

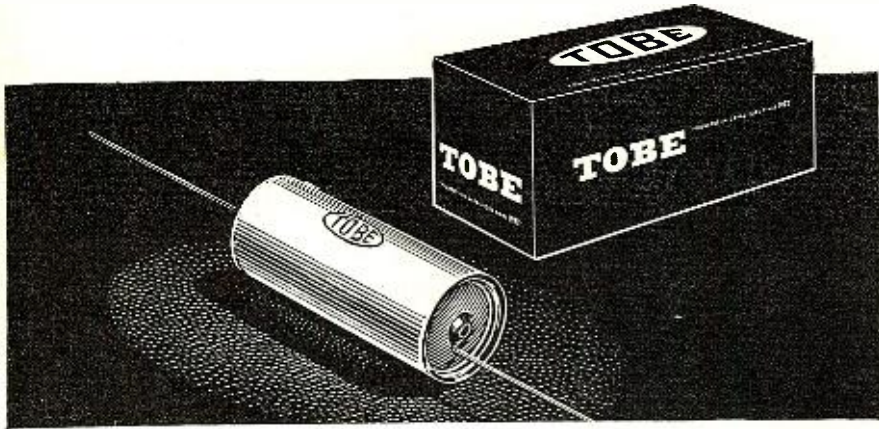

Tell Why You Like Tobe Service Capacitors

Your 25 words can win the Ford Ranch Wagon

And Here Are the TSC* Features to Help You Win • No substandard materials can possibly enter the manufacture of TOBE SERVICE CAPACITORS, because *everything* is quality-checked beforehand • Highest grade dielectric materials prevent voltage breakdown in service • TSC's are designed for high-temperature operation – will not dry out or deteriorate in service • Copperweld leads soldered directly to foil insure you against opens • Moisture-tight seals guard against shorts • Pigtail leads will not pull out or break off • No danger of hot soldering iron opening internal connection or melting sealing compound • TSC's will maintain specified capacity over entire operating temperature range • TSC's receive 100% quality-control inspection prior to shipment • Continuous production-line testing automatically rejects "duds" • Maintenance of large inventories on complete line means faster delivery to your TOBE DISTRIBUTOR and *you*.

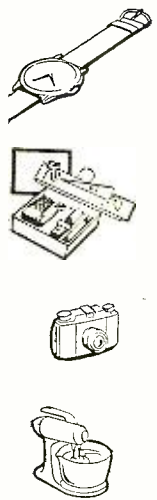

**HERE'S YOUR
ENTRY BLANK**

Tobe Deutschmann Corporation, Dept. C
2900 Columbia Avenue, Indianapolis 5, Indiana

"I prefer Tobe Service Capacitors in my work because _____

NAME _____

ADDRESS _____

CITY _____ ZONE _____ STATE _____

I enclose a Tobe boxtop

www.americanradiohistory.com

Mac's Service Shop
(Continued from page 64)

hatpin drawn through some of the coils and capacitors?"

"It indicates the coil or capacitor is variable. Notice, too, a single, short, heavy horizontal line means 'ground.'"

"How about these things that look like dominoes standing side by side?"

"You mean on that tube-layout pictorial? That is the connection panel for the push-button switches. Notice the letters of the alphabet are spaced across the top of the vertical rows of dots and a number is alongside each horizontal row. Each connection is thus indicated by a letter-number combination, and they are so indicated on the diagram. For example, see how this slider connects 'C₁' to either 'C₄' or 'C₆.' That makes tracing a circuit through the switches very easy."

"Are those standard American tubes?"

"No, but a slip of paper attached to the diagram says they can be replaced with American types. It says an American 1AJ4 will replace a European DF96; a 1AN5 replaces a DF97; a 1AH6 replaces a DAF96; a 3C4 replaces a DL96; and a 1AB6 replaces a DK96."

"Well, what are you going to do about the motorboating?"

"Easy, Sorrel-Top, easy! I think I'm getting a clue. See how the volume control and both tone controls are tied in more or less with the negative feedback loop from the voice coil to the bottom end of the volume control? Remember each of these controls affected the motorboating. Now if something were happening to shift the phase of the feedback, we could easily get just what we're getting."

"Maybe someone connected the feedback wire to the wrong side of the voice coil," Barney suggested.

"No; the set was working perfectly when packed for shipment home, and no one has touched it since it arrived. If we can find the cluster of resistors and capacitors used in the feedback circuit network, we may find something wrong there. Hm-m-m-m, this bunch has the right values."

As he talked, Mac was gently moving the resistors and capacitors in a group mounted on the output transformer. Suddenly the motorboating ceased and the radio played loudly and clearly.

"That was real tough," Mac said with a sheepish grin. "Two of the resistors were rubbing together and shorting out."

"OK, but let me say here and now you are welcome to all the foreign sets that come in. I've enough trouble when I have good service literature I can understand. Having to puzzle out the diagram or circuit as well as the symptoms is too, too much."

"You've got a point there. Something such as this makes us appreciate how good our service literature is. We

are going to have to charge more for working on foreign sets than we do for domestic receiver service where both our experience and our service literature help so much."

"Yeah, and I see a lot of those parts are of a special sort that would have to be obtained directly from the manufacturer. That's another headache that we have to face."

"Before a foreign manufacturer can expect to do a large business over here, he is going to have to make it easy to obtain special parts and see to it that the service technician has adequate service data. Maybe he could arrange to have his sets covered by the major service data publishers. We won't turn down any foreign set service, but I don't think it would be wise to solicit this kind of service. We seem to be getting plenty as it is. Within the last week we have had two German receivers, a Japanese receiver, and a Dutch tape recorder in here."

"One last question," Barney said as he wiggled his way into his shop coat. "What were you doing with the dictionary?"

"Trying to puzzle out the abbreviations on these trimmers. See, they are marked 'TOL, TVL, TVK, TVM, TOK, and TOM.' From what I can pick up in this German-English dictionary, I think 'TOL, TOM, and TOK' indicate the oscillator trimmers for the long-, medium-, and short-wave bands respectively. 'TVL, TVM, and TVK' must be the r.f. trimmers for the same bands."

"Ach! German abbreviations yet!" Barney muttered.

-50-

Glowing electroluminescent panels—man's newest source of light—glow with letters and figures in a new display system developed by scientists at the Westinghouse Research Laboratories. Bright enough for use in broad daylight and no thicker than a sheet of ordinary glass, the display shows only the exact information desired, without the need for dial watching or estimated readings. The new display is expected to find eventual use in such places as military aircraft, in certain industrial processes, and in the automobile of the future.



WIN THE FORD

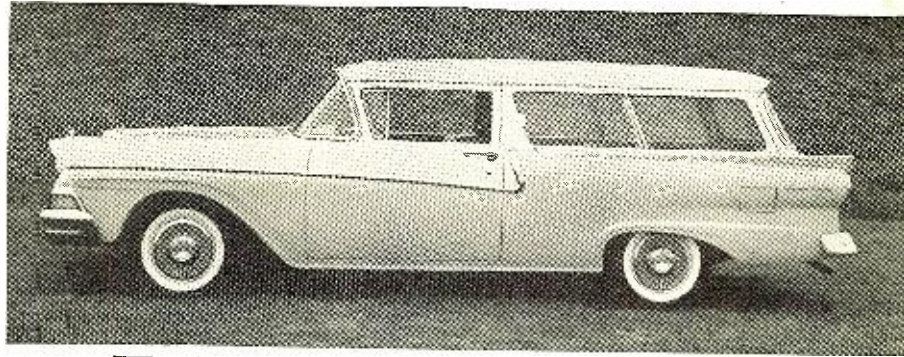

RANCH WAGON

Or one of 49 other valuable prizes



Here's all you do . . . In 25 words or less, tell us why you prefer TOBE SERVICE CAPACITORS.

Then, send your entry to us with the top from any TOBE capacitor carton, or the plastic box some TOBE capacitors are packed in.

That's all there is to it. Enter as many times as you wish, providing each entry is accompanied by a TOBE carton top or the plastic box. Use entry blank below. Additional entry blanks can be obtained from your TOBE DISTRIBUTOR.

Contest Closes May 30

Contest is open to all service-men over 21 years of age residing in the continental United States. Employees of the TOBE DEUTSCHMANN CORPORATION and their advertising agency are excluded. All entries become the property of TOBE DEUTSCHMANN CORPORATION. Decisions of the judges are final. In case of ties, duplicate prizes will be awarded. Contest closes May 30, 1958. Winners will be announced June 30th.



TOBE RADIANT

CAPACITORS

HERE'S YOUR ENTRY BLANK

Tobe Deutschmann Corporation, Dept. C
2900 Columbia Avenue, Indianapolis 5, Indiana

"I prefer Tobe Service Capacitors in my work because....."

NAME _____

ADDRESS _____

CITY _____ ZONE _____ STATE _____

RADIO ELECTRONIC SURPLUS

BC683 FM RECEIVER



27-39 mc. Equipped with 10 push buttons for selecting channels. Cont. variable tuning over the entire range. Unit complete with tubes, built-in loud speaker, squelch circuit, head phone jacks, schematic diagram on bottom of case. Approx. weight 34 lbs. Used, good.....\$12.50 each
12- or 24-volt D.C. Dynamotoreach \$3.95

BC603 FM RECEIVER

Same description as BC683 except that range is 20-27 mc. This unit complete with tubes. Like New.....each \$6.95
Manual with schematic for BC603 & BC604\$1.00 each

BC684 TRANSMITTER

(Used with BC683 receiver.) Used, good...\$4.95 each

DM35 DYNAMOTOR

Input 12 volt D.C., 18.7 amps. Output 625 volts, 225 ma. Used, good.....\$12.50 each

LM FREQUENCY METER

Crystal calibrated modulated Heterodyne. 125 Kc to 20,000 Kc. Excellent condition....\$22.50
With calibration book.....\$49.50

BC1335 2-CHANNEL FM TRANSCEIVER



30-39 mc. This unit is complete with 18 tubes operating from either 6 or 16 volts D.C. (Self-contained power supply). Crystal control, sensitive superhet circuit. Approx. dimensions 11" x 10" x 6". Approx. weight 24 lbs. Unit complete with tubes, schematic diagram and pre-setting instructions. Like New.....each \$22.50

BC659 FM TRANSCEIVER

29-40 mc, 2 channels, crystal control. Unit complete with tubes, built-in speaker and dual meter for testing filament and plate circuit. Approx. dimensions 16" x 13" x 7 1/2". Like New.....each \$6.95
Power Supply (PE120) for BC659 operates on 12-volt D.C. Like New.....each \$6.95
Manual with schematic for BC659.....each \$1.00

FIELD STRENGTH METER I-95-A



100-155 mc. Excellent condition....\$12.50 each

SIGNAL GENERATOR I-130-A



100-255 mc. Excellent condition.....\$12.95 each

AN/CRC-7 VHF TRANSCEIVER



With voice or transmit tone, used with air-sea rescue work. Crystal controlled. 140.58 mc. \$15.00 each (less battery)

44 POSITION STEPPING SWITCH



With automatic reset. 24 volt A.C. Dimensions 4 1/4" x 4 1/4" x 3" deep. Mfgd. by Wico. \$3.00 each
Five for \$12.50 postpaid

BC1033 BEACON RECEIVER

Used, good.....\$3.95 each

BC1333 BEACON RECEIVER

Used, good.....\$9.95 each

NO C.O.D.'s. REMIT FULL AMOUNT WITH ORDER. ALL PRICES F.O.B. PASADENA.

C & H SALES CO.

2176 E. Colorado St. - Pasadena 8, Calif.

A Day in the Shop (Continued from page 61)

the flyback which throws the 6AL5 into heavy conduction and produces a high voltage. Of course, in this case, pulling the 6AL5 restores the raster. If ever you see this fault in the house, *always* pull the 6AL5 before going farther."

A matched pair of .001- μ fd. capacitors has been wired in while the bench man is talking and on comes the raster. But, after a couple of minutes, off goes the picture leaving just a blank white raster. The bench man waggles the contrast control, sees jumping lines on the raster and observes, "The video amp is all right anyway." He explains that, if the video-amplifier tube were open, the raster would stay quite steady when the contrast control was rotated—"when you fiddle the control you vary the current through the tube and the control is always dirty enough to disturb the raster if you waggle it violently."

Next he lifts the first i.f. tube in and out of its socket, observes that there is no flicker at all on the raster and says, "Change the 6CB6's one at a time while I clean up the bench for a clear start after lunch." A few minutes later Jack triumphantly announces, "It's the first i.f. tube," but immediately afterwards comes a disappointed correction: "Whoops, there goes the picture again." After trying the second i.f. tube—this time waiting awhile before committing himself—he says with relief, "This time I have it." Checking the tube in the tester, he finds it is gassy but only after it has been on for a few minutes.

The bench man then plugs the tube back and shows how it can be tested for gas in the set. "See how the voltage is slightly more positive at the grid end of the grid resistor than it is at the bias-line end? That indicates gas in the tube. Notice that, on a strong signal, there is enough a.g.c. voltage to buck the gas-derived positive voltage and keep the set operating with a slightly washed out picture. That explains why the customer didn't complain about picture trouble as well as complete disappearance of the raster. He probably receives only the very strong local channel."

Raster Present but Dim

After lunch, the fourth set is ready for service, with a note on the job sheet "Insufficient brightness—high-voltage seems normal." "Probably the .03 on the picture tube (Fig. 3A) has gone down," says the bench man; and a quick check underneath confirms the guess, a charred resistor telling the tale. The .03- μ fd. capacitor, which filters pin 10 of the picture tube, shorts, burning up the 100,000-ohm resistor. The manufacturer recommends that, in replacing this capaci-

terado Trav-Electric MOBILE POWER CONVERTERS



Give You
110 A.C. HOUSE CURRENT ANYWHERE
You Drive or Cruise

For 6 and 12 Volt Car Batteries—Capacities: 15 to 200 Watts

LIST
\$12.95 UP

NO INSTALLATION

Just plug into cigar lighter on dash of car, truck, or boat—and away we go

- OPERATE PORTABLE TV,
- SMALL DO-IT-YOURSELF
- TOOLS WHEREVER NEEDED

One of the great conveniences of our electronic age



PORTABLE TV



DICTION

101 USES



ALL ELECTRIC SHAVERS



DO-IT-YOURSELF HOBBY TOOLS

See Your Electronic Parts Dealer or Jobber

terado COMPANY

DESIGNERS & MFRS. OF ELECTRONIC EQUIPMENT SINCE 1927

1058 RAYMOND AVE., ST. PAUL 14, MINNESOTA

IN CANADA: ATLAS RADIO CORPORATION LTD.-ONTARIO

30 Watt Hi-Fi Super Lin Kit

AMP-PREAMP with TRANSISTORIZED FRONT END

FREQUENCY RESPONSE: ± 1 db 10-40,000 cps.

TUBES: uses (1) 6AU6,

(1) 12AT7, (1) 12AU7,

(2) EL34's, (1) 5Y4-GP.

SHIPPING WEIGHT .66 lbs. FL-30

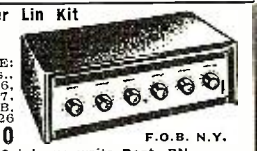

Sale Price.....\$42.00

Free Catalogue write Dept. RN

CUTICK ELECTRONICS HI-FI RADIO T.V. PARTS

171 Washington St., WOrth 2-5866, New York 7, N.Y.

INFRARED SNOOPSCOPES!

OPTICS • LAMPS TUBES • PARTS

Former "Top-Secret" Infra-Red Viewers For Seeing In Total Darkness - Undetected. Now Available For Civilian Applications!

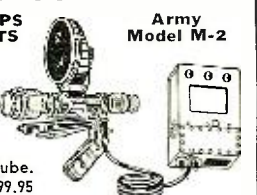

Bell & Howell—uses 1P25-A Image tube. Priced from \$50 to \$99.95



IMAGE TUBE POWER SUPPLY SNOOPSCOPE PART =1450-A
Power-pack for 1P25-1P25-A tubes (will also supply CV-147 tubes). Input 6 volts d.c. at only 0.33 ampere. Output 4,250 volts d.c. and additional focusing voltages. Operates from single 6-volt dry cell lantern battery. Size 4 1/2" x 3" x 8". Gov't cost \$92.00. NEW CONDITION. Complete, ready to use, only.....\$7.95 ppa.

INFRARED LIGHT SOURCE SNOOPSCOPE PART =1364-A

Input 6-volts, 5 amperes. 5 1/2" double glass filter. Projects a powerful beam of invisible radiation (free of all visible light) illuminates for infrared viewing or photography up to distance of 400 feet. STK. 2L-5459. BRAND NEW, only.....\$5.95 ppa.



TERMS: Cash With Order. Merchandise Guaranteed. Write today for FREE CATALOG

Contains detailed description, price list, and wide uses of units. Also large selection of other infra-red parts available at our amazing low prices.

McNEAL Electric & Equipment Co.
4736 Olive St., Dept. R-5, St. Louis 8, Mo.

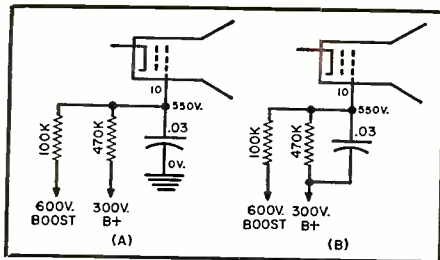

Fig. 3. Voltage across the .03- μ fd. unit in (A) caused frequent breakdown. Rewiring as in (B) relieved the stress.

tor, the new one should be wired in with the negative end connected to the 300-volt "B+" line instead of to ground, thus putting only 250 volts across the component instead of 550.

After replacing the capacitor in this way (and the resistor as well), it is noticed that we can only just fill the raster vertically. "Looks like insufficient drive from the oscillator," says the bench man. "It's usually the plate-load resistor of the 6C4 in this set." A measurement of the resistor seems to confirm the guess, as the 3.3-megohm resistor measures 4 megohms; but after replacing it, there is not much change in the height. Trying a new 6C4, the picture cannot lock. To be sure the new tube is not defective from birth, the bench man tries another new one, with the same result.

He notices that, as the vertical-hold control is slowly rotated, the picture suddenly reverses direction from a very rapid upward roll to a very rapid downward roll. "I wonder if there is a break in the track of the control, making the circuit go open before we get far enough to lock the picture?" An examination of the control shows this is indeed the case. See Fig. 4. "But why did the old tube work all right?" asks Jack. "Because it has characteristics such that it hits the right frequency with less grid-leak resistance, so the slider does not reach the crack by the time the picture has been locked; different tubes need slightly different circuit constants to work at a certain frequency."

One thing that keeps this TV business interesting is the fact that, whether in the shop or in the home, we learn something new almost every day. This one day we have been talking about was a typical one. Perhaps you got as much pleasure out of reading about it as we did from recalling it. As our wives point out only too often, whether we are writing, talking, or listening, they know what the topic is—"shop!"

Fig. 4. When this tube was changed and the hold control was readjusted, a break in the control track that had no effect before then suddenly became important.

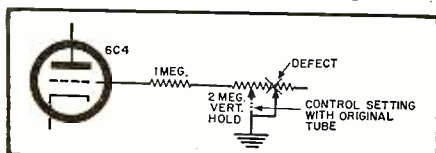

May, 1958



BRAND NEW TUBES—INDIVIDUALLY BOXED
MOST IN ORIGINAL STANDARD MANUFACTURERS CARTONS
ALL FULLY GUARANTEED FOR ONE YEAR

1A5GT	.79	6AK5	\$1.20	6K7	.90	12K7GT	.85
1A7GT	.82	6AK6	.74	6K8	1.15	12L6GT	.67
1B3GT	.73	6AL5	.49	6N7	1.15	12Q7GT	.79
1B5	.30	6AM8	.82	6Q7	.86	12SA7	.81
1C6	.25	6AN8	.89	6S4A	.54	12SC7	.84
1C7G	.30	6AQ5A	.53	6SA7	.67	12SF5	.74
1D6	.28	6AS5	.60	6SF5	.67	12SF7	1.06
1D7G	.30	6AT6	.53	6SG7	.95	12SG7	.87
1H5GT	.72	6AU4GTA	.85	6SH7	.92	12SH7	.94
1L4	.45	6AU6	.52	6SJ7	.94	12SJ7	.78
1LC5	.49	6AV6	.44	6SK7	.74	12SN7GT	.49
1LC6	.46	6AW8A	.88	6SN7GTB	.65	12SQ7	.67
1LH4	.60	6AX4GT	.66	6SQ7	.67	12V6GT	.58
1LN5	.46	6BA6	.50	6T4	1.12	12V6GT	.75
1N5GT	.48	6BA7	.92	6T8	.90	12X4	.45
1R5	.63	6BA8A	.91	6U8A	.85	14A7/12B7	.81
1S4	.77	6BC5	.57	6V6GT	.58	14B6	.88
1S5	.60	6BD6	.57	6W4GT	.65	14Q7	.78
1T4	.60	6BE6	.55	6W6GT	.76	17AX4GT	.96
1U4	.60	6BF6	.49	6X4	.46	17AX4GTA	.72
1U5	.55	6BH6	.62	6X5	.56	19AU4GTA	.92
1V2	.55	6BK5	.73	6X8	.85	25AX4GT	.25
1X2B	.66	6BQ6GA/6CU6	.90	7AU7	.69	25BK5	.75
2AF4	1.02	6BQ6GT	.90	7C4	.65	25BQ6GA/	.75
3AF4A	1.02	6BQ7A	.89	8CG7	.67	25CU6	.99
3AL5	.49	6BU8	.70	8CM7	.75	25CD6GB	1.59
3AU6	.58	6BZ6	.55	12AD6	.59	25L6GT	.62
3BN6	.75	6BZ7	.99	12AF6	.58	25W4GT	.73
3BU8	.71	6C4	.49	12AL5	.52	25Z5	.75
3CB6	.58	6C5	.72	12AQ5	.61	25Z6GT	.75
3CS6	.58	6C6	.89	12AT6	.48	26	.78
3DT6	.54	6CB6	.55	12AT7	.74	27	.71
3V4	.59	6CD6GA	1.48	12AU6	.58	34	.25
4BC8	1.03	6CG7	.61	12AU7A	.61	35A5	.82
4BN6	.75	6CG8A	.80	12AV6	.46	35B5	.66
4BQ7A	1.01	6CM7	.69	12AX4GTA	.72	35L6GT	.65
4BC5	.58	6CS6	.57	12AX7	.68	35W4	.39
4BU8	.71	6CU6	.99	12B4A	.72	35Y/51	.35
4BZ7	1.03	6D6	.92	12BA6	.55	35Y4	.66
4CB6	.56	6DB5	.69	12BA7	.85	35Z3	.66
5AM8	.79	6DG6GT	.67	12BD6	.56	35Z5GT	.49
5AN8	.90	6F5	.78	12BE6	.57	39/44	.25
5AQ5	.54	6F6	.90	12BF6	.49	50X6	.80
5CG8	.81	6F6GT	.71	12BH7A	.77	50Y6GT	.79
5J6	.71	6G6G	.99	12BK5A	.91	50Y7GT	.78
5U4GB	.55	6H5	.70	12BL6	.58	75	.49
5U8	.84	6J5	.65	12BQ6GTB	1.19	75	.95
5V3	.90	41	.77	12C5/12CU5	.69	80	.60
5Y3GT	.39	42	.75	12CN5	.49	80	.60
5Y4GT	.64	43	.82	12CX6	.56	83	.85
6A7	1.01	45Z3	.30	12DK7	\$ 1.11	84/6Z4	.64
6A8	.98	50C5	.53	12DQ6A	.81	89	.35
6AB4	.57	50L6GT	.65	12EM6	.75	117N7GT	2.25
6AF4A	.95	6J6	.75	12F5	.75	117Z3	.67
6AG5	.65	6J7	.90	12K8GT	.69	117Z6GT	1.10
		6K6GT	.52				

EXTRA—SPECIAL 10% DISCOUNT ON 100 TUBES OF ONE TYPE

F.O.B. New York City—25% Deposit required with mail orders—or send full remittance to save C.O.D. charges.
 Rated Firms—Net 10 Days. All types subject to prior sale and price changes.

NUCLEAR-ELECTRONICS CORPORATION
 DEPT. E—383 CONCORD AVE. NEW YORK 54, N. Y.



-- then you need us!

GET STARTED RIGHT by writing for our 24 page catalog illustrating over 30 business forms and systems designed specifically for TV-Radio Service.

ON SALE AT YOUR PARTS JOBBER

Oelrich Publications • 4308 N. Milwaukee • Chicago 41, Ill.



college grads get ahead faster!

... have higher incomes... advance more rapidly. Grasp your chance for a better life. Share rewards awaiting college men. Important firms visit campus regularly to employ Tri-State College graduates. Start any quarter. *Approved for Vets.*

Bachelor of Science degree in 27 months

Complete Radio Engineering courses (TV, UHF, FM, Electronics). Also Mechanical, Civil, Electrical, Chemical, Aeronautical Engineering. In 36-months a B.S. in Business Administration (General Business, Accounting, Motor Transport Management). Superior students faster. More professional class hours. Small classes. Enrollment limited. Beautiful campus. Well-equipped labs. Prep courses. Enter June, Sept., Jan., Mar. Earnest capable students (whose time and budget require accelerated courses and modest costs) are invited to write Jean McCarthy, Dir. Adm. for Catalog and book "Your Career in Engineering and Commerce."

TRI-STATE COLLEGE
 1658 College Ave. Angola, Indiana

BARGAIN HUNTING? TV SERVICEMEN!
 Write for SENSATIONAL CATALOG
HENSHAW RADIO SUPPLY
 3619 TROOST KANSAS CITY, MO.

THE BIGGEST \$1 DOLLAR SALE IN OUR HISTORY!

SAVE \$3 to \$30 ON EVERY POLY-PAK! Exclusive with us!

FREE! PICK ANY \$1 POLY-PAK FREE WITH EACH \$10 ORDER!

\$1 POLY-PAKS

- 20 ROTARY SWITCHES. Asstd. gangs, insulation, contacts. Wide variety. Wt. 3 lbs. Reg. \$18.
- 60 TUBULAR CONDENSERS. Paper, molded, oil, porcelain, .0002 to .25 mf.; to 1,000V. Wt. 2 lbs. Reg. \$12.
- 1 MINI-METER. 1 3/4" round. 0-6 amps. AC. Chrome face. Reg. \$9.
- 8-PC. NUT DRIVER SET. Plastic handle, 3/16, 7/32, 1/4, 5/16, 11/32, 3/8, 7/16" sockets, wrenches in plastic case. Wt. 1 lb. Reg. \$3.
- 50 ASSORTED KNOBS for radio, TV, appliances. Bakelite, plastic. Wt. 2 lbs. Reg. \$9.
- 100 RADIO PARTS. Surprise assortment. Reg. value over \$15. Wt. 3 lbs.
- 2 PNEU TRANSISTORS. Scoop! Famous make, worth many dollars each! While they last.
- 65-PC. CONDENSER SPECIAL. All types asstd. Molded, paper, ceramic, oil, mica, variable, discs. Reg. \$13. Wt. 2 lbs.
- 15-PC. TWIST DRILL SET. 1/16 thru 3/4" x 64ths; in graduated plastic holders. Reg. \$4.
- 40 SUB-MINI RESISTORS. Only 1/4" long. 20 values; 15 ohms to 10 megs. Color-coded. Reg. \$6.
- 10 ELECTROLYTICS. Singles, duals, triples, 1P types, to 500 mf. Wt. 3 lbs. Reg. \$14.
- 70 MICA CONDENSERS. Silver, 5/62 incl. 30 values; .0001 to .01 mf. to 1,000V. Wt. 1 lb. Reg. \$5.
- 75-PC. RESISTOR SPECIAL. All types asstd. Power, carbon, transistor, precision. 30 values. Worth \$13. Wt. 1 lb.
- 10 "POLY" BOXES. Clear plastic, hinged, w/ snap locks. Asstd. sizes. Reg. \$2.
- TV MIRROR. Sylvania. Stainless steel, 12 x 8". See TV picture while servicing. Many home uses, too. Wt. 1 lb.
- 40 HI-Q CONDENSERS. Finest porcelain types. Reg. \$8.
- 60 TERMINAL STRIPS & BOARDS. Wide variety solder lug, binding, etc. Wt. 1 lb.
- 40 POWER RESISTORS. Wavy, candohm, vitreous, sand-coated. 15 values; 5 to 50 W; 3 to 11,000 ohms. Wt. 2 lbs.
- 50 PLUGS & RECEPTACLES. Audio, power, chassis, panel & spkr. types. Wt. 2 lbs. Reg. \$12.
- 40 MOLDED CONDENSERS. wide assortment, including ois, porcelain, plastic. Reg. \$8.
- "FLEA POWER" MINI-MOTOR. Permanent magnet, 1 1/2 to 3 VDC to operate. 3,000 rpm. Wt. 1 oz.
- 40 TUBE SOCKETS. Wide asst. mica, printed, shield-based incl. Reg. \$8. Wt. 2 lbs.
- 150 RESISTORS. 30 values; 1/2 to 2 W. Reg. \$10. Wt. 2 lbs.
- CRYSTAL MIKE. Post-are-stamp size. Crisp! \$5 to 8,000 cps. Reg. \$5.
- 4 FILTER CHOKES. up to 200 ma. Strap mfg. Wt. 2 lbs. Reg. \$5.
- POPULAR DIODES. Crystals and silicones. Some worth \$10!
- 6 TRANSISTOR SOCKETS, with mounting plate.
- 10 POWER SWITCHES. 115 VAC. Asstd. SPST, DPST, DPDT. Shop must!
- 60 COILS & CHOKES. RF, IF, Ant. Large variety, incl. slug-tuned. Wt. 2 lbs. Reg. \$15.
- 20 VOLUME CONTROLS. Singles, doubles; asstd. slugs, shafts. Reg. \$13. Wt. 2 lbs.
- 3 LBS. HARDWARE, approx. 2000 pcs. Asstd. screws, brackets, etc. Reg. \$8.
- 2 SUB-MINI SOLENOIDS. 1 x 5/8 x 5/8". Change elec. energy to mech. 12 VDC @ 400 ma actuates plunger. Wt. 2 oz. Reg. \$5.
- 2 GERMANIUM DIODES. Glass-sealed, w/long leads. Reg. \$4.50.
- 40 PRINTED CIRCUIT PARTS. Diodes, carbon, precision resistors; chokes; molded, ceramic condensers; boards. Reg. \$15.
- SEVEN 25-FT. ROLLS WIRE. Asstd. colors, stranding, insulation. 218 to 24. Wt. 2 lbs. Reg. \$3.75.
- 20 Raytheon KNOBS. Precision, anti-static! Instrument types, metal insert, w/set-screws. Wt. 1 lb.
- 40 T. TRANSISTOR XFMRs. UTC "councer" type. Interstage; 1 x 3/4 x 3/4". Imp. ratings; utility tuner, diode, all parts, directions. Reg. \$3.50.
- 20 PRINTED CIRCUITS. assorted. Integrals included. Reg. \$7.
- WORLD'S SMALLEST RADIO KIT. 2 1/2 x 1 3/4 x 3/4" w/permeability tuner, diode, all parts, directions. Reg. \$3.50.
- 5 DIAL-LITE ASSEMBLIES. Asstd. colored jewelers' mini bulbs. Reg. \$3.50.
- 0-60 MINUTE TIMER. Darkroom, shop use. Sounds alarm. W/ glass, chrome bezel. Wt. 3 lbs. Reg. \$7.
- 100 CERAMIC CONDENSERS. Tubular, popular makes. Wt. 1 lb. Reg. \$12.
- 40 DISC CONDENSERS. For transistor & sub-mini work. Reg. \$5.
- 40 PRECISION RESISTORS. carbonyl & Ww. 1/2" asstd. 3 1/2 W. to 1 meg. Wt. 1 lb. Reg. \$25.
- 10 TIMING MECHANISMS. 10-second, intricate gearing. Wt. 2 lbs. Reg. \$3 ea.
- 60 HI-Q RESISTORS. Finest made! LRC, A-B. 30 values; 15 ohms to 10 megs; 1/2 to 2 W. 1/2". Wt. 1 lb. Reg. \$12.
- 20 FERRITE TUNED COILS. Ant. osc. IF. Wt. 2 lbs. Reg. \$15.
- 40-FT. "ZIP" CORD. AC/DC line, speaker cable, 2 conductor. State color. BLACK, BROWN, WHITE. Wt. 2 lbs.
- 5 ROLLS "MICRO" WIRE. 25 ft. roll. Ideal for transistor & sub-mini work. Hi-temp. nylon, glass. 24 to 30. Reg. \$5.
- 250-FT. HOOKUP WIRE. asstd. colors, insulation, stranding. 25' lengths or longer. Wt. 3 lbs.
- MINI 0-99999 COUNTER. By Veeder-Root. Double-ended shafts, Tape recorders, motors, etc. Reg. \$5.
- MINI SIGMA SENSITIVE RELAY. 10,000 ohms SPST with R/C assembly. Reg. \$6.50.

HOW TO ORDER Check items wanted. Return entire ad w/check or M.O. including sufficient postage, excess returned. C.O.D. orders, 25% down; dated, net 30 days. Print name, address, amount money enclosed, in margin. (Canada postage, 45c 1st lb., 28c ea. addl. lb.) EXPORT ORDERS INVITED



Basic Counting Circuits (Continued from page 49)

add more resistance in the grid circuit of all right-hand tubes. This drives the right-hand grids positive and switches each stage to the zero condition—left-hand tube cut off and right-hand tube conducting.

If a negative pulse is now applied to the input of the first stage, it will drive this stage to the one condition. The neon light of the first stage is now on, indicating that one pulse has been applied to the input. If another input pulse is applied, the first stage will switch back to the zero condition, and its neon light goes out. As the first stage returns to the zero condition, its right-hand tube conducts and its plate voltage decreases. This feeds a negative pulse into the second stage, switching the latter to the one condition. The light in the second stage thus comes on to indicate that two pulses are now stored in the circuit.

Table 1 shows the condition of each stage after each input pulse. It also shows that the neon lights which are on at any given time indicate the total number of pulses stored in the circuit. In the table, the flip-flop stages are listed in reverse order (4th, 3rd, 2nd, and 1st) to show that the conditions of these stages represent the binary number stored in the circuit. For example, the conditions are 0011 after the third input pulse, and 0011 is the binary equivalent of the decimal number 3.

As shown at the bottom of Table 1, all four stages are back to their starting conditions after the 16th input pulse. At this time, the right-hand tube of the fourth and final flip-flop stage conducts and provides a negative pulse at the output terminal of the complete chain. The entire circuit therefore produces one output pulse for every 16 input pulses. The output pulse may be fed into a mechanical counter having numbered discs like those used to indicate automobile mileage.

As pulses 17, 18, 19, etc. are applied, the circuit will repeat the switching actions listed in Table 1. The circuit will store the input pulses until 16 more have been accumulated and will then provide another output pulse to the mechanical counter. At any given time, the total number of input pulses is therefore indicated by the counter and the neon lights. The number indicated by the counter should be multiplied by 16, since it receives only one pulse for every 16 applied to the input. To this product should be added the number of pulses still stored in the circuit as indicated by the neon lights.

Applications

The circuit shown in Fig. 4 can be extended to any number of stages. The number of stages required is determined by the rate at which the mechanical counter can operate. Most

"NOISE" BIG 3

Beware Of Cheap Substitutes!



NO-NOISE NEW RUBBER COAT SPRAY
 • Insulates where applied
 • Protects indefinitely
 • Prevents arcing, shorting, corrosion
 • Waterproofs thoroughly
 • Non-inflammable
 • Contains no plastic
 6 Oz. Spray Can
\$3.25
 Net To Servicemen



NO-NOISE VOLUME CONTROL and CONTACT RESTORER
 • Cleans • Protects • Lubricates
NOT A CARBON TET SOLUTION
 2 Oz. Bottle 6 Oz. Spray Can
\$1.00 \$2.25
 Net To Servicemen



NO-NOISE TUNER-TONIC
 With PERMA-FILM
 • Economical—a little does a lot.
 • Cleans, lubricates, restores all tuners, including water type.
 • Non-toxic, non-inflammable
 • Use for TV, radio and FM
 6 Oz. Aerosol Can
\$3.25
 Net To Servicemen

ELECTRONIC CHEMICAL CORP.
 813 Communipaw Avenue Jersey City 4, N. J.



Only from famous COYNE do you get this modern up-to-the-minute TV Home Training. Easy to follow instructions—fully illustrated with 2150 photos and diagrams. Not an old Radio Course with Television tacked on. Includes UHF and COLOR TV. Personal guidance by Coyne Staff. Practical Job Guides to help you EARN MONEY QUICKLY IN A TV-RADIO SALES AND SERVICE BUSINESS—part time or full time. COSTS MUCH LESS—pay only for training—no costly "put together kits."

SEND COUPON FOR FREE BOOK
 SEND COUPON BELOW for Free Book and full details including EASY PAYMENT PLAN. NO COST OR OBLIGATION—NO SALESMAN WILL CALL.

B. W. COOKE, JR. **COYNE ELECTRICAL SCHOOL** FOUNDED 1899
 PRES.

A TECHNICAL TRADE INSTITUTE OPERATED NOT FOR PROFIT
 500 S. Paulina Dept. 58-H6 Chicago 12, Illinois

COYNE ELECTRICAL SCHOOL
 Television Home Training Div.
 500 S. Paulina St., Chicago 12, Ill., Dept. 58-H6
 Send FREE BOOK and details of your Television Home Training offer.

Name _____
 Address _____
 City _____ State _____

commercially available counters will not operate much in excess of about 20 counts per second. The number of flip-flop stages should therefore be sufficient to reduce the frequency of the input pulses to 20 per second, or less, at the output.

Circuits of the type shown in Fig. 2 are commonly used in nuclear instrumentation for counting the pulses produced by geiger and scintillation counters. One such scaling unit is shown in Fig. 1. Such circuits are also used for counting objects passing on an assembly line or conveyor belt. In this application, a phototube provides an input pulse to the flip-flops as each object to be counted passes by.

Similar circuit arrangements are used in automatic packaging machinery. After the desired number of units have been packaged, as indicated by the number of pulses produced by a phototube, an output pulse is produced by the last flip-flop stage. This pulse is used to stop the packaging action or to activate a conveyor which brings the next container into the packaging position.

The Cable Tracer-Checker

(Continued from page 42)

ters lend themselves to such an "automatic" numbering system, it is possible with any voltmeter to determine at once by the voltage reading obtained, the two ends of any one conductor without any reference to others.

If any of the conductors in a cable is open, you simply do not get a reading for that conductor. If any two conductors are shorted together inside the cable, these two will cause the voltmeter to read the same voltage, and the voltage readings for other conductors will be incorrect, with one exception. Thus, if conductors 2 and 3 (Fig. 3B) were shorted, touching conductor 1 with the positive meter lead would give a reading of 1.25 instead of 1; number 2 would read 2.5; number 3 would also read 2.5; number 4 would read 3.75; and number 5 would read 5.

It is not necessary to use an extra wire for conductor 0. Use one of the wires in the cable for this line. To determine which conductor it is at the voltmeter end, connect the positive voltmeter lead to any of the conductors and move the negative lead from one conductor to the other until you get the maximum up-scale deflection. This will occur when the negative lead is connected to conductor 0. You may then proceed to identify the other lines by the rapid procedure described previously.

Switch S was not included in the author's cable tracer-checker. The battery is simply removed when the instrument is not going to be used. The switch is a "plus" that eliminates this inconvenience, for those who wish it.

FLASH!! TELEMARINE NOW IN NEW 6-FLOOR BLDG. IN MANHATTAN!

SPECIALIZING IN COMMUNICATION BARGAINS

BOATING SEASON NOW HERE!!! 50 WATT, 6 CHANNEL RADIOTELEPHONE FOR BOATS OR FIXED STATIONS

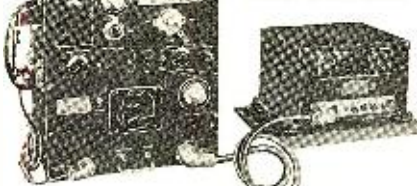

THE RADIOTELEPHONE BARGAIN all the Pleasure and Fishing Boats are talking about! This Transmitter-Receiver (BC-669, part of SCR-543) is beautifully and ruggedly built. Provides 6 fixed channels of crystal-controlled transmission and reception, in addition to manual tuning when desired for reception. Freq. range 1000 to 4500 KC. The BC-669 FCC currently accepted 2-3 mc marine band. With recommended 12 V. DC (or 24 V. DC dynamotor) power supply will deliver 50-60 watts output. Supplied with instruction book, connecting cable, power supply constructional data, all tubes, all tested and guaranteed. See our previous ads in 1957 Radio Telev. News for illustration and complete data, or send for descriptive bulletin!

50 W. RADIOTELEPHONE (BC-669 A, B, or C). USED-EXCELLENT as described above. Shpg. wt. 185 lbs. EACH . . . \$99.50
SAME AS ABOVE, NEW-UNUSED. EACH . . . \$139.50
12 V. DC POWER SUPPLY, for above. Has 2 Dynamotor, one for transmitter (340 V. at 4.30 ma.) and one for receiver. Produces 50/60 watts out-put. ALL wired and tested. EACH . . . \$89.50
COMPLETE 12 V. DC POWER SUPPLY KIT. Assemble and wire yourself. All material and diagram. \$45.00
PE-110, A, B, or C POWER SUPPLY, for 110 V. 60 cycles AC operation. LIKE NEW condition. EA. \$89.50
HANDSET FOR ABOVE with appropriate plug connector . . . \$14.50

SENSATIONAL BARGAIN!! TCS TRANSMITTERS, RECEIVERS, AND ACCESSORIES

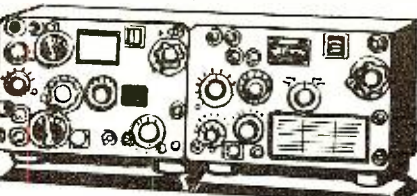

You've never seen TCS Transmitters and Receivers priced so low! This communications work horse of the Navy and Coast Guard never sold in surplus for less than \$3000 per set. Acc. cost over \$4000.00 per set. It's ideal for mobile or fixed station use; precise, trouble-free, and consistent. Excellent for Marine-Band (2-3 mc) and Mod. sections of transmitter, minimize drain. Transmitter and receiver certain front panel controls on applications. Includes certain diagrams furnished. To meet FCC requirements. It will even meet FCC requirements regarding second harmonic radiation, since the transmitter uses a Buffer stage, plus variable link coupling between the final RF Tank and a pi-network with coils to the antenna, all of which reduces harmonic radiation to absolute minimum. Other features of TCS Transmitters and Receivers are: *complete coverage 1.5 to 12.0 mc. all band-switching. *4-channels crystal-control, plus one channel manual tuning (in transmitter precision VFO). *uses 1625 instant heating filament tubes (equivalent to Type 807) in RF Amp and Mod. sections of transmitter. *minimize drain. *rated at 40 watts CW and 20 watts phone output when transmitter plate voltage is 425 V., but this power can be easily doubled by using 600 vdc plate supply. *Transmitter or Receiver designed to operate from either 12, 24, 110 V. DC or 110/220 V. AC power supply. Complete diagrams furnished. *Receiver is super-sensitive superhet, with excellent sensitivity & selectivity characteristics, and includes BFO circuit for CW reception. *mits precise and low error complete with tubes, good clean condition but untested. TCS-5 to 9) TRANSMITTER, with all tubes, schematic diagram and power supply diagrams, as outlined above. Shpg. wt. 60 lbs. . . . \$39.95

TCS-9 to 14) TRANSMITTER, same as above but has minor modifications which make these models more desirable. EACH RECEIVER, complete with tubes and schematic diagram, as described above. Shpg. wt. 50 lbs. EACH . . . \$59.95
TCS-5 to 14) RECEIVER, complete with tubes and schematic diagram, as described above. Shpg. wt. 50 lbs. EACH . . . \$57.50
12V. DC POWER PACK FOR TCS RECEIVER, D-521 operates from 12V., supplies 225V. DC at 100 ma. and 12.6V. DC for receiver filaments. Permits use of Receiver on boats, mobile, etc. Like-New, Guaranteed. Shpg. wt. 15 lbs. EACH . . . \$11.50
110V. AC PACK, to operate receiver, Type RA-20, supplies same voltages as above. Like-New, Tested. Shpg. wt. 15 lbs. EACH . . . \$15.00
TCS 12V. DC POWER SUPPLY, designed to supply necessary power to both transmitter and receiver, from 12V. AC power supply. Excellent condition, tested. Shpg. wt. 4 lbs. EACH . . . \$49.95
TCS REMOTE CONTROL. Contains loudspeaker with volume control for remote receiver monitoring, plus on-off switches for controlling power to Receiver or Transmitter, plus microphone and headset jacks. Dim: 6 3/4" L. x 3 1/4" H. x 3 1/2" D. All NEW units. Shpg. wt. 12 lbs. EACH . . . \$9.95
TCS ANTENNA LOADING COIL used with transmitter to obtain maximum output with short whip antenna. Contains tapped loading coil with 2-tap switch for various lengths of antenna. Dim: 6 1/2" H. x 1/2" W. x 6 3/4" D. Used-excellent cond. Shpg. wt. 7 lbs. EACH . . . \$6.95

All Above Material Subject to Prior Sale. 25% Minimum Deposit with All C.O.D.'s. Min. Order \$5.00. All Prices F.O.B. Our Address.

TELEMARINE —
COMMUNICATIONS CO., INC.
140 WEST B'WAY, NEW YORK 13, N. Y.
PHONE: Cortland 7-5444
Cable Address: Telemarine N. Y.

FM TRANSCEIVER 29-39 MC

Signal Corps BC-659, part of popular SCR-609 (410 V. Rectifier equip.). Combination Transmitter and Receiver for FM communications. 2-channels, both crystal-controlled. Transmitter use not recommended except for military or special applications, but receiver is ideal for monitoring 28.9 to 38.9 mc (range between 28.9 and 38.9 mc requires a few coil turns). Incorporates built-in loudspeaker, and construction is such to permit easy under dash mounting to permit complete access to front panel controls. Separate power supply required to provide 100 to 130 volts "B" supply, and 1.5 volts "A" supply. The PE-117 or 120, available separately, supplies these voltages from either a 6, 12 or 24 volt AC source, but this receiver or other supply can be easily adapted. Dim. of Transceiver 10 1/2" L. x 13" W. x 7 1/2" H. Supplied complete with all tubes and Instruction Sheets with Schematic Diagram. Shpg. wt. 50 lbs.
PRICE PER SET, . . . \$24.95
NEW-UNUSED. . . \$24.95
PE-117 or PE-120 Power Supply for above. . . \$24.50
Used-Good . . . \$24.50

NEW, WALKY-TALKY (BC-611) CHASSIS

Here's the chance to build your own real compact lightweight hand-held Walky-Talky! Designed to transmit and receive on one crystal-controlled frequency between 3.69 and 1.1 mc. The real Ham could revamp the coils for operation on higher frequency amateur phone bands. This will result in increased antenna power output and longer distance transmission. By building your own case for this chassis, with space for larger batteries and increased B voltage, further increased power and longer service from batteries will result. These chassis are NEW, unused, with telescoping antenna but less tubes, coils, or crystals. Tubes required: 1-1R5, 1-6X4, 1-6X5, 1-12A4, and 1-6X6 (all are plug-in coils required (sold separately), 1-Antenna, and 1-RF Tank. Battery voltages required for original "A" and "B" are 103.5 volts "B" battery, the latter may be increased to 135 or 167.5 volts to produce higher transmitter output. Supplied as specified with Schematic diagram. Shpg. wt. 6 lbs. \$8.95
EACH—Chassis only . . . \$8.95
PAIR OF COILS, for above, Ant. & RF Tank . . . \$1.25

ACCESSORIES FOR ABOVE

CAST ALUMINUM HOUSING, case for Above Walky-Talky, includes battery compartment, Push-Button Switch with rubber weatherproof cover, top and bottom covers. All items separate for home assembly. \$17.75
PRICE, as outlined.
ALUMINUM HOUSING ONLY, Less Top & Bottom Covers or push-to-talk switch. . . \$9.95
MICROPHONE OR RECEIVER ELEMENTS, with matching transmitter or bakelite enclosure. . . \$5.50
EITHER ELEMENT (New) . . . \$5.50
TEST UNIT 1-135. Contains Microphone and Receiver elements, Volt-Milliammeter, and Push-Button Switch circuit to thoroughly test above Walky-Talky. Parts can be used to help complete unit. Used-Excellent. Shpg. wt. 15 lbs. . . \$17.95
PRICE, EACH . . . \$17.95
PUSH-TO-TALK SWITCH, and Filament assembly for accurate motor, and receiver slide-switch chassis. Also includes separate rubber cover for inclosing and insulating proofing switch. Shipped Postpaid (add 10c if insurance desired). . . \$19.50
PER SET . . . \$19.50

LIMITED QUANTITY BARGAINS

FLASH!! READ THIS WIRE RECORDING MAGAZINE. Complete amateur magazine consisting of following interesting mechanism: 1 supply reel and 1 take-up reel with approx. 9000 ft. stainless steel wire, 0.04 dia. (at rated speed of 2 1/2 ft. per second will provide 1 hour recording and playback). Other assemblies include brake shoes, time indicator, lens, wire guide, and guide, reel bearings and sleeve, crumpling heads, recording-reproducer head, forward and reverse limit switches, winding bridge, wire guide, and 2 splayed reel shafts, latching studs, electrical contacts, etc. Wired, for 115 volt, 60 cycles AC, 85 watts, less shipping charges. Enclosed in finished, sturdy, portable enclosure with top front glass cover opening 4" L. x 3/4" W. and a scaled 60 minute dial, graduated in 10 minute divisions. Overall Dim: approx. 8 3/4" L. x 4 3/8" H. x 2 5/8" D. Model RB-100. See Feb. '58 NEW-UNUSED Units, does not include erasing oscillator (20-30 KC) or amplifier. Shpg. wt. 15 lbs. \$6.95
EACH . . . \$6.95
12 VOLT DC TO 120 V. AC ROTARY INVERTER FOR BOAT OR CAR. Output 3.1 amps, 60 cycles AC from any 12 volt car or boat battery. Permits using 110-120 volt AC appliances or equipment, such as refrigerator or TV, vacuum cleaners, etc. Horizontal type with carrying handle, approx. 12 1/2" long x 6 3/4" W. x 10 1/4" H. All NEW-UNUSED units. Shpg. wt. 7 1/2 lbs each. \$49.95
WHILE THEY LAST, EACH \$49.95
2-CHANNEL FM TRANSCEIVER, 30-33 MC. . . \$49.95
is an 18 miniature tube FM transmitter-receiver with final output of 1.5 watts. Range, under average conditions, 10 miles, when used near, land or fixed station. Incorporates vibrator-type power supply with output from either 6 or 12 V. DC. Both channels crystal-controlled. See Feb. '58 ad this magazine for full details. Shpg. wt. 45 lbs. Used, Excellent condition. \$34.95
PRICE, EACH, Not Tested. . . \$34.95
LAB MODEL FM SIGNAL GENERATOR, the 1-208 is a precision instrument worthy of the name. It provides service shop, or for production testing and alignment on mobile FM receivers. Freq. range, in 2 bands, 1.9 to 4.3 mc for 1-F alignment and 19.0 to 19.5 mc incorporates such fine features as Calibrated Microvoltage-Attenuator, Adjustable Sweep, RF vacuum Tube Voltmeter, Loudspeaker, Crystal Calibrator, and 1000 cycles per sec. (monies), etc. See Feb. '58 ad for illustration and full details. Operates from either 12 V. DC (internal dynamotor) or mobile field work (110 V. AC, 60 cycles for lab. use. Complete with tubes, crystal and instruction data. Shpg. wt. 17 1/2 lbs. \$69.95
PRICE, used-excellent, not tested. . . \$69.95
PRICE, NEW—tested. . . \$139.50
BC-791 CODE RECORDER. Consists of Amplifier and Recorder which signals on paper tape with ink writing stylus. Similar to McElroy Model RR-000 Recorder, 110 V. AC, less tape puller. Housed in oak case, all NEW Units. Shpg. wt. 40 lbs. \$14.95
EACH . . . \$14.95
6 or 12V. DC VIBRATOR POWER SUPPLY. Type PE-104, operates from either voltage and supplies completely filtered B and A voltages as follows: 1.5, 4, 10, and 100 vdc DC. Uses synchron. vibrator, no tubes. Ideal for mobile packs, transceivers, etc. Dim: 3 1/2" x 4 3/4" x 6 1/4". NEW UNITS. Shpg. wt. 12 lbs. EACH . . . \$9.95

MASTER THE SKILLS OF
MAGNETIC RECORDING

TECHNIQUES OF MAGNETIC RECORDING

by Joel Tall

Brings the many aspects of this exciting new medium into focus. Thorough descriptions of the various recording models, techniques, and practical uses in TV, radio, and film as well as in education, science, business, and law. Excellent chapter on recording nature sounds.
112 illus., 472 pp. \$7.95



FOR COMPLETE AND
BETTER SERVICE

MANDL'S TELEVISION SERVICING

New Revised Edition
by Matthew Mandl

This most popular of all books on practical TV servicing has just been brought completely up-to-date. Here you'll find practical instructions on UHF and VHF receivers; the principles and servicing of the new compatible color system; the function and servicing of transistors; the theory and servicing of printed circuits; principles of cascade tuners, automatically focused tubes and other devices. A unique Master Trouble Index enables you to diagnose and correct the defect immediately from any symptom.
308 illus., 442 pp. \$6.50

EVERYTHING YOU NEED TO
KNOW ABOUT CIRCUITS

HANDBOOK OF BASIC CIRCUITS: TV-FM-AM

by Matthew Mandl

A unique guide providing detailed description of the major circuits with block diagrams, function, and applications. Any specific circuit is easily located by reference to the complete title listing. Among the 136 systems covered: Horizontal-Sweep Output System, Push-Pull Audio Amplifier, Gated-Beam FM Limiter-Detector, Synchrolock A-F-C System, and 12 different Transistor Circuits. 161 illus., 359 pp. \$7.50



CASH IN ON A
GROWING MARKET

CLOSED-CIRCUIT and INDUSTRIAL TELEVISION

by Edward M. Noll

The technical aspects—transmission, reception, and equipment, as well as the present and potential applications in industry and business—of closed-circuit TV. Here in non-mathematical terms are the necessary theory and techniques to handle the special transmission systems, scanning processes, signals, generators, amplifier systems, and cameras used in closed-circuit television.
128 illus., 230 pp., paper-bound. \$4.95

THE MACMILLAN COMPANY
60 Fifth Avenue New York 11, N. Y.

Please send me the books checked below.
I enclose \$ _____

- | | |
|--|--|
| <input type="checkbox"/> Tall: TECHNIQUES OF MAGNETIC RECORDING \$7.95 | <input type="checkbox"/> Mandl: MANDL'S TELEVISION SERVICING \$6.50 |
| <input type="checkbox"/> Mandl: HANDBOOK OF BASIC CIRCUITS FM-TV-AM \$7.50 | <input type="checkbox"/> Noll: CLOSED-CIRCUIT AND INDUSTRIAL TELEVISION \$4.95 |

Name _____

Address _____

City _____ Zone _____ State _____

Service Industry

RADIO SERVICE
TV
SERVICE
News

IN OUR NEXT issue, we will feature the first in the projected series on service associations. The first group whose story will appear is MARTS—Milwaukee Association of Radio and Television Services. This active and successful group was one of the first respondents to our request for contact with associations. If you would like us to bring the story of your own organization to the attention of the industry, simply fill out the coupon on this page and return it to us right away. The questionnaire we send you will enable you to give us the facts without undue difficulty.

The recent annual Midwest Electronic Forum, sponsored by the Television Service Association of Michigan, brought together service-association officials from many states. Representatives from service groups located in Texas, Iowa, Minnesota, Illinois, Indiana, Ohio, and Pennsylvania attended the round-robin meeting that preceded the opening of the forum.

The mechanics of administering the Detroit service licensing law and its effectiveness in removing some of the questionable practices in the service activity in that area, were of top interest to the visiting association leaders. The consensus among the service dealers present was that more than seventy-five per-cent of the established service dealers in the industry are now in favor of licensing for service dealers and technicians in their states.

The opinion expressed by Albert M. Haas of Philadelphia typifies the changed thinking toward formal licensing on the part of many outstandingly successful service dealers. Owner of the *Haas Television Service* of Philadelphia and prominent in Philadelphia service-association activities, Mr. Haas was a highly vocal opponent of licensing in any form. He was one of the leaders in forming the Greater Philadelphia Council of Service Asso-

ciations which had as its objective the correction of service abuses through industry cooperation.

In discussing the subject, Mr. Haas said, "I am now convinced that licensing is the only way that the basic troubles of the service business can be corrected. Like the dealers in Detroit, we cooperated with our local law enforcement agencies in every possible way to eliminate the crooks and the incompetents from the business. But while we were giving freely of our time to get rid of one fast-dollar boy, two or three more were jumping into the business. Since there are no controls over the qualifications of men who get into this business, policing the service field under present laws is like trying to beat out a forest fire with a fly-swatter.

"I do think," continued Mr. Haas, "that the annual cost for a service dealer's license should be high enough to make his franchise to do business really worthwhile. If a service dealer had to pay one hundred dollars per year for his license, he would hesitate to jeopardize his franchise by engaging in questionable practices. Another thing, he would operate his shop on a business basis and get adequate charges for his labor and service calls. It would be a strong deterrent to the loading of charges for tubes and parts to make up for insufficient charges for labor or home service."

Members of the Television Service Association in Detroit have cooperated whole-heartedly with the license commission to make the ordinance successful. Where experience has shown that certain changes in the regulations were needed, such changes have been made by the commission. Since the ordinance served to eliminate the price advertising of service, it effectively closed that avenue of promotion for feeding suckers into fast-dollar operations.

Service Editor
RADIO & TV NEWS
1 Park Avenue
New York 16, New York

We want to tell you more about our association. Please send us your questionnaire.

Name of Association.....

Mailing Address.....

Name of President or Corresponding Sec'y.....

In refuting claims that service licensing will eliminate the small service shops and part-timers, members of the license commission point to the figures on the number of businesses licensed since the ordinance went into effect. At the time the license measure was passed, it is said there were 492 separate listings under radio and TV service in the classified section of the Detroit telephone directory. At the present time, almost 800 service shops have been licensed to do business in the city of Detroit.

Commission members say that, while some of this increase is due to the licensing of shops in adjoining communities to enable them legally to handle service work in Detroit, by far the greater percentage of the increase represents small shops and part-timers who restrict their servicing activities to their neighborhood areas. It was pointed out by one commission member that most part-timers work from their homes and do not subscribe to the conventional business-type telephone service. The licensing ordinance does not discriminate against such industry members, he said. The only requirement is that they must meet the standards set up by the commission and abide by its rules and regulations.

Plans are under way to change the name of the Detroit association to the Television Service Association of Detroit so the former name, TSA of Michigan, can be used to designate the

Michigan State Federation of Service Associations.

California

A study of the fee pricing system adopted by the members of the Radio-TV Association of Santa Clara Valley reflects the trend in the service industry to lift service and labor charges to a level commensurate with the costs of doing business.

Reporting on the new system of pricing, which is based upon fixed fees rather than on parts plus labor, Chet Spink, dynamic editor of the RTA Magazine, pointed out that, where the first suggested price list—issued in July 1956—recommended home service call charges of five dollars, the new schedule figures home service call charges at \$6.25. The hourly bench rate on the first schedule was \$5.00. Bench time, now described as TV shop fee, is figured at seven dollars per hour on the current schedule.

North Carolina

A lively, new service-association house organ recently made its debut in North Carolina. Titled the "E. T. A. Bulletin," it is published monthly by the members of the Electronic Technicians Association, Inc., P. O. Box 5193, Winston-Salem, N. C.

Reporting on efforts to encourage the formation of more local associations leading to the creation of a
(Continued on page 140)

TAPES

YOU CAN TRUST!



Enjoy professional quality at popular price!



Magnetic Tape

THE TERM "SCOTCH" IS A REGISTERED TRADEMARK OF 3M CO., ST. PAUL 5, MINN. EXPORT 99 PARK AVE., N.Y. CANADA: LONDON, ONT. © 3M CO., 1956.

MINNESOTA MINING AND MANUFACTURING COMPANY  ...WHERE RESEARCH IS THE KEY TO TOMORROW

DX-16 Super Deluxe TV KIT 70° or 90°—operating all 17", 21", 24" and 27" PICTURE TUBES

NEW IN DESIGN—Mounts Horizontally, Vertically or Sideways.

- ★ Produces a Superior 16-Tube Chassis with 30-Tube performance.
- ★ Latest advanced Intercarrier Circuitry and Multi-section Tubes.
- ★ Standard Cascode Tuner for Selectivity and Fine Definition.
- ★ 5 Microvolts Video Sensitivity (20 volts peak to peak at CRT grid).
- ★ Fast Action AGC for Drift Free, Steady and Clear Pictures.
- ★ 3 Hi-gain Video I.F. Stages for excellent Contrast and Details.
- ★ AGC Level and Area Control, for adjusting reception to signal area.
- ★ All Video and I.F. Coils factory pre-aligned and tuned.
- ★ Horizontal Sweep Circuit is the famous RCA Synchronuide Network.
- ★ Large 250 ma Power Transformer—not a hot chassis.
- ★ Large 12" Concert-tone Speaker.

LIFE-SIZE step-by-step Building Instructions

\$79.97

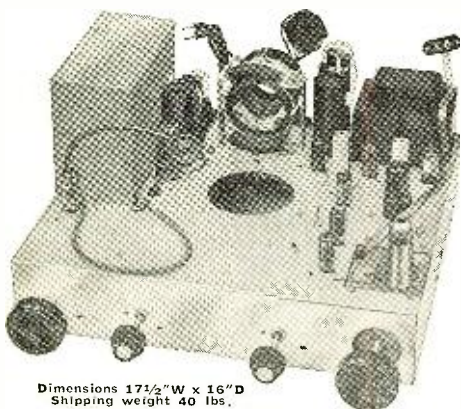

Dimensions 17 1/2" W x 16" D
Shipping weight 40 lbs.

COMPLETE KIT WITH SET OF WESTINGHOUSE TUBES

4—6CB6 and 6U8, 6T8, 6C4, 12BH7, 6SN7, 6BQ6, 6W4, 1X2B, 5U4, 6J6 and 6BQ7 included in the Tuner, (less CRT).....

BUILD YOUR OWN TV CABINET FOR ANY TV CHASSIS

Comparable to the type that Top Mfrs. use on their higher priced TV sets.

CABINET KIT with 90% of the job done, includes—

- **FRONT SECTION** complete as pictured in Solid Mahogany, Walnut or Blond Korina.
 - **TOP, SIDES, BACK** with CRT CUP, MASK, SAFETY GLASS, ETC. and Easy-to-follow Instructions.
- Front, Top and Sides supplied in a beautiful Piano Finish ● ● ● Knob panel undrilled (or drilled on receipt of your template ● ● ● For matching Mask specify type or CRT used. Same price for Mahogany, Walnut or Blond.

Worth \$60 when completed, only takes a few hours to assemble

21" CABINET KIT 26"H, 25"W, 22"D **\$24.95**

(Also available for any smaller size CRT)

Worth \$85 when completed, only takes a few hours to assemble

24" or 27" CABINET KIT 30"H, 28 1/2"W, 22"D **\$36.47**

Maximum Shipping weight 48 Lbs.

FRONT SECTION for WALL INSTALLATIONS Includes Mask, 21" ...\$17.45 | 24" or 27" ...\$22.97

Same price on Mahogany, Walnut or Blond or in Natural (unfinished) for your own color application.



BROOKS RADIO & TV CORP., 84 Vesey St., Dept. B, New York 7, N.Y.

**Interesting, Pictorial
FREE
BOOKLET**

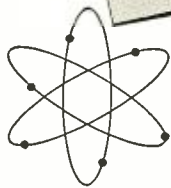

to help
you
decide on

**YOUR CAREER
IN ELECTRONICS
RADIO-TV
COMPUTERS**

Here is a graphic story about dynamic careers for engineers and engineering technicians. Booklet covers such subjects as:

- Wide variety of job opportunities.
- The courses offered, degrees you can earn, and what you are qualified to do.
- Pictures of the Milwaukee School of Engineering, its facilities, plus Milwaukee scenes.
- Recreation, student organizations, fraternities.
- Scholarships, part-time work, admission requirements.

— and many other important and interesting facts to help you understand and decide on your career in engineering. Send for your free copy today — no obligation whatsoever.

MS-82

Milwaukee School of Engineering
—dedicated to serving young men and industry

SEND COUPON

**Milwaukee School
of Engineering**
Dept. RT-558, 1025 N. Milwaukee St.
Milwaukee, Wisconsin

Please send me free the new booklet
"Prepare for Your Career in Engineering"
I'm interested in.....
(name of course)

Name..... Age.....

Address.....

City..... Zone..... State.....

I'm eligible for veteran's education benefit
Yes No Discharge date.....

state-wide organization, editor David T. Drage said:

"During the past month Clifton Lynch, Clive Pardew, and myself attended a meeting of the Radio and Television Service Dealers Association of Durham. A number of shop owners from surrounding towns were invited and attended. The main purpose of the meeting was to stir up interest to form associations in the nearby cities. Mr. Charles Womack gave a very interesting talk on planning for profits. He had the cost of doing business for shops in Virginia and North Carolina, which he compared with six shops in Durham.

"To finish the evening, I gave one of my pep talks on service charges and the need for an association. The next regular meeting of the Durham association will be held in Raleigh to help form an association there."

Texas

Members of the San Antonio Radio and Television Association re-elected C. W. Schertz of the *Lone Star TV Center*, to serve as president for the coming year.

Other officers elected at the regular annual meeting included O. O. Brigman, *Brigman Radio & TV*, vice-president; Don Van Der Brugen of *Sight & Sound of San Antonio*, secretary; and Tom Boyd of *Boyd's Radio & TV Service*, as treasurer.

Ralph McCoy of *City-Wide TV Service* and Roland Mueller, *M. & M. TV Service*, were elected directors to serve for the current year.

The 1958 aims of the association include state licensing for service dealers, expanded training programs sponsored by the association, group insurance and accounting, and the spreading of information to the public pertaining to member functions.

A method used to transmit two TV programs on a single channel is being demonstrated here by means of the Blonder-Tongue Bi-Tran system. The method was proposed to the FCC some months ago (see December, 1957 issue). The system would enable each TV channel to transmit "A" and "B" programs. The "A" signal would consist of standard commercial programs as now provided and viewed on any TV set. The "B" signal would be assigned to those who seek to use existing television facilities and time. The "B" picture could be received privately, but only if the TV set were equipped for optional viewing by means of the small adapter shown on table with TV set at left.



The San Antonio association is an affiliate of the state-wide Texas Electronic Association. —30—

ST. LOUIS ELECTRONICS CLUB

THE Electronics Club, organized by electronics manufacturers, manufacturers' salesmen, reps, and distributors in the St. Louis area, has been established in a luxurious suite at the Congress Hotel in St. Louis.

The club facilities consist of three dining areas, a lounge, conference room, butler's pantry, and bar.

Located on the 17th floor of the hotel, the club's membership will be limited to 60 firms. Any member may have use of the two private dining rooms for meetings, dinners, luncheons, etc. as well as use of the Conference Room without charge.

Officers of the Club are Norman W. Kathrinus, president; Herb Knaggs, vice-president; Tom Brown, secretary; and Mike Ebinger, treasurer. —30—

UNIQUE HI-FI CONTEST

THORENS Company, New Hyde Park, N. Y. has come up with a unique hi-fi contest whose pay-off covers a period of ten years.

Contestants are asked to name their favorite hi-fi salesman and tell why in 50 words or less.

The first year's prize is a Thorens TD-124 precision transcription turntable plus, for nine more years, one new Thorens high-fidelity component every year.

The "favorite salesman" will get \$50.00 in cash and his boss will receive a like amount.

Judges of the contest will be a panel of editors of leading hi-fi publications. The winner of the contest will be announced in June.

Official rules and entry blanks are obtainable at hi-fi component dealers or from the company's current advertisements. —30—

INFRARED SNIPERSCOPE TELESCOPE & PARTS

See in the dark—without being observed. War surplus Sniperscope M-2. Gov't cost about \$1200. Used for industrial plant security; research lab experiments; infrared photography; spectroscopy, etc. Instrument complete, ready to use. Includes Power Pack, infrared light source. Will operate from 6 V auto battery. Battery or transformer available.



Stock No. 85,053-DU . . . Shipping **\$150.00**
weight approx. 12 lbs. f.o.b. Barrington, N. J.

Order by stock No.—Send check or M.O.—money-back guarantee!

Save still more money! Build your own Sniperscope! We will furnish instructions—parts, including: Power Packs, 1P25A image tubes, light units, filters, etc. For details—request FREE Catalog "DU."

SPECIAL! INFRARED 1P25A IMAGE TUBE
Stock No. 70,127-DU \$9.95 pstpd.
Order by stock No.—Send check or M.O.—money-back guarantee!

COLOR TV TUBESCOPE
Saves time, effort in alignment of color dot pattern.
Stock No. 50,139-DU \$24.50 pstpd.
Order by stock No.—Send check or M.O.—money-back guarantee!

GET FREE CATALOG "DU"
America's No. 1 source of supply for experimenters, hobbyists. World's largest variety of Optical Items. Bargains galore. . . . War Surplus—Imported—Domestic! Microscopes, Telescopes, Satellitescopes, Color TV Tubes, Infrared sniperscopes and Parts, Prisms, Lenses, Reticles, Mirrors and dozens of other hard-to-get Optical Items.

WRITE FOR FREE CATALOG DU
EDMUND SCIENTIFIC CO.
BARRINGTON, NEW JERSEY

repairing TV sets?
for the right part to do
the best job

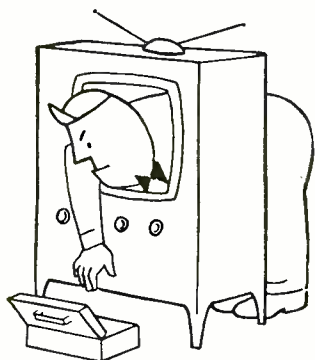

you'll find it
faster in the

MASTER

new 1958 edition—world's largest
electronic catalog only **\$3.50** at
your local parts distributor—now

Free! Write for Panel Lamp Chart.

THE RADIO-ELECTRONIC MASTER
60 MADISON AVE., HEMPSTEAD, N. Y.

Electronic "Accordion"

(Continued from page 55)

able resistor in place of one of the fixed resistors (such as R_1), closing the corresponding "key" (S_1) and comparing the signal produced with that obtained from a standard tuning fork or by sounding the desired note on a piano or other musical instrument. The adjustable resistor's value is then changed until the electronic "accordion" produces the desired note. The resistor's value is determined and a fixed resistor of the same value is installed.

A standard decade box or a calibrated potentiometer may be used when making these tests to determine the exact resistor values needed. A friend with a musically trained ear is a great aid when comparing the notes produced by the electronic "accordion" to the standard notes obtained from a conventional instrument.

In general, the resistors needed will have an "odd" value, that is, their values will fall between standard EIA (RETMA) values. The *exact* value needed is obtained by using either parallel or series combinations of resistors. For example, a 27-ohm resistor shunted by a 160-ohm resistor gives slightly over 23 ohms. Thus, each of the resistors shown in the schematic diagram (R_1 to R_{12}) in the base bias circuit will usually consist of two (or more) individual resistors.

The values of capacitors C_1 to C_3 are determined in a similar manner. Typical values will fall between 0.1 and 2.0 μ fd. In general, each capacitor value will be chosen to modify the note produced as a given "key" is depressed so as to sound "sharps" and "flats" instead of sounding a completely new note. Some builders may prefer to use arbitrary values for the capacitors, using these components simply for specialized sound effects rather than for playing tunes.

Operation and Use

After the wiring is completed and checked and proper resistor and capacitor values have been selected and installed, a back cover can be added and the instrument is "ready for use."

The electronic "accordion" is held between the two hands, much like a conventional accordion. The fingers of the right hand are used to sound individual notes (by depressing the appropriate "key" switch), while the fingers of the left hand are used for switching the instrument's volume (by opening or closing S_{16} and S_{17}) or for introducing special sound effects by depressing the capacitor push-button switches (S_{13} to S_{15}). The power switch (S_{18}) is left closed all the time the instrument is being used. It is not necessary to switch the instrument "off" between musical selections, for example, since the steady current drain when no note is being sounded is very small.

\$
Only 00

REPLACEMENT CONTROL DATA
FOR 18,000 TV SET MODELS!

HOWARD W. SAMS "REPLACEMENT GUIDE FOR TV CONTROLS"



A SAMS FIRST!

Lists recommended replacement TV controls of these manufacturers:

**CENTRALAB
CLAROSTAT
IRC
MALLORY**

NOTHING ELSE LIKE IT!

- The most complete replacement guide for TV Controls ever published—replacements for 18,000 TV models—covers virtually every TV set produced from 1947 to 1958!
- Every replacement control is *currently available* and recommended by the manufacturer to meet "Industry Part Number" specifications!
- Exclusive "Industry Part Number" system gives you quick, easy selection of all four manufacturers' recommended replacements!
- "Industry Part Number" listing helps you maintain inventory of most-needed controls for your service work—avoids needless duplication!
- Saves you time in selecting proper replacement controls—saves ordering time too. Guide actually pays for itself the first time you use it on a control repair job!



QUICK AND EASY!

Exclusive new "Industry Part Number" System locates recommended control replacements in just seconds.

A "MUST" IF YOU SERVICE TV!

8½ x 11"
BELONGS ON
YOUR BENCH

\$
Only 1.00

ORDER TODAY FROM YOUR SAMS
DISTRIBUTOR OR MAIL COUPON

HOWARD W. SAMS & CO., INC.

Order from your Sams Distributor today, or
mail to Howard W. Sams & Co., Inc., Dept. 1-E8
2201 E. 46th St., Indianapolis 5, Indiana

Send copy(ies) of "Replacement Guide for TV Controls." My (check) (money order) for \$ is enclosed.

Name

Address

City Zone State

(outside U.S.A. priced slightly higher)



FROM TRIAD

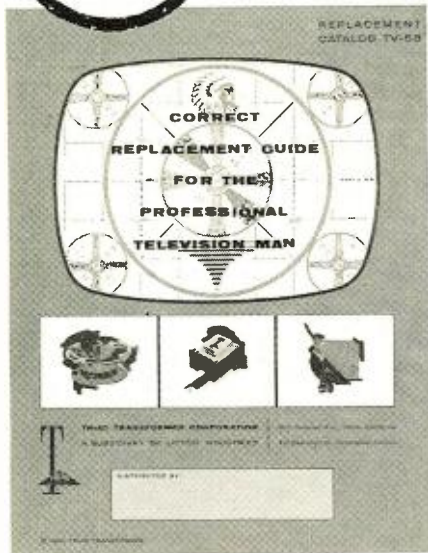

NEW REPLACEMENT CATALOG & TELEVISION GUIDE NOW AVAILABLE

The new TV-58 catalog & guide lists all of Triad's new replacement transformers...lists thousands of recommendations for television receivers...lists hundreds of recommendations not previously covered.

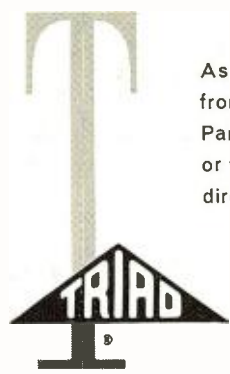

Ask for your copy from your Triad Parts Distributor— or write to us direct—

TRIAD TRANSFORMER CORPORATION
4055 REDWOOD AVE. | 812 E. STATE STREET
VENICE, CALIFORNIA | HUNTINGTON, INDIANA

A SUBSIDIARY OF LITTON INDUSTRIES



An enna News

"TNT TORQUE TV TENNA"
Snyder Mfg. Co. is now in mass production on its new "TNT Torque

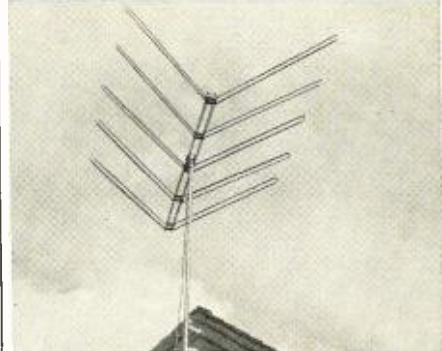

TV Tenna" a unit designed for roof installation and providing ultra-fringe reception without bulk.

The antenna is made with all-live aluminum elements and is minus the complications of phasing bars and extra harness. The design features the company's patented "Torque" system which furnishes a half wave-length span acting as a full wave-length and with full-wave reception.

The antenna is available in three models with three, five, and seven elements. The three-element unit is for metropolitan area reception, the five is for fringe areas, while the seven-element model will handle ultra-fringe reception.

For full details on this pre-assembled unit, write the manufacturer direct at Philadelphia.

TWO FM ANTENNAS

Winegard Company of Burlington, Ia. has recently introduced two gold

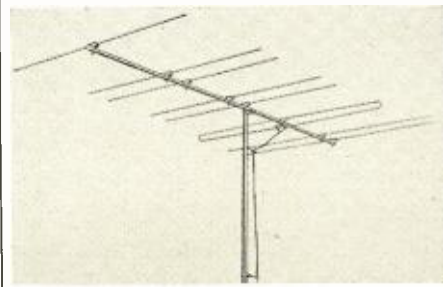

anodized FM antennas which have been especially engineered to provide maximum pickup for hi-fi tuners.

The Model FM3A consists of the antenna, mast, universal roof mount, fasteners, lead-in wire and set clip. It is non-directional and comes pre-assembled. It can be used in urban, suburban, and near fringe locations.

The second unit, the Model FMY8, is a high-gain, 8-element yagi. It has flat frequency response across the entire

FM band, with 10.2 db gain. It has been designed for fringe areas and long distance reception.

Write the manufacturer direct for full details and prices.

MICROWAVE ATTENUATORS

Antenna & Radome Research Associates, One Bond St., Westbury, N. Y. is now in production on a new series of microwave attenuators which feature a 3:1 bandwidth and high continuously variable attenuation with minimum insertion loss and low v.s.w.r.

The new ARRA units are five inches in diameter and cover the bands of .8 to 2.5 kilomegacycles and 2 to 6 kilomegacycles. The minimum insertion loss is .2 db and full insertion loss is at least 30 db over the full band.

These attenuators are applicable in all systems where variable radio-frequency attenuation is required. In ad-



dition, high resetability and accurate calibration make them suitable as laboratory instruments wherever accurate calibrated r.f. attenuators are required. For further details, write the manufacturer direct.

RMS "WAVEBOOSTER" ANTENNAS

Radio Merchandise Sales, Inc., 2016 Bronxdale Ave., New York 62, N. Y. has recently introduced the "Wavebooster" Series 1000 antenna line to the trade.

The new antennas utilize maximum weather-resistant construction and low silhouette design to reduce wind drag and stress. The folded dipole elements are double locked in high impact styrene plastic insulators to prevent element breakage resulting from the stress of icing and severe wind.

The company's "Quadro-Grip" U-bolt assembly grips the antenna cross-arm to the mast four times, preventing turning and slipping of the antenna on the mast. The new series is currently available in six models. Write the manufacturer direct for full details. —50—

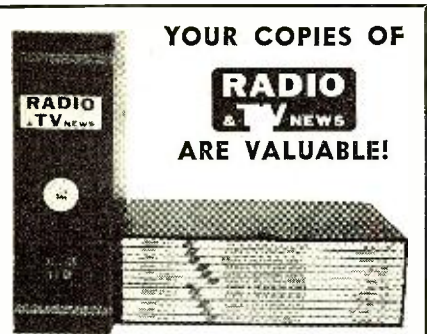

YOUR COPIES OF

RADIO & TV NEWS
ARE VALUABLE!

Keep them neat . . .
clean . . . ready for
instant reference!

Now you can keep a year's copies of RADIO & TV NEWS in a rich-looking leatherette file that makes it easy to locate any issue for ready reference.

Specially designed for RADIO & TV NEWS, this handy file—with its distinctive, washable Kivar cover and 16-carat gold leaf lettering—not only looks good but keeps every issue neat, clean and orderly.

So don't risk tearing and soiling your copies of RADIO & TV NEWS—always a ready source of valuable information. Order several of these RADIO & TV NEWS volume files today. They are \$2.50 each, postpaid—3 for \$7.00, or 6 for \$13.00. Satisfaction guaranteed, or your money back.

Order direct from:

JESSE JONES BOX CORP.

Dept. RN

Box 5120, Philadelphia 41, Pa.

(Established 1843)

MOVING?

BE SURE RADIO & TV NEWS
FOLLOWS YOU. PLEASE
SEND YOUR CHANGE
OF ADDRESS TO

RADIO & TV NEWS

Circulation Department

64 E. LAKE ST. CHICAGO 1, ILL.

MINIATURE TRANSFORMER
can be used as MMK Transformer
TRANSISTOR Transformer
3.5B Transformer

98¢ EA • 3 FOR \$2.75
100 FOR \$75.00. GOVT. COST \$14.00 EACH

GOVT. SURPLUS
JAN PORTABLE BATTERY TUBE
1U4 Mfg. by R.C.A.
TUNO-SOL, PENNSYLVANIA

EACH ONE IND. BOXED BRAND NEW
3 FOR \$100 • SEALED BOX OF 200 \$50.00
DEALERS INQUIRIES INVITED

RADIO RECEIVER
BC-652-A 2 to 6 m.c.—two bands
8 tube super heterodyne receiver
designed for A.M. or C.W.
3 tube crystal frequency calibrator
in receiver in separate chassis.
C.F.C.—calibrates receiver, cali-
brates trans. oscill. stage on
tunable freq. and presets freq.
Contains DM-40 Dyn. operat-
ing on 12 volts D.C. input. **\$29.95**

TERMS: 25% deposit with order, balance C.O.D.
All merchandise guaranteed F.O.B. Buffalo, N. Y.

SPARKS RADIO SUPPLY
194 GENESEE ST., BUFFALO 3, N.Y.

Service Business Budgets

(Continued from page 56)

dollars income from the sale of time and labor. It had \$2000 income from the sale of tubes, parts, and the like. However, at least 60% of this \$2000 must be paid out to suppliers for the materials sold. In other words, out of that two thousand dollars, \$1200 must be paid to suppliers, leaving a gross profit of \$800 for use in the business.

"This gives us an operating income of \$1000 from the sale of labor and \$800 from the sale of parts—a total of \$1800. Our operating costs are \$1500. This leaves an average gross profit, theoretically, of \$300 per month to use for ourselves or to expand the business.

"On an average in relation to the gross income of our businesses, we have six normal, three abnormal and three subnormal months. We are inclined to overspend during the abnormal months and fail to set aside the reserves we will need to tide us over the subnormal months. When your fixed operating expenses are fifteen hundred a month and your gross income is only twelve hundred, you are hard-pressed for money to pay your everyday bills. You don't have any money to pay on old accounts.

"That is why I feel that a business operating budget based on a realistically estimated annual volume is a must for every service dealer."

In the course of this discussion, another dealer pointed out that many shop owners commit themselves for telephone directory listing expenses that are completely out of line with the volume of business they are doing.

"Constant promotion is a must in the TV service business," he said. "A dealer must budget about five per-cent of his gross income from his service activities to maintain a normal volume of business. But this five per-cent must be used wisely.

"One dealer who recently folded up was spending about seventy-five dollars a month for phone directory listings. That amounted to about six per-cent of his total annual volume. He had no money available for any aggressive, more personalized promotions. His business just dried up.

"If that dealer had been operating on a budget he would have limited his directory listings to about twenty or twenty-five dollars a month. He would have used the rest in direct mail or other business-building types of promotion. If he had done that he would still be in business."

Every service business has its own pattern. This pattern can be determined by an analysis of gross income by months over a three to four year period. These figures can be used as an accurate measurement in anticipating income for the planning of a budget. Those are the information tools and the type of planning that help a business to grow.

BUILD 16 RADIO CIRCUITS AT HOME

with the New DELUXE 1958 Progressive Radio "Edu-Kit" only \$22.95

A COMPLETE HOME RADIO COURSE

NOW ALSO INCLUDES:
• TRANSMITTER
• SIGNAL TRACER
• SIGNAL INJECTOR
• CODE OSCILLATOR

- No Knowledge of Radio Necessary
- No Additional Parts or Tools Needed
- Excellent Background For TV

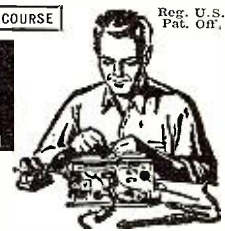

Reg. U.S. Pat. Off.

FREE Set of Tools, Pliers-Cutters, Tester, Soldering Iron, Alignment Tool, Wrench Set.

WHAT THE "EDU-KIT" OFFERS YOU

The 1958 "Edu-Kit" offers you an outstanding PRACTICAL HOME RADIO COURSE at a rock-bottom price. You will learn radio theory, construction and servicing. You will learn how to build radios using regular Schematics; how to solder and wire in a professional manner; how to service radio-troubleshoot radios. You will learn how to work with potted metal chassis as well as the new Printed Circuit chassis. You will learn the principles of RF and AF amplifiers and oscillators, detectors, rectifiers, test equipment. You will learn and practice code, using the Progressive Code Oscillator. You will build 16 Receiver, Transmitter, Code Oscillator, Signal Tracer and Signal Injector circuits, and learn how to operate them. You will receive an excellent background for TV. In brief, you will receive a basic education in Electronics and Radio, worth many times the small price you pay, only \$22.95 complete.

PROGRESSIVE TEACHING METHOD

The Progressive Radio "Edu-Kit" is the foremost educational radio kit in the world, and is universally accepted as the standard in the field of electronics training. The "Edu-Kit" uses the modern educational principle of "Learn by Doing." You begin by building a simple radio. Gradually, in a progressive manner, and at your own rate, you construct more advanced multi-tube radio circuits. You learn more advanced theory and techniques, and do work like a professional radio technician. These circuits operate on regular AC or DC house current.

THE KIT FOR EVERYONE

You do not need the slightest background in radio or science. The "Edu-Kit" is used by young and old, schools and clubs, by Armed Forces Personnel and Veterans Administration for training and rehabilitation.

One of the most important aspects of the "Edu-Kit" is the Consultation Service which we provide. We welcome students to send us their problems, whether related to any of the material covered in the "Edu-Kit" course, or encountered in other experiences in the field of electronics.

THE "EDU-KIT" IS COMPLETE

You will receive all parts and instructions necessary to build 16 different radio and electronic circuits, each guaranteed to operate. Our kits contain tubes, tube sockets, variable, electrolytic, mica, ceramic and paper dielectric condensers, resistors, tie strips, coils, hardware, tubing, punched metal chassis, Instruction Manuals, hook-up wire, solder, etc. In addition, you receive Printed Circuit materials, including Printed Circuit Chassis, special tube sockets, hardware and fasteners. You also receive a useful set of tools, pliers-cutters, an alignment tool, professional electric soldering iron, wrench set, and a self-powered, dynamic Radio and Electronics Tester. The "Edu-Kit" also includes Code instructions and the Progressive Code Oscillator. You will also receive lessons for servicing with the Progressive Signal Tracer and the Progressive Signal Injector, a High Fidelity Guide, FCC Amateur License Training Book, and a Quiz Book. All parts, components, etc., of the "Edu-Kit" are 100% unconditionally guaranteed, brand new, carefully selected, tested and matched. Everything is yours to keep. The complete price of this practical home Radio and Electronics course is only \$22.95.

TROUBLE-SHOOTING LESSONS

You will learn to trouble-shoot and service radios, using the professional Signal Tracer, the unique Signal Injector, and the dynamic Radio and Electronics Tester. Our Consultation Service will help you with any technical problems.

J. Stasaitis, of 25 Poplar Pl., Waterbury, Conn., writes: "I have repaired several sets for my friends, and made money. The "Edu-Kit" paid for itself. I was ready to spend \$240 for a course, but I found your ad and sent for your kit."

FREE EXTRAS

- Set of Tools • Radio Book • Radio and Electronics Tester • Electric Soldering Iron • Pliers-Cutters • Alignment Tool • Tester Instruction Book • Hi-Fi Book • TV Book • Quiz Book • Membership in Radio-TV Club • Consultation Service • FCC Amateur License Training • Printed Circuitry • Code • Merit Card • Valuable Discount Card • Wrench Set

UNCONDITIONAL MONEY-BACK GUARANTEE.

ORDER FROM AD—RECEIVE FREE BONUS
RESISTOR AND CONDENSER KITS WORTH \$7.00

- "Edu-Kit" Postpaid. Enclosed full payment of \$22.95
- "Edu-Kit" C.O.D. I will pay \$22.95 plus postage.
- Send me FREE additional information describing "Edu-Kit." Also send FREE Radio, TV and Hi-Fi Books worth \$1.50. No obligation.

Name

Address

PROGRESSIVE "EDU-KITS" INC.
497 Union Ave., Dept. 77E, Brooklyn 11, N. Y.

TREMENDOUS MOBILE VALUE!



FM MOBILE EQUIPT.—TYPE FMTR FOR 6 VOLT OPERATION

Complete system including Transmitter, Receiver, Power Supply, Cables, Control Head, Handset. Removed from Police cars in working condition. **\$99.50**
Terrific saving.
Crystals & Antenna avail.—price on request. PMC Kits & 12 V. Conversion Kits avail. from manufacturer. Write for further particulars or see April Radio News ad.

FM RADIO EQUIPMENT TYPE 2210 6-VOLT OPERATION

Designed for 2-way communication in mobile radio systems operating in the 152-162 mc very-high-freq. band. In most cases it will be used in mobile units and derive its power from the 6-volt vehicular electrical system. Write for detailed description. Complete with all accessories & instruction manual, ready for operation. Used, checked out. **\$129.50**
Crystals, 12-volt Conversion Kit & Antennas avail.—prices on request.

FM RADIO EQUIPMENT TYPE 2365 6-VOLT OPERATION

Designed for 2-way communication in mobile radio systems operating in the 25-50 mc very-high-freq. band. In most cases it will be used in mobile units and derive its power from the 6-volt vehicular electrical system. Write for detailed description. Complete with all accessories & instruction manual, ready for operation. Used, checked out. **\$99.50**
Crystals, 12-volt Conversion Kit & Antennas avail.—prices on request.

7 TUBE FM TRANSMITTER

• 6 Volt Dynamo Power Supply.
• Instructions for connecting and for converting to 10 or 6 meters.
A 7C7 is used in a resistance coupled crystal controlled oscillator circuit. The output freq. is between 30 & 40 MC. The crystal freq. is between 937.5 KC and 1250 KC. Two 7A8's are used as balanced modulators. Two 7C7's are used as freq. quadruplers, and a 7C5 as a freq. doubler. An 807 is used as a power amplifier. Also included is a schematic diagram of the transmitter, a hook-up diagram and instructions for converting to 6 or 10 meters. Transmitter housed in louvered grey enamel case 8"x8"x16" W. Link Radio Mobile FM Transmitter Model 35-UMF as described. **\$39.95**
Reg. \$325.00

SENSATIONAL SALE! ARC-5/R-28 2 METER RECEIVER

Excellent Condition **17.95**
T-18/ARC-5 TRANS. 2.1 to 3 mc. new \$19.95
T-23/ARC-5 TRANS. 100 to 156 mc, good used. \$13.95

COMMAND EQUIPMENT

BC-454 Receiver, 3-6 mc, good used. \$8.29
BC-456 Modulator, new. \$1.95
BC-458 Trans. 3-3 mc to 7 mc, good used. \$5.75
BC-696 Trans., 3-4 mc, good used. \$6.95
BC-602 Control head for SCR-522, new. \$1.29
Plugs for above Command Sets, PL-152 or PL-156-A \$0.55

HEADSETS

HS-23 high impedance, brand new. \$4.55
HS-33 low impedance, brand new with cord and PL-54 plug. \$4.65

BC-221 Frequency Meter

Real Value! QUANTITY IS LIMITED—so first come, first served. They are just like new, with original calibration charts. Range 125-20,000 KC with crystal check points in all ranges. Complete with crystal and tubes. **\$139.50**
MODULATED TYPE \$169.50
MODULATED TYPE with AC Power Supply 189.50
These Frequency Meters are factory tested, checked for frequency alignment and **GUARANTEED.**

SPECIAL! 20 LBS. of ASSORTED RADIO PARTS

A terrific buy at only **\$2.79**

Kit of 20 assorted RESISTORS, ranging from 10 to 100 watts, standard makes. **\$1.39**

Immediate delivery. Include 25% deposit with order—balance C.O.D. 50c handling charge on all orders under \$5.00. All shipments F.O.B. our warehouse, N.Y.C.

PLATT ELECTRONICS CORP.
20 MURRAY ST., NEW YORK 7, N. Y.
Telephone: COrtlandt 7-2575

Closed-Circuit TV (Continued from page 38)

system. Space forbids further descriptions of current applications of CCTV, but it should be noted that CCTV is performing also in the fields of advertising, production, and communication, sales meetings, bringing events to overflow audiences, military training and maneuver observation, and even in fund raising.

CCTV Sales and Costs

The various components of a CCTV system—cameras, lenses, control units, video monitors, accessories, booster amplifiers, broadband amplifiers, etc.—are available separately from most manufacturers. In general, however, a potential user of CCTV will do well to consider his equipment needs as a whole. This is best done in cooperation with the manufacturer of the CCTV equipment he intends to install. Some firms, for instance, maintain a no-charge sales engineering staff which surveys the user's needs, engineers the CCTV chain required to meet those needs, submits a system parts list, detailed drawings, and a complete cost estimate. Often the sales engineer is able to suggest a more efficient or economical system than the user had originally envisioned.

Costs vary as greatly as the range of complexity of CCTV systems. It is possible to purchase and install a complete basic CCTV chain for under \$2000. Large, elaborate systems have cost as high as \$250,000. But every user who has observed the remarkable resources of his CCTV system agrees that its initial cost has been repaid easily in money or in less tangible, but equally real, values.

R.F. Versus Video

There are two ways of distributing picture information for wired transmission. One method is to use a strictly video system in which the dis-

tributed signal is at video frequency (0 to 6 megacycles) for reception by studio-type video monitors. The second and more widely used system is the r.f. method, where the distributed signal output is a video modulated v.h.f. channel which can be received on a conventional TV set. Most CCTV camera units supply both r.f. and video outputs simultaneously.

The appropriate method for any application is determined by the degree of resolution (ability to reproduce fine detail) that is required, as well as by the factor of cost. A video system affords horizontal resolution of 600 lines across the monitor screen. This high rate is made possible by the video monitor, which requires no r.f. tuner and is available with a bandwidth as high as 10 megacycles. Certain other characteristics of the video monitor also make for superior picture quality. However, since the cost of a video monitor is usually higher than that of a conventional TV receiver, the video system is used mostly for installations, such as the one at the Los Angeles Water and Power Supply Steam Plant described previously, where maximum detail is of utmost importance. An r.f. system, on the other hand, is capable of 350- to 400-line resolution, which is broadcast studio quality and acceptable for most applications. The lower resolution of the r.f. system is a result of the narrower bandwidth of conventional TV receivers. The reduced cost and somewhat greater flexibility of this system were the reasons for its choice in the St. Mary's Hospital installation mentioned earlier.

In a typical basic video system, the camera signal feeds the control generator which contains synchronization, sweep and video circuits, and controls. A plug-in video amplifier boosts video output at the control generator output jack by 6 db to a 1 volt level. Connected by RG-11/U cable to a video monitor 200 feet distant, the signal level at the monitor would be 0.7 volt, or well within the 0.2 to 5 volt sensitivity range of most video monitors.



Philco Corporation's Government and Industrial Division uses its own closed-circuit industrial television system for security control in its main plant in Philadelphia. By using CCTV, one plant guard can observe the entrances to three classified areas. Employees appear on the monitor to be identified by the plant guard here.

In a typical basic r.f. system, the video amplifier is replaced by an r.f. modulator whose output is a v.h.f. channel (2 to 13) on which the camera signal along with synchronization signals are impressed. This v.h.f. output is then fed to the antenna terminals of a conventional TV receiver. In the *Blonder-Tongue* system shown on page 35, r.f. modulator output is 1 volt, and .5 volt video output is also available directly from the control generator.

Cameras and Controls

Television cameras for CCTV use are available in several sizes and levels of versatility, from the large studio-type cameras used in commercial telecasting down to a tiny camera slightly larger than a pack of cigarettes. The very largest, such as the studio broadcast type *RCA* model TK-30A, uses the image orthicon pickup tube type 5820. Some smaller cameras utilize the image dissector type of pickup tube. But the vidicon type 6198 pickup tube has found most favor for CCTV because it combines small size with good resolution (about 600 lines) and adequate sensitivity. The 6198 is 1-inch in diameter and about 6 inches long. The raster on the face of the tube is about 1/2" by 3/8". A smaller vidicon tube of 1/2" diameter is in existence. Cameras have been developed small enough to fit into the drilling shaft of an oil well. Cameras are also available with ex-

plosionproof, weatherproof, and underwater housings for unusual assignments. And at least two of the large firms in the field are now developing color cameras designed primarily for application in the closed-circuit television field.

Selection of camera type depends, of course, on the particular CCTV application in which it is to be used. For remote placement in dangerous, inaccessible, or inconvenient locations, the camera need mount only an optical focus control. Other adjustments (beam, gain, target, and electrical focus) are made on a separate control unit usually incorporated into the control generator, which can then be installed at a more convenient or safe position. Viewing of the image before the camera's lens is done on the video monitor or receiver at the final observation position. In one system, the *RCA* ITV.6, the camera control unit is combined with a video monitor in an integral unit.

Cameras intended for studio-type use (such as the *Kin-Tel* and the *Dage* 101) contain their own viewfinders. Some cameras (the *Du Mont* 100) contain their own full set of controls. Three and 4-lens turrets, remote, powered control of lens aperture and optical focus, rear controlled, and even remotely controlled lens turret rotators are also offered.

Large studio-type image orthicon cameras utilize lenses normally used

(Continued on page 146)



Amazing New Handbook Takes The "Headache" Out of TV Trouble Shooting

SAVES TIME . . . ELIMINATES GUESSWORK!
Now, a simple, practical way to accurately spot the cause of trouble in any TV set, FAST! Quick, easy-to-understand tests tell you in which of 5 TV set sections to find the cause of trouble. Fool-proof Check Charts help you locate the exact trouble spot at once. From as many as 700 possibilities. Book fits easily into your tool kit for handy on-the-job use. Over 300 spiral bound fast reference pages with 50 time-saving Check Charts; dozens of easy to understand diagrams and tests; explanations of circuits and designs. The hours and aggravation this amazing handbook can save you on a single servicing job more than pay its low price!

USE IT ON 7 DAYS FREE TRIAL!

Send no money, just the coupon. We'll rush your copy on FREE TRIAL. After 7 days, send only \$3.95 plus postage or return the book and owe nothing. Act Now!

MAIL COUPON NOW!

Educational Book Publishing Div.
COYNE ELECTRICAL SCHOOL, Dept. 58-RT
500 S. Paulina St., Chicago 12, Ill.

Rush TV handbook for 7 days FREE TRIAL per offer.

Name Age

Address

City Zone State

Check here if \$3.95 enclosed. We pay postage. 7-day money-back guarantee.

TUBES

Used Tubes! Electrically Perfect Factory Seconds! Brand New Factory Seconds! New and Used Jan Surplus Tubes!

- INDIVIDUALLY BOXED!
- GUARANTEED ONE YEAR!

- FACTORY BOXED
- FACTORY IRREGULARS
- NEW JAN SURPLUS
- EQUIPMENT TUBES

ALWAYS 1000 TYPES IN STOCK

EXPORT ORDERS INVITED MANUFACTURERS ORDERS INVITED

PROMPT DELIVERY
ONE YEAR MONEY
BACK GUARANTEE

FREE 12" TV SET

with every receiving tube order of \$100.00 or more!

FREE 16" TV SET

with every receiving tube order of \$200.00 or more!

Bonus TV sets are shipped complete with cabinet and picture tube F.O.B. our warehouse. With slight adjustments and minimum labor they can be restored like new.

QZ4	.42	5AT8	.79	6BK7	.75	7A4	.46	12J5	.39
1A7GT	.42	5I6	.79	6BL7GT	.74	7A5	.52	12L6	.59
1B3GT	.66	5T8	.79	6H7	.57	7A6	.44	12S47	.47
1C5GT	.40	5U4G	.48	6BQ6GT	.79	7A7	.44	12S67	.54
1C6	.25	5U8	.79	6BQ7	.75	7A8	.44	12S7J	.44
1C7	.25	5V8	.49	6BY5GT	.57	7A7U7	.63	12SK7	.47
1D5GP	.42	5V6GT	.49	6BZ7	.75	7B4	.44	21L7GT	.59
1H4G	.45	5X8	.79	6C4	.36	7B5	.40	12S7N7GT	.56
1J6GT	.46	5Z3	.44	6CB6	.50	7B6	.41	12SQ7	.39
1L4	.45	5Y4G	.38	6C06G	1.75	7B7	.42	12V6GT	.44
1L6	.54	5Z3	.44	6C06	.79	7B8	.46	12W6	.59
1L7	.55	5Z3	.44	6D6	.47	7C4	.40	12X4	.39
1L8A	.46	5A8	.46	6E5	.47	7C5	.41	1447	.44
1L8A	.58	6A84	.44	6F5	.36	7C6	.42	14B6	.44
1L8C	.48	6AC7	.66	6F6	.37	7C7	.44	14Q7	.44
1L8E	.45	6AF4	.75	6F7	.37	7E5	.44	19T8	.69
1L8D5	.56	6AG5	.49	6J4	1.59	7E6	.44	19B6GG	1.17
1LE3	.56	6AG7	.68	6J5	.38	7E7	.48	25BQ6GT	.84
1LH4	.63	6AH4G2	.69	6J6	.48	7F7	.58	25CA5	.79
1LN5	.46	6AH6	.70	6K6GT	.38	7F8	.65	25CD6	1.29
1NSGT	.49	6AK5	.53	6K7	.38	7G7	.74	25CU6	.99
1R5	.50	6AL5	.41	6L6	.48	7N7	.51	25L6GT	.46
1S5	.45	6AM8	.79	6N7	.59	7Q7	.58	25W4GT	.42
1T4	.50	6AN8	.79	6Q7	.39	7X7	.64	25Z6	.36
1U4	.56	6AQ5	.45	6S4	.39	7Y4	.34	27L6	.44
1U5	.45	6AS5	.47	6S8GT	.70	7Z4	.39	35B5	.47
1V2	.70	6AS7G	2.25	6SA7	.47	12A4	.59	35C5	.47
1X2	.66	6AT6	.38	6SB7Y	.47	12A6	.60	35D5	.47
2A3	.49	6AT8	.79	6SC7	.47	12A85	.59	35L6GT	.46
2A7	.54	6AU4GT	.64	6SG7	.40	12A05	.49	35V4	.38
2D21	.95	6AV5GT	.60	6SH7	.42	12A76	.65	35Y4	.38
3A4	.50	6AUG	.42	6S7J	.42	12A77	.65	35Z5GT	.38
3A5	.50	6AUB	.79	6SK7	.49	12A06	.42	39/44	.25
3AL5	.52	6AV5GT	.64	6SL7GT	.56	12A07	.58	50A5	.47
3A06	.52	6AV6	.38	6SN7GT	.56	12AV6	.61	50B5	.47
3B26	.57	6AW8	.89	6SQ7	.40	12A7V	.66	50C5	.47
3BC5	.57	6AX4GT	.65	6S57	.40	12AX4GT	.64	50L6GT	.44
3B6G	.57	6AX5GT	.56	6T4	.85	12A77	.62	80	.39
3C86	.57	6BA6	.46	6T8	.67	12A27	.62	84/624	.45
3Q4	.55	6BC5	.49	6U5	.54	12B4	.67	117L7GT	1.25
3Q5GT	.56	6BC8	.89	6U8	.79	12B7	.59	117N7GT	1.25
3S4	.46	6BDSGT	.52	6V3	.79	12B7A	.59	117P7GT	1.25
3V4	.55	6BE6	.45	6V6GT	.45	12BEG	.45	12C6	.36
4B7	.75	6B75	.39	6W4GT	.39	12B7	.59	12C6	.36
4BZ7	.75	6BGGC	1.17	6W6GT	.52	12B7V	.45	12C6	.36
5AM8	.79	6BH6	.50	6X4	.38	12CA5	.59	12C6	.36
5AN8	.79	6BI6	.46	6X5	.38	12C6	.59	12C6	.36
5A95	.49	6BK5	.67	6X8	.74	12D06	.79	12Z6GT	.61

Receiving Tubes Sent Parcel Post

FREE! TWO SET COUPLER WITH EVERY TUBE ORDER OF \$8.50 OR MORE!!

FREE POSTAGE! On All Orders Shipped in U. S. A., Territories and A.P.O.'s. Send 25c for handling on orders under \$5.00. Please send approx. postage on Canadian and foreign orders. Excess will be refunded.

STANDARD LINE

ELECTRIC COMPANY

432 HARRISON AVENUE, HARRISON, N. J. - Phone: HUmboldt 4-4997

COMPLETE TRAINING FOR BETTER RADIO-TV SERVICE JOBS



Let these two world-famous Ghirardi training books teach you to handle all types of AM, FM and TV service jobs by approved professional methods—and watch your efficiency and earnings soar!

Completely modern, profusely illustrated and written so you can easily understand every word, these books pave the way to fast, accurate service on any type of radio and TV set ever made. Each book contains the latest data on the latest methods and equipment—NOT a re-hash of old, out-of-date material. Each is co-authored by A. A. Ghirardi, whose famous RADIO PHYSICS COURSE and MODERN RADIO SERVICING were, for 20 years, more widely used for military, school and home study training than any other books of their type!

THE NEW Ghirardi RADIO-TV SERVICE LIBRARY

Almost 1500 pages and over 800 clear illustrations show step-by-step how to handle every phase of modern troubleshooting and servicing.

1—Radio and Television Receiver TROUBLESHOOTING AND REPAIR

A complete guide to profitable professional methods. For the beginner, it is a comprehensive training course. For the experienced serviceman, it is a quick way to "brush up" on specific jobs, to develop improved techniques or to find fast answers to puzzling service problems. Includes invaluable "step-by-step" service charts. 820 pages, 417 illus., Price \$7.50 separately. (Outside U.S.A. \$8.00.) See combination offer below!

2—Radio and Television Receiver CIRCUITRY AND OPERATION

This 669-page volume is the ideal guide for servicemen who realize it pays to know what really makes modern radio-TV receivers "tick" and why. Gives a complete understanding of basic circuits and circuit variations; how to recognize them at a glance; how to eliminate guesswork and useless testing in servicing them. 417 illus. Price separately \$6.75 (outside U.S.A. \$7.25).

New low price...you save \$1.25!

If broken into lesson form and sent to you as a "course," you'd regard these two great books as a bargain at \$50 or more! Together, they form a complete modern servicing library to help you work faster, more efficiently and more profitably. Completely indexed so you can look up needed facts in a jiffy.

Under this new offer, you save \$1.25 on the price of the two books—and have the privilege of paying in easy installments while you use them! No lessons to wait for. You learn fast—and you learn right!

STUDY 10 DAYS FREE!

Dept. RN-58 RINEHART & CO., Inc.
232 Madison Ave., New York 16, N. Y.

Send book(s) below for 10-day FREE EXAMINATION. In 10 days, I will either remit price indicated (plus postage) or return books postpaid and owe you nothing.

Radio & TV Receiver TROUBLESHOOTING & REPAIR (Price \$7.50 separately)

Radio & TV Receiver CIRCUITRY & OPERATION (Price \$6.75 separately)

Check here for MONEY-SAVING COMBINATION OFFER. Save \$1.25. Send both of above big books at special price of only \$13.00 for the two (Regular price \$14.25) . . . you save \$1.25. Payable at rate of \$4 (plus postage) after 10 days if you decide to keep books and \$3 a month thereafter until \$13 has been paid.

Name

Address

City, Zone, State,

Outside U.S.A.—\$8 for TROUBLESHOOTING & REPAIR; \$7.25 for CIRCUITRY & OPERATION; \$14 for both. Cash with order only, but same 10 day return privilege.

in 35 mm. motion picture work. Vidicon cameras, which constitute the most popular and widely used type, are designed to receive lenses originally designed for 16 mm. movie cameras. The "normal" or general purpose lens for a vidicon camera is a type "C" interchangeable mount lens of 1" focal-length and f/1.9 or f/1.5 speed. Such a lens provides a horizontal field of view 5 feet wide at an object distance of 10 feet. A wide variety of type "C" mount lenses in wide-angle and telephoto focal-lengths are available for special applications, including zoom type lenses which are variable in focal-length from 1.2 to 6 inches.

Scanning Standards

Most CCTV camera and control equipment is designed around the American broadcast television scanning standard of 525 lines per frame, 30 frames per second, with 60 fields per second interlaced 2 to 1. The advantage of such standardization is compatibility: it permits CCTV cameras to be used with conventional TV receivers, and also facilitates tying in a CCTV system to a broadcast network if required.

On the other hand, some special equipment utilizes non-standard scanning standards, such as random interlace, non-interlace, extra fine horizontal line structure (for special, high resolution needs), and slow-scan (for facilitation of transmission of picture information in a narrow bandwidth over telephone lines). Still more specialized equipment operates with a spiral-type of scan, and TV equipment is available for display of picture information on screens different in aspect ratio from the conventional 4 to 3.

Audio

In many applications such as teaching, convention coverage, sales meetings, or in two-way visual communications, sound is a necessity. In a strictly video installation a separate audio system—microphone, amplifier, speaker—must be used, since video monitors make no provision for sound reproduction. In an r.f. installation a separate audio system can be employed; or an audio-video mixer may be used to incorporate sound with picture in the single channel v.h.f. output with a 4.5 megacycle picture-to-sound spread, which is equivalent to over-the-air transmission standards. The TV receiver will then reproduce both picture and sound. Which of the two methods is employed is a matter of economics. Where only a few TV receivers are involved, a separate audio system may be more practical. However, when many receivers are to be covered, it becomes less costly to utilize an audio-video mixer.

All in all, it would appear that closed-circuit TV, which is hardly out of its swaddling clothes, is headed for a bright, unlimited future.

BE QUALITY WISE . . . BUY QUAL-KITS!



HI-FI AMP. KIT
Complete 6 tube-10 watt amplifier. Push-pull beam power output, built-in pre-amp, 5 position selector switch, 3 position record equalization, LP, RIAA, Eur. Response 1/2 db. 20-20,000 cps. Output 10 watts at less than 2% IM. Low noise level and harmonic distortion. **\$28.50**

Every kit complete with 28 page fully illustrated instruction and assembly manual. Cover and legs optional.



HI-FI AM-FM TUNER KIT
Advanced 7 tube circuit plus Rectifier for full sensitivity and selectivity. Distortion less than 1%. Sensitivity is 5 uv for 30 db quieting on FM, 25 uv AM. Armstrong FM Circuit with limiter. Foster-Seeley Discriminator. 20-20,000 cps response. Full AFC control — no drift. Easy assembly. **\$28.95**

Add 10% Fed. Tax. Write for FREE catalog and name of nearest dealer carrying these remarkable units.

QUALITY-ELECTRONICS

319 Church St. Dept. T-5, New York 13, N. Y.

TREMENDOUS SAVINGS ON PRECISION RESISTORS

Manufactured by leading company. 1% tolerance carbofilm, HiStability, Low temperature co-efficiency. New, Popular Ohmage.

5 lb. assortment of 1/2, 1 and 2 watts \$5.00
10 lb. assortment \$9.00

Please include postage with order.

UNITED SALES COMPANY
537 State Street Ithaca, New York

ENGINEERING DEGREES

E.E. Option Electronics or Power

Earned through Home Study Residence classes also available (Operating as a College of Engineering only at present)

5719R Santa Monica Blvd. Hollywood 38, California

CODE SENDING SPEED

Be a "key" man. Learn how to send and receive messages in International Morse code. Communicate with operators around the globe. Learn at home quickly through famous Candler System. Used by best operators. Quality for Amateur or Commercial License. Write for FREE BOOK.

CANDLER SYSTEM CO., Dept. 2-E, Box 9226, Denver 20, Colo., U.S.A.

ENGINEERING B.S. DEGREE IN 27 MONTHS

Prepare for unlimited opportunities of the Electronic Age! Earn your B.S. DEGREE IN 27 MONTHS in Aeronautical, Chemical, Civil, Electrical or Mechanical Engineering; in 36 MONTHS in Mathematics, Chemistry, Physics. Intensive, specialized courses. Comprehensive training in electronics, television, advanced radio theory and design, math, nuclear physics and electronic engineering. Engineering Science Preparatory courses. Low rate. Graduates in demand. Spacious campus; 20 bldgs., dorms, gym, playing field. Earn part of your expenses in Fort Wayne while studying. G.I. approved. Enter June, Sept., Dec., March.

INDIANA TECHNICAL COLLEGE
958 E. Washington Blvd., Fort Wayne 2, Indiana

Please send me free information on B.S. ENGINEERING DEGREE IN 27 MONTHS as checked.

Electronics Chemical Aeronautical
 Civil Mechanical Electrical

B.S. DEGREE IN 36 MO. IN Math. Chem. Physics

Name

Address

RADIO TV TUBES
WHAT A BUY
DYNAMIC
HIGH FIDELITY FOR LESS

Sales Aids

PREMIUM PROGRAM

Ram Electronics has launched a special program for its TV sweep and related components.

Depending upon the number of the firm's components a service technician buys, he may qualify for interesting premiums such as appliances, tools, etc. under the new "Share in Pleasure" plan.

Further details are available by writing directly to the company, 600 Industrial Ave., Paramus, N. J.

"IRISH" BANNER

ORRadio Industries, Inc. is featuring a handsome three-color banner



which is being used to advantage by dealers to attract more customers and to increase recording tape sales.

The white satin sheen banner is 21 inches wide and 28 inches long and the art work is in green and black.

Used on the wall, it attracts the attention of customers in the shop. Placed in the window, it catches the eye of sidewalk traffic.

Any dealer or distributor handling recording tape may obtain the display, without cost, by sending a postcard to the firm, Shamrock Circle, Opelika, Ala., attention of F. R. O'Sheen.

"DO-IT-YOURSELF" DISPLAY

A new counter display that enables customers to see how simple it is to tune a color TV receiver is being made available to RCA Victor dealers.

The multi-color "Do-It-Yourself" contains a back-lighted color transparency arrangement that operates like a color TV picture. Two knobs work like the "Tint" and "Color" controls on the firm's color receivers. The knobs are tuned according to the simple 3-step directions printed on the display and the customer sees what happens when an actual set is tuned.

When the unit is not being used to demonstrate tuning, it can be con-

MAKE SURE IT FITS!





OXFORD SPEAKERS

You obtain the finest sound reproduction when you select the proper speaker for the specific application. Each OXFORD SPEAKER is "tailor-designed" to actually "fit the need."

Specify OXFORD when you next require quality speakers. Remember: Oxford quality has consistently been superior for over thirty years.



Our new catalog is available write for yours NOW!

<h4>RADIO & TV SPEAKERS</h4>  <p>OXFORD Speakers are used by more original set manufacturers — find out why!</p>	<h4>OUTDOOR SPEAKERS</h4>  <p>For rugged, steady performance under any conditions, OXFORD Weather-proof speakers will meet the need.</p>
<h4>DUAL CONE HI-FI SPEAKERS</h4>  <p>Oxford's newest development to provide maximum performance. For Hi-Fi and rear deck applications.</p>	<h4>PORTABLE RADIO SPEAKERS</h4>  <p>More Oxford speakers are used in portable sets than ever before — there must be reasons!</p>

OXFORD Components, Inc.
Subsidiary of Oxford Electric Corp.
556 West Monroe Chicago 6, Ill
Exports: Rebum Agencies, New York City
In Canada: Atlas Radio Corp., Ltd., Toronto



Genuine OAK WOOD Antique TELEPHONES!
As is \$9.00 complete. Tested working order \$12.00. Shipments FOB Simpson, Pa. Write for free list.
Telephone Engineering Co.
Dept. RT5 Simpson, Pa.

TAPE RECORDERS
HI FI COMPONENTS
Tapes—Accessories
UNUSUAL VALUES
Send for Free Catalog
DRESSNER
69-02 RA-174 St.
Flushing 65, N. Y.

MERITAPE
Low Cost, High Quality Recording Tape—in boxes or cans.

EXPECTING A CHECK? You'll get it quicker if you give your postal delivery zone number with your address.

The Post Office has divided 106 cities into postal delivery zones to speed mail delivery. Be sure to include zone number when writing to these cities; be sure to include **your** zone number in **your** return address—after the city, before the state.

"ONE DOLLAR" buys

As much as \$15 worth — Everything Brand New and sold to you with a money back guarantee.

DEDUCT 10% ON ANY ORDER OF \$10 OR OVER

Plus a FREE SURPRISE PACKAGE

- 100 — ASSORTED FUSES popular sizes.....\$1
- 100 — ASST. 1/2 WATT RESISTORS some 5% \$1
- 70 — ASSORTED 1 WATT RESISTORS.....\$1
- 35 — ASSORTED 2 WATT RESISTORS.....\$1
- 50 — ASST. TUBULAR CONDENSERS.....\$1
- 10 — 6' ELECTRIC LINE CORDS with plugs....\$1
- 5 — TV CHEATER CORDS with both plugs....\$1
- 4 — 50' SPOOLS HOOK-UP WIRE 4 colors...\$1
- 50 — STRIPS ASST. SPAGHETTI best sizes...\$1
- 200 — ASST. RUBBER GROMMETS best sizes...\$1
- 100' — TWIN LEAD-IN WIRE 300Ω heavy duty..\$1
- 50' — FLAT 4-CONDUCT. WIRE many purposes..\$1
- 25' — INSULATED SHIELDED WIRE.....\$1
- 1 — \$7 INDOOR TV ANTENNA hi-gain 3 section \$1
- 20 — ASST. TV KNOBS, ESCUTCHEONS, Etc..\$1
- 4 — ASST. TOGGLE SWITCHES spst, dpdt, etc..\$1
- 15 — ASST. ROTARY SWITCHES \$15 worth...\$1
- 100' — FINEST NYLON DIAL CORD best size...\$1
- 200 — SELF TAPPING SCREWS #8 x 1/2"....\$1
- 35 — ASST. RADIO KNOBS screw and push-on..\$1
- 100 — KNOB SPRINGS standard size 3/8" x 1/2" . \$1
- 100 — ASSORTED KNOB SET-SCREWS.....\$1
- 25 — ASSORTED CLOCK RADIO KNOBS.....\$1
- 400 — ASST. H'DWARE screws, nuts, rivets, etc..\$1
- 50 — ASST. SOCKETS octal, noval and miniature..\$1
- 20 — ASSORTED TUBE SHIELDS best sizes...\$1
- 50 — ASST. MICA CONDENSERS some in 5%..\$1
- 50 — ASST. CERAMIC CONDENSERS.....\$1
- 10 — ASST. VOLUME CONTROLS less switch..\$1
- 5 — ASST. VOLUME CONTROLS with switch...\$1
- 100 — VOLUME CONTROL HEX NUTS.....\$1
- 20 — ASST. PILOT LIGHTS popular types.....\$1
- 10 — PILOT LIGHT SKTS. bayonet type, wired..\$1
- 50 — ASST. TERMINAL STRIPS 1, 2, 3, 4 lug..\$1
- 10 — ASST. RADIO ELECTRO. CONDENSERS..\$1
- 5 — ASST. TV ELECTROLYTIC CONDENSERS..\$1
- 15 — ASST. TV COILS sync. peaking, width, etc..\$1
- 25 — ASST. MICA TRIMMER CONDENSERS..\$1
- 50 — TUBULAR CONDENSERS .02-400v.....\$1
- 50 — TUBULAR CONDENSERS .001-600v.....\$1
- 15 — TUBULAR CONDENSERS .047-600v.....\$1
- 50 — TUBULAR CONDENSERS .01-400v.....\$1
- 2 — ELECTROLYTIC COND. 40/40-450v.....\$1
- 2 — ELECTROLYTIC COND. 40/10/10-450v...\$1
- 30 — FP CONDENSER MOUNTING WAFERS..\$1
- 3 — ELECTROLYTIC COND. 80-450v.....\$1
- 3 — ELECTROLYTIC COND. 50/30-150v.....\$1
- 15 — TUBULAR CONDENSERS .015-1600v.....\$1
- 10 — HV TUBULAR CONDENSERS .006-1600v...\$1
- 10 — HV TUBULAR CONDENSERS .001-6000v...\$1
- 10 — HV TUBULAR CONDENSERS .003-6000v...\$1
- 35 — MICA COND. 20-100 mmf & 15-270 mmf...\$1
- 35 — MICA COND. 20-470 mmf & 15-680 mmf...\$1
- 35 — MICA COND. 20-520 mmf & 15-1000 mmf...\$1
- 35 — CERAMIC COND. 20-5 mmf & 15-10 mmf...\$1
- 35 — CERAMIC COND. 20-25 mmf & 15-47 mmf...\$1
- 35 — CERAMIC COND. 20-35 mmf & 15-83 mmf...\$1
- 35 — CERAMIC COND. 20-100 mmf & 15-150 mmf...\$1
- 35 — CERAMIC COND. 20-270 mmf & 15-470 mmf...\$1
- 35 — CERAMIC COND. 20-1000 mmf & 15-1500 mmf...\$1
- 35 — CERAMIC COND. 20-2000 mmf & 15-5000 mmf...\$1
- 50 — 100Ω 1/2 WATT RESISTORS 5%.....\$1
- 75 — 470KΩ 1/2 WATT RESISTORS 10%.....\$1
- 50 — 3.3Ω 1 WATT RESISTORS 10%.....\$1
- 50 — 3.3Ω 1 WATT RESISTORS 10%.....\$1
- 50 — 15KΩ 1 WATT RESISTORS 10%.....\$1
- 50 — 470KΩ 1 WATT RESISTORS 10%.....\$1
- 25 — 2.2Ω 2 WATT RESISTORS 5%.....\$1
- 25 — 2.2Ω 2 WATT RESISTORS 10%.....\$1
- 25 — 100KΩ 2 WATT RESISTORS 10%.....\$1
- 10 — ASST. WIREW'ND RES. 5, 10, 20 watt...\$1
- 3 — AUDIO OUTPUT TRANS. 50L6 type.....\$1
- 3 — AUDIO OUTPUT TRANS. 6X6 or 6V6 type..\$1
- 3 — I.F. COIL TRANSFORMERS 456 kc.....\$1
- 3 — I.F. COIL TRANSFORMERS 10.7 mc FM...\$1
- 4 — OVAL LOOP ANTENNAS ass't hi-gain types \$1
- 3 — LOOPSTICK ANT. new ferrite adjustable...\$1
- 12 — RADIO OSCILLATOR COILS 456 kc.....\$1
- 3 — 1/2 MEG VOLUME CONTROLS with switch..\$1
- 5 — 50K VOLUME CONTROLS less switch....\$1
- 10 — SURE GRIP ALLIGATOR CLIPS.....\$1
- 1 — GOLD GRILLE CLOTH 14"x14" or 12"x18" \$1
- 1 — 5" PM SPEAKER alnico #5 magnet.....\$1
- 5 — SETS SPEAKER PLUGS wired.....\$1
- 10 — SETS PHONO PLUGS and PIN JACKS...\$1
- 2 — \$2.50 SAPPHIRE NEEDLES 4000 playings..\$1
- 5 — DIODE CRYSTALS 2-IN21 2-IN23 1-IN64 \$1
- 2 — SELENIUM RECTIFIERS 1-65 ma & 1-150 ma \$1
- 1 — TV VERT. OUTPUT TRANS. 10 to 1 ratio...\$1
- 5 — TV CRT. SOCKETS with 18" leads.....\$1
- 5 — HI-VOLT. ANODE LEADS with 18" leads..\$1
- 1 — TV RATIO DETECTOR TRANS. 4.5 mc.....\$1
- 5 — ASST. VHF TUNER STRIPS oscillator....\$1
- 1 — SET TV KNOBS standard type incl. decals..\$1
- 1 — LB SPOOL ROSIN CORE SOLDER 40/60..\$1
- 6 — SPIN TIGHT SOCKET SET 3/16" to 7/16" \$1
- 3 — TV ALIGNMENT TOOLS 5", 7", 12".....\$1

HANDY WAY TO ORDER—Simply tear out advertisement and pencil mark items wanted (dot in square is sufficient); enclose with money order or check. You will receive a new copy of this ad for reorders.

ON SMALL ORDERS—Include stamps for postage, excess will be refunded. Larger orders shipped express collect.

BROOKS RADIO & TV CORP.
84 Vesey St., Dept. B, New York 7, N. Y.

verted into a flasher display with the transparency flashing from black-and-white to full color. This new display is available through the company's distributors.

NEW DISPLAY RACK

Perma-Power Company has made available a new display rack to stimulate sales of "Tube Briteners" and "Color Television Service Aids." The rack holds twelve individual boxes, six in each of two rows, with ample room at the top to display one or two open boxes with the individual products exposed. The rack takes little space, but does a big job in creating impulse buying. The display may be hung on the wall or used on counters.

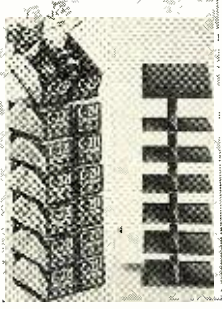

The firm's representatives are supplying the new display to its distributors at no cost.

DISPLAY PACKAGING

CBS-Hytron, Danvers, Massachusetts, has followed up its Diode Display-Dispenser Card for the type 1N64 with a second featuring the 1N34A.

The compact merchandiser is designed to display and dispense diodes in handy five-pack and single-pack sealed polyethylene envelopes.

A convenient reference list of the types the component replaces is a feature of this card. Write-in prices serve to emphasize the economy of the five-pack.

The Diode Display-Dispenser Cards for both the 1N64 and the 1N34A are

being displayed by the company's tube distributors.

NEW WALL CHART

A handy wall chart listing the company's exact replacement flybacks and yokes by original manufacturers' part numbers is available to technicians and distributors from Chicago Standard Transformer Corporation.

This chart, printed on index cardboard, lists each TV set manufacturer alphabetically. All units for which the firm has an exact replacement are listed in numerical order by manufacturer's part number. It provides the service technician and distributor with a quick, convenient way of determining the availability of an exact replacement unit.

Copies of this reference chart are available free of charge by writing to the company, 3501 Addison St., Chicago 18, Ill. and requesting DH-1.

TV HARDWARE DISPLAY

Television Hardware Mfg. Co., 400 S. Wyman St., Rockford, Ill., is now offering service dealers a new store display unit which features packaged sales of TV antenna hardware.

The basis of the new promotion is a sturdy display rack holding packages of everything from stand-offs to chimney mounts.

A total of 26 different hardware accessories is included in the new display deal. A balanced assortment of products provides 150 separate packages. The display unit itself is being offered free with the purchase of the complete hardware.

Service technicians wishing more information on "Deal 3912" should see their jobbers or write direct to the manufacturer.

Studying for a Novice ham license is a "family affair" as far as the radio code and theory classes being sponsored by Allied Radio is concerned. E. F. Bachner III and his father, E. F. Bachner, Jr. (left) pit their team against Fred Huettnner and his son, Charles. They are using the portable code training positions devised by Allied. Keys and jack boxes are mounted on boards which can be set up quickly at class time and dismantled when class is over. Two 14-week courses are offered by the company each year with a total enrollment upwards of 150 students. About two-thirds of those enrolling finish the course and, of these, 95 per-cent pass their FCC exams with flying colors.



YOUR DOLLAR STILL HAS PLENTY OF CENTS at RAD-TEL

- INSULATED RESISTORS.** Assorted values and assorted wattages. Ass't. of 100 **\$1**
- KNOB KITS.** Assorted Types. Bag of 30 **\$1**
- SOLDER LUG KITS.** Every usable assortment. Kit of 48 **\$1**
- MICA CONDENSERS.** All popular sizes. Kit of 25 **\$1**
- BY-PASS CONDENSERS.** .002 to .2MFD 200 to 1000 VDC. Kit of 25 **\$1**
- CERAMICON KITS.** Extra special buy. 2 Kits of 50 **\$1**

ELECTROLYTIC CONDENSERS

- 8 mfd 475v tubular. 10 for **\$1**
- 20 mfd. 450v. can. 5 for **\$1**
- 80 mfd 350v. can. 5 for **\$1**
- 250 mfd 350v. can. 5 for **\$1**
- 10, 100, 10, 100 mfd; 475, 300, 300, 25V-can. 3 for **\$1**

- VOLUME CONTROL KITS.** Assortment; some individually boxed. Kit of 10 **\$1**
- PRINTED CIRCUIT SOCKET.** 9 and 7 pin type. Kit of 25 **\$1**
- WIRED PLUGS, SOCKETS.** Very useful assortment. Kit of 20 **\$1**
- SPEAKER SELECTOR SWITCH.** For rear seat speaker. 3-position—either or both. 4 for **\$1**
- EM FOCUS COILS.** 250 ohms. 2 for **\$1**
- WIRE KIT.** Pre-cut, pre-trimmed. 3 lbs. **\$1**

FILTER CONDENSERS

- 20-20 MFD, 150V. 2 for **\$1**
- 40-40 MFD, 150V. 2 for **\$1**
- 50-30 MFD, 150V. 2 for **\$1**
- 80-120 MFD, 150V. 2 for **\$1**

- PILOT LIGHT SOCKET KIT.** 30 bayonet base socket wire leads, brackets, clamp and snap. Extra Special! 2 Kits for **\$1**
- CHEATER CORD.** Extra long; on & off switch. 10 ft. 5 inches. 2 for **\$1**
- YOKES 55°**, similar merit. MD 12. 10 for **\$1**
- PHONO MOTORS.** 60 cycle, 105/115V, 78 RPM. S11 List **\$1**
- BI-PASS CONDENSER KITS.** Ass'd. values .001-1 mfd. 200, 400, 600 V. mylar dielectric for top quality. 25 for **\$1**

TV, FM COIL KITS

- With peaking 4.5 mc ratio and 21.9 mc IF coils. Kit of 10 **\$1**
- Peaking Video IF, RF coils. Kit of 20 **\$1**
- CHIMNEY MOUNTS.** Standard, with instructions. 12 ft. galv. steel bands, complete. **\$1**
- VARIABLE CONDENSER with ADJ. PADDER.** 2 and 3 gang. Made for famous brand super-het. Kit of 5 **\$1**

POWER TRANSFORMER

700V tapped each side of center at 412V; 175-100 MA. Rect. 5.0 @ 3A; Fil. 5.0 @ 2A. List \$37.50 **\$1.95**

MAY SPECIAL

FILTER CHOKE—1 to 65 Henrys. 300 to 10 MA. Our Ass't. of 6 **\$3**

Use this ad as your order blank



Write Dept. RN-5 for FREE Catalog of Tubes & Parts. Subject to prior sale. No C.O.D.'s please, on this sale. Allow for postage.

55 CHAMBERS STREET NEWARK 5, N. J.

How G-Y Signal Is Used

(Continued from page 63)

I, Q, or some other demodulation axes?" The answer to this question is quite pertinent—the chrominance signals which are recovered from the transmission must finally be matrixed with the Y signal (luminance or monochrome component). If we choose R-Y, B-Y, and G-Y (red minus Y, blue minus Y, etc.) these chrominance signals can be matrixed with the Y signal in the picture tube itself (using the red, green, and blue grids, plus the cathode). By using the picture tube as the point for matrixing, we eliminate a considerable number of components which would otherwise increase the receiver cost.

With G-Y detectors coming into widespread use, color-bar generators are beginning to provide a (G-Y)/90-degree test signal. This is a signal which has the same relationship to G-Y as R-Y has to B-Y, or that I has to Q. In other words, a (G-Y)/90-degree signal is in quadrature to a G-Y signal or 90 degrees away in phase. Hence, if we apply a (G-Y)/90-degree signal to a G-Y detector, the detector will develop no output (null) when it is operating properly.

This is a test which is entirely similar to applying an R-Y signal to a B-Y detector and checking for a null. Or, the test is similar to applying an I signal to a Q detector and looking for a null. Now, it will be quite apparent from Figs. 2, 5, or 8 that an R-Y detector will not null on a (G-Y) 90-degree signal. Likewise, a B-Y detector will not null on a (G-Y) 90-degree signal.

In conclusion, it should be noted that many of the modern receivers which utilize R-Y and G-Y color detectors also make use of vestigial color sideband response in the i.f. strip. In this arrangement, the color signal does not fall on the flat top of the i.f. curve, but instead is located on the sloping side of the curve which is opposite the slope on which the picture carrier is located.

Vestigial color sideband reception makes possible some further economies in receiver construction, but it is also readily evident that the signal-to-noise ratio of the i.f. signal must be impaired somewhat, due to the 6 db attenuation of the burst and chroma signals in the i.f. amplifier. On the other hand, the impairment of the signal-to-noise ratio encountered in the i.f. amplifier can be largely compensated by use of R-Y and G-Y detection for reasons already discussed.

Hence, it is apparent that the G-Y signal along with its associate, the (G-Y)/90-degree signal, is assuming quite an important role in the present-day color service picture. It behooves us all to become better acquainted with G-Y and its use in color-TV reception.

NEW! hi-fi accessories YOU have been waiting for



vantron phono-booster

A hi-fi, fully transistorized phono pre-amplifier and equalizer. For use with high quality amplifiers with low output cartridges.

\$21.95*

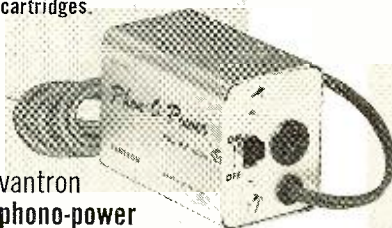

vantron phono-power

A hi-fi pre-amplifier power supply for monaural and stereophonic use. Provides hum-free power when used in conjunction with the phono-booster.

\$9.95*



vantron pow-r-check

A precision watt and db hi-fi power meter for monaural and binaural installations. Provides an accurate indication of power from the amplifier. Permits frequency response tests.

\$15.95*



vantron cross-over

A tubeless trouble-free precision cross-over divider network. Divides up the frequency spectrum when separate bass and treble power amplifiers are used.

\$8.95*

*Hi-Fi Users Net

See your distributor or write direct.

ELECTRONICS DIVISION

VAN NORMAN INDUSTRIES INC.

186 GRANITE ST., MANCHESTER, N. H.



STOP!
Demand the finest in
Electronic Test Equipment—
EMC, of course. You get
the most quality per
measurement dollar!

**NEW! EMC Model 301
Speedi Tube Tester**

Checks tubes in seconds. Checks shorts, leakages, and quality. Over 375 tubes, including 0Z4, now listed. New listings available. Checks and rejuvenates Picture Tubes with Model PTA (Picture Tube Adaptor), at only \$4.50. Model 301P (illustrated),

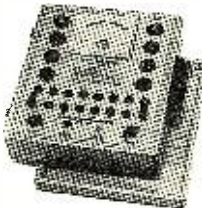

with 4½" meter & oak Carrying case \$47.50
Kit 33.20
Model 302C, (with 7½" meter) \$2.90
Kit 47.90

**NEW! EMC Model 108
Handi Tester**

The only appliance and auto battery tester in its price class to use a D'Arsonval, instead of an iron vane type meter. Gives exclusive advantages of maximum accuracy and scale length, and minimum battery replacement cost . . . at no added charge. Complete with test leads and instruction manual.



Wired \$15.95 Kit 12.95

**NEW! EMC Model 905-6A
Battery Eliminator, Charger,
and Vibrator Checker**

A MUST for auto radio service. Features continuously variable voltage output — in either 6 or 12 volt operation. Checks all 6 or 12 volt vibrators.



Wired \$67.90 Kit 44.90

**NEW! EMC Model 601,
Wide Band Oscilloscope
for Color & Monochrome TV**

Features full 5 mc band with push-pull vertical amplifier with sensitivity .02 volts per inch, retrace blanking amplifier for clearer pictures, and multivibrator sweep from 15 cycles to over 75 kilocycles. Wired and tested ...\$117.90

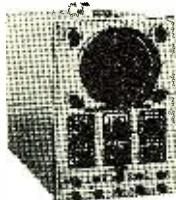

**NEW! EMC Model 206P
Dynamic Mutual Conductance Tube Tester**

The lowest priced mutual conductance tube checker on market. Checks tubes for microhm value and gas content. Completely flexible switching. Your best buy in a quality tube tester. (Hand rubbed Carrying Case)\$83.50



Yes, tell me more, send me—FREE— RN-5
a detailed catalog of the complete EMC line.

NAME _____
STREET _____
CITY _____ STATE _____

EMC

Electronic Measurements Corp.
625 B'way • New York 12, N. Y.
Ex. Dept. 370 B'way, N. Y. 13

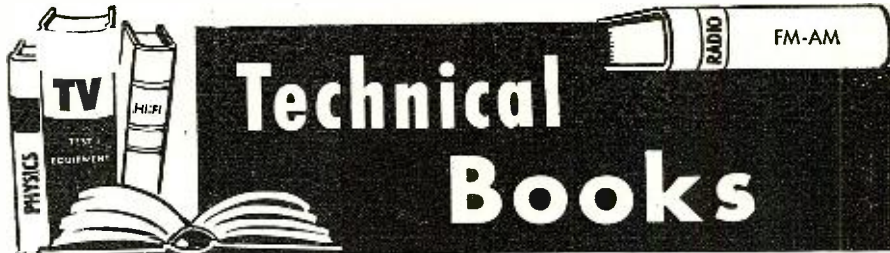

"TAPE RECORDER MANUAL" compiled by Sams Staff. Published by *Howard W. Sams & Co., Inc.*, Indianapolis, Ind. 148 pages. Price \$2.95. (Vol. 1.)

This is the first of a new series of service manuals covering tape recorders which is being offered to meet the increased demand for more comprehensive material on current-model tape recorders.

This first volume covers seven basic tape recorder chassis and two tape players released to the public during 1956 and 1957. Both home and professional type units are covered. The information provided includes general operation data, use of external speakers, mechanical and amplifier adjustments, cleaning, lubrication, etc. There is complete information on troubles and probable remedies, plus complete mechanical and electrical parts lists on each unit.

Photos show the actual recorder and amplifier, while the exploded view drawing gives complete assembly and parts list information. Schematics are included for the amplifiers, where required.

This volume should be of interest to both technicians and audiophiles who want to make adjustments on their own tape systems.

"AUTOMATIC RECORD CHANGER SERVICE MANUAL" by Sams Staff. Published by *Howard W. Sams & Co., Inc.*, Indianapolis. 148 pages. Price \$2.95. Paper bound. (Vol. 10)

This most recent addition to this publisher's record changer service series covers ten units produced during 1956 and 1957.

Collaro, Crescent, Garrard, Miracord, Philco, RCA, Silvertone, Telefunken, V-M, and Webcor units are covered in this volume, with general specifications, operation data, changer cycle, mechanical adjustments, lubrication points, etc. included for each model.

In addition, the manual carries troubleshooting procedures and steps to take to remedy the fault. Mechanical and electrical components lists are given along with the over-all and exploded views of each changer covered by this volume.

"SELECTION AND APPLICATION OF METALLIC RECTIFIERS" by S. P. Jackson. Published by *McGraw-Hill Book Company, Inc.*, New York, 324 pages. Price \$8.00.

This volume has been written for engineers and technicians as an aid to the proper selection and application of

metallic rectifiers in a wide variety of electronic and electrical equipment designs.

Information is provided on the fundamentals and characteristics of these components, along with basic rectifier circuits and their related circuitry. One section deals with the general characteristics of metallic rectifier cells and provides a guide to the selection of the appropriate component.

The general discussion of the subject includes information on ratings, rating methods, and how to use typical data as provided by rectifier manufacturers.

The author, who is manager of commercial equipment engineering for *General Electric's* rectifier department, has kept his treatment of his subject as practical and potentially useful as possible. Since it has been assumed that this text will be used by those with a sound engineering background, the author hasn't hesitated to use mathematical "shortcuts" in dealing with his subject where indicated.

"BASIC TELEVISION" by A. Schure. Published by *John F. Rider Publisher, Inc.*, New York. Five Volumes. Price \$10.00 the set. Paper bound. Single cloth-bound edition, \$11.50.

For those who have thought about studying television but have been intimidated by the complexity of the average engineering text, this easy-to-take introduction to the subject should be encouraging. It is about as non-technical a treatment as it is possible to present about what is, essentially, a technical subject.

The author has based his presentation on the proven principle that "a picture is worth a thousand words." The text is lavishly illustrated with sketches, line drawings, cartoons, etc. to point up analogies and explain pertinent information.

The five volumes comprising this set cover the transmitter, the organization of the TV receiver, and an explanation of TV receiver circuitry (in three volumes). There is no reason why the student with an elementary radio and electronics background couldn't use this "course" as a springboard to a career as a service technician in the television field.

"TELEVISION INTERFERENCE, ITS CAUSES AND CURES" by Phil Rand. Published by *Nelson Publishing Company*, Redding Ridge, Conn. 56 pages. Price \$1.75. Paper bound.

This book has been written by a

well-known ham, W1DBM, for his fellow amateurs as well as for the information and instruction of electronic engineers, television technicians, and television viewers.

The text is divided into ten chapters and six appendices. The body of the text deals with such problems as the sources and types of TVI, running down TVI, the television receiver, the radio transmitter, shielding and filtering, special v.h.f. problems, the design and use of high- and low-pass filters, external harmonic generation, and TVI from industrial, medical, and power sources. The appendix carries a fairly extensive bibliography on the subject, a list of TVI committees, a table of amateur band harmonic frequencies, a listing of U.S. TV channels and frequencies, tables of world-wide TV standards and channels, and excerpts from pertinent FCC rules.

With so much radio-controlled equipment on the market and so many services vying for the limited spectrum space, TVI is a growing problem and all those who operate or are responsible for the correct functioning of any equipment which might produce spurious signals would do well to read and heed the author's advice.

* * *

"TV AND RADIO TUBE TROUBLES" by Sol Heller. Published by *Gernsback Library, Inc.*, New York. 220 pages. Price \$2.90 (soft cover), \$4.60 (hard cover).

While this volume is directed mainly to the less experienced service technician there are lots of pertinent and helpful data that the old timers can and should use. This statement applies particularly to the first chapter which deals with, of all things, safety! The "old hand" is often the first to become careless due to his familiarity with the job and the product. This chapter should be "must" reading for all service technicians every six months.

It is unfortunate that, despite all sorts of safety campaigns and drives, year after year service work takes its toll of fingers and eyes among those in too much of a hurry to take the most elementary precautions.

It is the author's contention that much valuable service time is dissipated simply because technicians refuse to associate certain circuit faults with tube failures. The balance of the text is devoted to a discussion of the various faults that can be traced to tube failure or aging. The chapters cover tube and component damage, tube troubles in TV, picture and sound troubles, sync troubles, interference,—all caused by tube malfunction, picture tubes, radio tube troubles, and the replacement of tubes.

This is a new approach to service work and if, as the author contends, 70 per-cent of all service troubleshooting involves running down faulty tubes, this book should go a long way toward stepping up service output. —30—

NEW IMPROVED SENCORE LC3 Leakage Checker

Another Sencore Time-Saver



Check these outstanding New Features

Now — For the first time . . .

- Checks 130 different tube types — more than any other "grid circuit" type checker. Includes UHF and latest type tubes.
- Checks picture tubes without removing tube from cabinet or chassis.
- New Roll Chart prevents obsolescence — just dial the tube type and save time. Chart is easily replaced at no extra cost.
- Dynamic Filament checks including heater to cathode leakage & shorts — no need for a second filament tester.
- Two spare preheating sockets to cut down testing time.
- Capacitor checks simplified.

The LC3 provides all these new improved features in addition to those employed in earlier leakage or "grid circuit" testers. A must for any TV service technician.

SERVICING

SERVICE

INSTRUMENTS CORP.

171 Official Rd • Addison, Ill.

\$28.95

DEALER NET

Really Whips Tough Dogs

In stock at your local parts distributor

Cut out this ad now for further information

Just Out

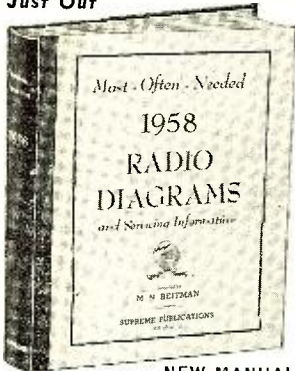

NEW MANUAL

Be prepared to repair quickly all new 1958 radio sets. In this big volume you have easy-to-use, large schematics, needed alignment data, replacement parts lists, voltage values, and information on stage gain, location of trimmers, and dial stringing, for almost every 1958 radio. Includes auto radios, transistor portables, and all types and makes of home sets. Giant in size, 8 1/2 x 11 1/2; manual style, sturdy binding. Price, only **\$2.50**

New SUPREME 1958 Radio Manual

Now you can benefit and save money with **Supreme** amazing scoop of 1958. This one giant volume has all the service data you need on all recent radio sets. A full year of models of all popular makes, home and auto sets, portable radios, combinations, changers, all included. The full price for this mammoth 1958 manual is only \$2.50, nothing else to buy for a whole year. Other **Supreme** radio service volumes for previous years (mostly at \$2) are described below. Separate **TV** manuals are listed at right.

SUPREME RADIO MANUALS FOR PREVIOUS YEARS

Use **Supreme** manuals to repair all radios faster, easier, save time and make more money. Here is your lowest-priced service data. Covers all years, from 1926-38 to 1958 models, in 18 volumes. Used by 174,000 shrewd servicemen. Most volumes only \$2 each, see coupon. Average volume 190 large pages, 8 1/2 x 11 inches. Quality printing, easy to use, manual-style binding. Amazing values. Be wise, use these manuals to get all needed diagrams, parts lists, alignment facts, and service hints, at the smallest cost. See your jobber or send no-risk trial coupon. →

TELEVISION SERVICING COURSE

Let this new course help you in TV servicing. Amazing bargain, complete only \$3, full price for all lessons. Giant in size, mammoth in scope, topics just like a \$200.00 correspondence course. Lessons on picture faults, circuits, adjustments, short-cuts, UHF, hints, alignment facts, antenna problems, troubleshooting, how to use test equipment, fault-finding hints, picture analysis. Special, only... **\$3**



Supreme Publications

Sold by All Leading Parts Jobbers

May, 1958

SUPREME TELEVISION SERIES

Here is your complete source of TV service data at lowest prices. **Supreme** manuals at only \$3 each are amazing bargains and defy competition. Each annual manual covers a whole year of models, using original factory material. Include giant double-spread circuits and blueprints, alignment procedure, waveforms, voltage charts, factory revisions, and helpful service hints. Select volumes from list below and send **no-risk** coupon.

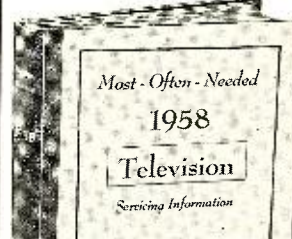

- 1958 TV Manual, \$3
- 1957 Early TV, \$3
- 1957 Late TV, \$3
- 1956 TV Manual, \$3
- 1955 Early TV, \$3
- 1955 Late TV, \$3
- 1954 TV Manual, \$3
- 1953 TV Manual, \$3
- 1952 TV Manual, \$3
- 1951 TV Manual, \$3
- 1950 TV Manual, \$3
- 1949 TV Manual, \$3
- 1948 TV Manual, \$3

NO-RISK TRIAL ORDER COUPON

SUPREME PUBLICATIONS, 1760 Balsam Rd., Highland Park, Ill.

- 1958 Radio Diagrams, \$2.50
- 1957 Radio Manual, \$2.50
- 1956 Radio Diagrams, \$2.50
- 1955 Radio Manual, only \$2

- 1954 These annual RADIO volumes specially priced at only **\$2.50** each...
- 1953
- 1952
- 1951
- 1950
- 1949

- 1948
- 1947
- 1946
- 1945
- 1944
- 1943
- 1942
- 1941
- 1940
- 1939
- 1926-1938 Manual, \$2.50
- Radio & TV Master Index, 25c

Rush today TV manuals checked below and Radio manuals at left. Satisfaction guaranteed.

- New 1958 Television Servicing Manual, only... \$3.**
- Additional 1957 TV, \$3.** **Early 1957 TV, \$3.**
- 1956 Television Manual, \$3.** **Early 1955 TV, \$3.**
- Additional 1955 TV, \$3.** **1954 TV Manual, \$3.**
- 1953 Television Manual, \$3.** **1952 TV, \$3.**
- 1951 Television Manual, \$3.** **1950 TV, \$3.**
- 1949 TV Manual, \$3.** **1948 TV Manual, \$3.**
- New Television Servicing Course, complete... \$3.**

- I am enclosing \$..... Send postpaid.
- Send C.O.D. I am enclosing \$..... deposit.

Name:

Address:

3 REASONS WHY THEY'RE THE BEST ON THE MARKET!

SPAULDING X-CB TV TOWERS

1. NO CONCRETE NECESSARY
2. COMPLETELY SELF-SUPPORTING
3. GO UP IN 90 MINUTES

No other TV antenna tower offers so much in the way of quality, appearance and easy installation as SPAULDING X-CB STRATO-TOWERS. Beaded channels, riveted construction and heavy galvanizing, plus exclusive cylinder base eliminate concrete and guy wires, assure fast, permanent erection. Insist on SPAULDING . . . be sure of all-ways better TV pictures!

U. S. Patent No. 2806360

No. X44CB (ILLUSTRATED)
40 FT. HIGH LIST **\$79.95**
OTHER MODELS FROM 8 FT. TO 64 FT.

HOW
TOWER
MOUNTS ON
CYLINDER
BASE



WRITE

today for complete literature and details on where to get Spaulding Strato-Towers for TV—Ham—Civil Defense—Industrial Communications.

SPAULDING PRODUCTS COMPANY

550 West Barner Street Frankfort, Indiana
IN CANADA: Delhi Metal Products Co., Delhi, Ontario

What's

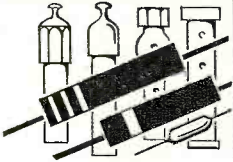

New in Radio

PHOTOCELL RELAY KIT

Lafayette Radio, 165-08 Liberty Ave., Jamaica 33, N. Y. has added a photocell electronic relay to its line of kits for the "do-it-yourself-er."

The new unit, KT-133, can be used in burglar alarm, door opener, light control, and counting applications. The

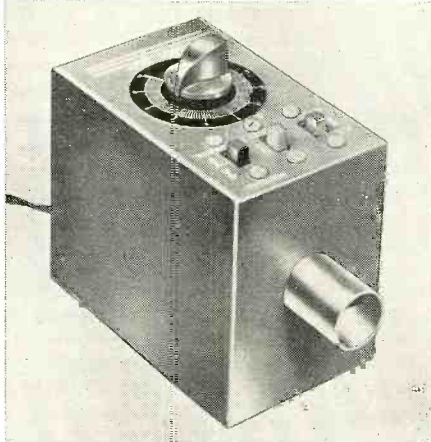

cadmium sulphide photocell is ultra-sensitive and requires no special high-intensity light source. It can be actuated by a flashlight at 250 feet. Provision is made for sensitivity adjustments as required by the application.

The controlled circuit operates on 117 volts a.c. with instructions for simple wiring changes to supply the external circuit with other desired voltages. The relay contacts are rated at 5 amps, permitting up to 500 watts external load on 117 volts a.c.

The kit comes complete with all parts, photocell, tube, chassis, silk-screened metal cabinet, and easy to follow instructions. The unit measures 3" x 4" x 5".

SSB TRANSMITTER

Collins Radio Company, Cedar Rapids, Iowa has announced the summer release of a new single-sideband transmitter, the 32A-1.

Among the features of this new unit are 175 p.e.p. input; coverage of the

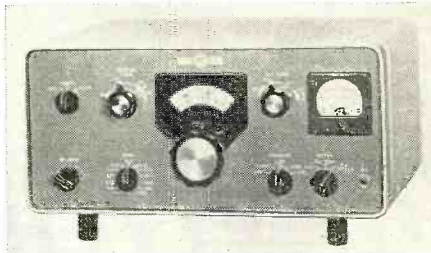

80, 40, 20, 15, 11, and 10 meter bands; upper-lower sidebands; break-in c.w.; r.f. feedback; mechanical filters; permeability tuned precision v.f.o.; etc. Optional accessories such as a phone

patch, directional wattmeter, and built-in antenna relay will be available.

The transmitter measures 6 $\frac{1}{16}$ " high by 14 $\frac{1}{2}$ " wide, by 11" deep. Power output is 100 watts.

Write the company for further details and delivery dates.

COLOR TV MONITOR

The Broadcast and TV Equipment Department of *Radio Corporation of America* has announced the availability of a new "pure-picture" 21" television monitor for color programming in broadcast and closed-circuit operations.

The monitor, Model TM-21, is engineered for the ultra-high quality, stability, and uniformity required in color broadcast and closed-circuit operations. The 21" monitor reproduces faithfully all information contained in a compatible color picture. It presents the scene exactly as the camera sees it and facilitates pinpointing elements of the over-all TV system which may need adjustment.

As a reference standard for evaluating the color fidelity of the complete broadcast system, the TM-21 monitor



provides precision checks of color registration, color balance, shading, deflection and transmission system transients, effects of pedestal adjustments, as well as camera deflection linearity, chroma level, and phase or hue adjustments.

NEW CBS RECEIVING TUBES

CBS-Hytron of Danvers, Mass. has just released six new receiving tubes; two hybrid auto radio tubes, two series-string tubes, a v.h.f. tuner tube, and a color-TV high-voltage rectifier.

The hybrid auto tubes, Types 12AL8 and 12DL8, operate directly from a 12.6-volt automotive battery system.

RADIO & TV NEWS

THE ALLSOLVER

TO ADD,
SUBTRACT,
FIND ROOTS,
POWERS, SIN, COS,
DIVIDE, MULTIPLY,
SOLVE TRIG AND ALGEBRA.

Now TRANSISTORIZED, with special dials to add several numbers at once, multiply as many as ten numbers at once by adding a few more parts! Based on the principle of Analog computers

Courses:
C14 Computer Master, 50 lessons plus projects. Diploma issued. \$22.50 down, then \$12.40 for six months.
C15 Electronics, radio, television, computers, telemetering and radar. \$22.50 down and then \$10.00 for five months. Ask for our new catalog.

EBE Inc., 1015 Atkin Ave., Salt Lake City 6, Utah
Send the ALLSOLVER encl. \$38.50 ppd. encl. \$22.50 down
Send course
Send free catalog

attach name and address

GET YOUR COMMERCIAL TICKET EASIER WITH...

Kaufman's
RADIO OPERATOR'S LICENSE Q AND A MANUAL

now available
6th EDITION
up to the minute

The BEST book for FCC License Preparation
Covers elements 1 thru 8.

The only book with complete discussion of answers to every technical question in the FCC Study Guide. Makes it very easy to answer multiple choice questions. Used by leading schools and industry. Only \$6.60 at jobbers, bookstores or direct from:

JOHN F. RIDER PUBLISHER, INC.
116 West 14th Street, New York 11 N. Y.

SCHEMATICS—CONVERSIONS FOR SURPLUS GEAR

NEW LIST DI! MANY ADDITIONS!

Send stamped, self addressed envelope for List D. Add 25¢ for chart explaining AN nomenclature. DO IT TODAY!

R. E. BOX 1220
GOODHEART BEVERLY HILLS, CAL.

a TERRIFIC BARGAIN in a

SOLA CONSTANT-VOLTAGE TRANSFORMER

Ends fluctuating line voltage!

Big Discount Off...

the factory price at a 1-input 2,000 VA unit! And here's another bonus! This Air Forces 2,000 VA overstock, Sola Cat. No. 30768, has 4 inputs! 80-125 V., 190-250 V., 60 cy. or 50 cy. Isolated secondary is constant 115.0 V. ± 1% from no-load to full-load of 17.4 amp. So, if you choose, use it as a 220:115 V. step-down. And slash \$97.50 off the factory 1-input price!

Brand new in original wood box. 4 cu. ft. Ship. wt. 254 lbs. F.O.B. Pasco, Wash. Only... **\$147.50**

THE M. R. COMPANY
P. O. Box 1220-A Beverly Hills, Calif.

ELECTRONICS

PREPARE FOR A GOOD JOB!
BROADCAST ENGINEER
RADIO SERVICING AUTOMATION

TELEVISION SERVICING
BLACK & WHITE—COLOR

APPROVED FOR VETERANS AND SURVIVORS OF VETERANS
BUILDING AIR CONDITIONED
SEND FOR FREE LITERATURE

BALTIMORE TECHNICAL INSTITUTE
1425 EUTAW PLACE, BALTIMORE 17, MD.

The Types 3AF4A and 4AU6 have 450 ma. heaters with warm-up control for series-string television. They are identical to their 6.3-volt counterparts except for heater characteristics.

The v.h.f. tuner tube, designated as the 6CY5, combines a high signal-to-noise ratio, transconductance, and input impedance to provide a desirable gain and bandwidth factor for better TV performance. The sixth tube, the 3B2, is primarily for use in color-TV receivers as a high-voltage flyback rectifier. It features a peak inverse plate voltage of 35 kv. and a minimum d.c. output of 1.1 ma.

ELECTRONIC CONTROL SYSTEM
D. W. Thomas Engineering Inc., 806 Robertson Blvd., Los Angeles 35, Calif. has recently introduced a new transistorized subminiature electronic control system for garage doors,

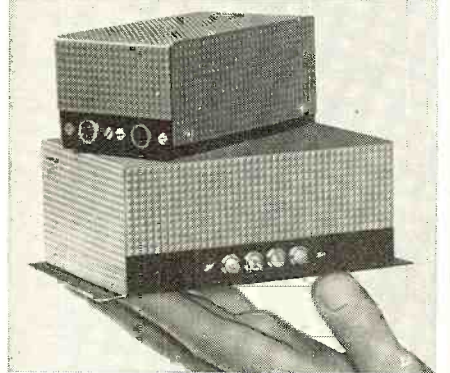

gates, freight car grain unloaders, blast furnace doors, and other applications requiring the control of electrical and electromechanical devices from remote locations.

Known as the "Ra-Trol", the new circuit consists of a crystal-controlled superheterodyne receiver and a channel-coded, r.f. modulated drift-free transmitter to eliminate interference with other services. The receiver is activated only by signals generated by its companion transmitter. Forty different operating channels are available. Normal control range is 100 feet.

CENTRALAB "TUBE-R-CAP"
Centralab of 900 E. Keefe Ave., Milwaukee 1, Wis. has introduced a new miniature feedthrough "Tube-R-Cap"

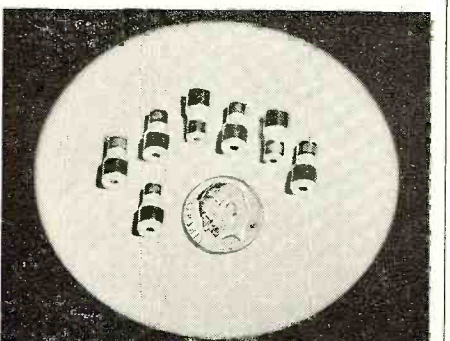

incorporating a resistor and capacitor in a single ceramic tube 7/16" long that mounts in a .190" hole. This new RC feedthrough is de-

TRANSISTOR RADIO REPAIRS NOW EASY!



with this
NEW *Howard W. Sams* BOOK
"SERVICING TRANSISTOR RADIOS"
COMPLETE ANALYSIS OF **70** POPULAR TRANSISTOR RADIO MODELS

includes new General Motors (Delco) Transistorized Auto-Portable Radio

Also Valuable Section—**"BASIC POINTERS ON SERVICING TRANSISTORIZED RADIOS"**...

COVERS LATEST MAKES AND MODELS

This book helps you earn big profits on Transistor Radio repairs—gives you complete, time-saving information—helps you become an expert on transistorized radios! Complete data on 70 latest models is based on actual lab analysis of each set. You get the famous Sams Standard Notation schematics—accurate, big, legible; full photo views of each chassis, with all components identified; complete alignment instructions; complete parts lists with full replacement data—everything you need to be successful in fast-growing transistorized radio servicing. Here's a "must" book for your bench. Order it now!

152 pages; 8 1/2 x 11" **\$295**
PRICE ONLY.....

SEE THIS BOOK AT YOUR SAMS DISTRIBUTOR OR MAIL COUPON

FREE TRIAL COUPON

Howard W. Sams & Co., Inc., Dept. 1-EE8
2201 E. 46th St., Indianapolis 5, Ind.

Send me Sams "Servicing Transistor Radios" for 10 days FREE examination. In 10 days I will pay for the book, plus few cents delivery cost, or return postpaid.

We pay delivery costs if you remit with this coupon; same return privilege.

Name _____
Address _____
City _____ Zone _____ State _____
(Outside U.S.A. priced slightly higher)

SIGMA 4F RELAY
 Sensitive 24 VAC or 6 VDC SPDT...\$1.49
 With Transformer for 110 VAC operation...\$1.89

POWER SUPPLY KIT BARGAIN
 Primary 115V, 60 Cy. Sec. 400-0-400V. @
 200 Ma. 6.3V. 1.5 Amp. 5V @ 4 Amp. Std.
 Mounting, plus 6 Hy. 200 Ma. choke
 and Two 10 Mfd. Oil Condensers...ea. \$7.50

STEPPING RELAY
 Resettable type. 3 deck 10 position
 with additional 1A and 1B \$895
 contact at reset position. Step-
 ping coil 24 VDC. ea.

6.3 FILAMENT TSMFRS.	24 V FILAMENT TRANSFORMER
20 Amp.....\$3.95	1/2 Amp......69¢
15 Amp.....2.95	10 Amp.....\$3.95
10 Amp.....2.19	
3 Amp.....1.89	
1 Amp.....1.19	

TRANSFORMERS
 115V Pri. 150V Sec.
 6.5 Amps.....\$4.95

AC BLOWERS
 115VAC 120 CFM \$9.95

OIL CONDENSER BARGAINS

1 Mfd 600 VDC \$.25	10 Mfd 1500 VDC \$3.75
2 Mfd 600 VDC .45	2 Mfd 2000 VAC 1.50
4 Mfd 600 VDC .75	3 Mfd 2000 VDC 2.75
10 Mfd 600 VDC 1.10	15 Mfd 1500 VDC 3.95
25 Mfd 600 VDC 3.40	2 Mfd 5000 VDC 8.75
20 Mfd 650 VDC 2.75	1 Mfd 3000 VDC 1.85
1 Mfd 1000 VDC .60	4 Mfd 4000 VDC 12.75
2 Mfd 1000 VDC .75	1 Mfd 5000 VDC 3.25
4 Mfd 1000 VDC 1.25	16 Mfd 2000 VDC 4.50
10 Mfd 1000 VDC 1.75	
4 Mfd 1500 VDC 1.75	

PANEL METERS

2" METERS	0-5 Ma..... 3.95
0-120 Ma RF with external Thermo. couple..... 3.95	0-25 Ma DC..... 3.95
0-300 VAC..... 3.95	0-50 Ma DC..... 3.95
	0-200 Ma DC..... 3.95
	0-150 VDC..... 3.95
	200-0-200 V. DC. 3.95
	0-1.5 Amps DC..... 2.95
3" METERS	0-15 DC KV 3" with shunt..... \$6.95
0-15 DC KV 3" with shunt..... \$6.95	0-3/2 KV with shunt..... \$6.95
0-3/2 KV with shunt..... \$6.95	2" Dual scale w/high and low/switch 0-150V. DC. 0-7 1/2V. DC..... \$3.95

115 V. 60 CYCLES SELSYNS
 High torque BRAND NEW in original wrappings. Made for Bendix Aviation. 2 for \$10.50.....Each

RELAYS
 110 V. A.C.-3 pole heavy duty duno. relay, 30 amp. contacts.....each \$4.39

RELAY
 GVDC P-B DPST 5 Amp Contact.....\$1.29

MICROAMMETER
 0-200 2". Mounted in Rubber case with cable.....Ea. \$2.95

MOSSMAN SWITCH
 Tel. type lever 12PDT.....Ea. \$2.95

G. E. RELAY CONTROL
 (Ideal for Model Controls, Etc.)
 Contains a sigma midget 8,000 ohm, relay (trips at less than 2 MA), high impedance choke, bi-metal strip, neon pilot and many useful parts. The sensitive relay alone is worth much more than the total low price of..... \$1.10 Each 10 for \$9.25

DYNAMIC MICROPHONE
 Made by ELECTRO-VOICE. 15 Ohm. Impedance...ea. \$3.95

SIGNAL CORPS EARPHONES
 Hi-Impedance Dual Headset, complete w/headband & Cord. Used -terrific Value \$1.79 Per Set 2 for \$3.25

ANTENNA RELAY
 12 Volt DC, DPDT plus extra SPST 10 amp contact. Low Loss ins...ea. \$1.39

SELENIUM RECTIFIERS
 30-36 VDC input, 24-28 Vac output, 5 Amps..... \$4.50 1/2 Amp..... \$1.19 150 Ma 110V... \$1.29

Min. Order \$3.00-25% with order F.O.B. New York 10 DAY GUAR. PRICE OF MDSE. ONLY

ADVANCE ELECTRONICS

6 WEST BROADWAY, NEW YORK 7, N. Y.
 Phone REctor 2-0270

Wholesale Only SELLING

Receivers, Transmitters, Radar, Special Purpose Tubes, Relays, Meters, Switches, Connectors, Rectifiers, Transformers, Motors & Generators, Wiring Cable, Instruments and All Electronic Components.

RADIO & ELECTRONIC SURPLUS
 14000 BRUSH STREET
 Detroit 3, Mich. TO 9-3403

signed primarily for antenna filter applications in TV tuners. It can also be used as a bypass unit in other medium to high frequency applications.

Catalogued as the 732, capacity is 400 μ fd., 1000 working volts and resistance is .3 to 1 megohms. Additional information is available from the manufacturer.

VECTOR "ZIP STRIPS"

Vector Electronic Company, 1100 Flower St., Glendale 1, Calif. has announced a new line of terminal strips featuring its versatile "Zip Terminal" which is designed for rapidity and ease in wiring while occupying a minimum amount of space.

The new terminals speed up and simplify component wiring by providing two pairs of toothed gripper-jaws at right angles to each other to firmly retain wires as they are pushed in. An additional feature provides for self-strapping of adjacent terminals, accomplished by pushing down the smaller gripper-jaws over an adjacent tongue. A through-hole offset from the main gripper-jaw slot permits riser wires or other component wires to go through.

"Zip Strips" are supplied either with or without mounting brackets in a variety of sizes.

B-T "ULTRAVERTER"

Blonder-Tongue Laboratories, Inc., 9-25 Alling St., Newark 2, N. J. is now offering a redesigned version of its u.h.f. converter as the Model BTU-2R "Ultraverter."

Designed to meet the new FCC standards, the unit adds all u.h.f. channels from 14 through 83 to stand-

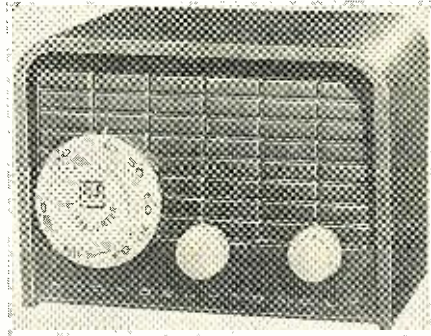

ard v.h.f. receivers. The circuit features a dual-speed channel selector, double-tuned input, low-noise triode amplification, and precise 300-ohm match.

Housed in a modern two-tone plastic cabinet, the unit uses two tubes and operates from 117-volt, 60-cycle power lines. The device measures 6 3/4" x 5" x 4 3/4" and weighs 4 pounds. It carries UL approval.

Additional details on the "Ultraverter" will be supplied upon letterhead request to the manufacturer.

TELEVISION ANALYST

B&K Manufacturing Co., 3726 N. Southport Ave., Chicago 13, Ill. has just announced the availability of its new Model 1075 signal-injection, direct-viewing television analyst for

Now-see how to save hundreds of dollars, get more fun out of High Fidelity!

New 1958 EDITION HI-FI GUIDE and YEARBOOK

★ 164 Pages!
 ★ Hundreds of Pictures!

ACTUALLY 3 BOOKS IN 1

1. Improving Your Hi-Fi. How to use tone controls. How crossovers work. Ways to boost speaker performance. Why you need loudness controls, how to add them. How to add extra speakers to your rig. How to add a spotlight with presence control... tricks of accenting the middle sound frequencies. Effects of variable damping in amplifiers. How to check your phonograph's pickup and keep it working at peak efficiency. Ways to check a stylus.

2. Tape Techniques. How to get the most out of tape. How to keep tape in top shape. How to tape programs directly off the air... step-by-step instructions and pictures. Expert hints and shortcuts on making good tape recordings. How to check a tape recording head to ascertain alignment. Complete guide to tape splicing for interesting effects.

3. Getting Into Stereo. What stereo is. Latest advances. What the different stereo systems are. What stereo equipment is available. How to add stereo to your present rig. Merits and drawbacks of different systems. What they cost. Tricks of the trade.

On sale now everywhere Only \$1

quick, direct, and complete TV troubleshooting.

With the new unit, point-to-point signal injection and test pattern reproduction, any service technician can

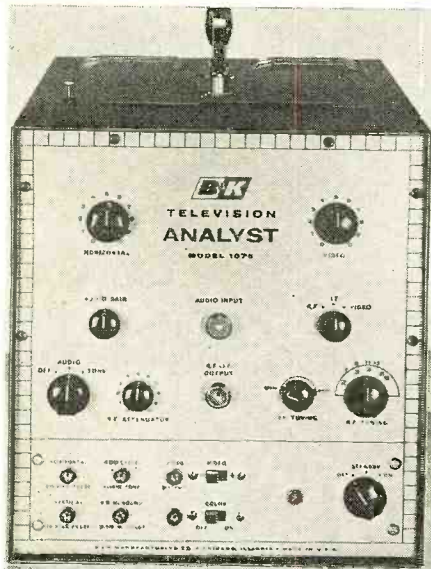

easily troubleshoot and signal-trace any stage throughout the r.f., i.f., video, audio, and sweep sections of black-and-white and color TV receivers. The instrument quickly isolates and diagnoses TV troubles including intermittents. By use of the generated test pattern, it is possible to see the condition directly on the picture tube screen of the TV set itself. No external scope is needed.

Bulletin TAD-18, containing complete specifications and price, is available from the manufacturer on request.

FREQUENCY CHANGER

Carter Motor Company, 2793A W. George St., Chicago 18, Ill. has added the "Change-A-Cycle" frequency changer to its line of instruments for field use.

The new unit is said to operate on a principle entirely different from con-



ventional motor-generator devices. The a.c. input is rectified to d.c. and then fed to a special d.c.-to-a.c. converter, having a 60-cycle or 50-cycle output, as specified. A rheostat provides a $\pm 10\%$ adjustment for cycle variation.

The design requires no transformer. The unit will work on any input fre-

May, 1958



Leo I. Meyerson
WØGFK

Leo Says: "OF COURSE!
Your Best Buy is from

ON THIS NEW

hallicrafters SX-101 MARK III



\$39.50 Down

\$395 Net Only **\$22⁷²** per mo.

Utmost mechanical and electrical stability. Complete coverage of 7 amateur bands: 160, 80, 40, 20, 15, 11 and 10 meters. Exclusive crystal-controlled upper/lower sideband selection. S-meter functions with AVC off/on. Tee-notch filter. Built-in crystal calibrator. Antenna trimmer, dual conversion, full gear drive, five steps of selectivity from 500-5,000 cycles, band in use illuminated.

Send for Complete Information Today!



Please send me Free Catalog . . . and complete info on Hallicrafters SX-101. R 5/7

NAME: _____

ADDRESS: _____

CITY & STATE: _____

World Radio!

- ★ **EASY PAYMENT**
We finance our own paper, offering a really easy payment plan. You can be working your new equipment from World Radio while you pay. Only simple credit information is required.
- ★ **ONLY 10% DOWN**
On any item over \$15, you pay just one tenth down. World Radio does everything in its power to make it easy for the ham to buy. Why not try us?
- ★ **COMPLETE STOCKS**
The foremost lines of major manufacturers are stocked here at World Radio. No waiting for factory shipment; no tie-up in getting your order.
- ★ **TOP TRADE-INS**
Our reconditioned list is the bible of the industry. This means that hundreds of hams trade at World Radio, proving our offer of the best trades around the country. Ask for a quote.
- ★ **FAST SERVICE**
Our location in the center of the U.S. our large processing staff and shipping department all mean prompt, same-day service to you. You get what you want, at once!
- ★ **PERSONAL ATTENTION**
World Radio is geared for individual service and counsel. No cold organization here, but top ham personnel to work with you when you ask for information or merchandise.

FREE 1958 Catalog

200 pages, hundreds of illustrations, 15,000 top value items write for yours, today!



FREE! 360 pages of the
Newest in

ELECTRONICS
HIGH FIDELITY • RADIO • TV



NEWARK'S

NEW **CATALOG** 1958

Offers you a fast, efficient, dependable way of selecting the finest components in the field at the lowest prices.

NEWARK
ELECTRIC COMPANY

Write Dept. R-5

223 W. Madison St. • Chicago 6, Illinois
4736 W. Century Blvd. • Inglewood, Calif.

LEARN

Television
RADIO-COLOR-TV
Electricity
ELECTRONICS
IN THE GREAT SHOPS OF **COYNE**

TRAIN QUICKLY! OLDEST, BEST EQUIPPED SCHOOL of ITS KIND in U.S.

Veterans and Non-Veterans—Get practical training in top opportunity fields. Prepare now for a better job and a real future. Advanced education or previous experience not needed. Employment service to graduates.

Enroll NOW—Pay Later

Finance Plan and Easy Payment Plan. Also Part Time Employment help for students. *Training in Refrigeration and Electric Appliances can be included.*

FREE BOOK Clip coupon for Big Free Illustrated Book. No obligation and No Salesman Will Call. Act NOW.

B. W. Cooke, Jr., President
COYNE
ELECTRICAL SCHOOL
OPERATED NOT FOR PROFIT
Established 1899
500 S. Paulina, Chicago
Dept. 58-6C

B. W. COOKE, Jr., Pres.
COYNE Electrical School
500 S. Paulina St., Chicago 12, Ill. Dept. 58-6C

Send FREE BOOK and full details on:

- TELEVISION-RADIO
- ELECTRICITY-ELECTRONICS

NAME: _____

ADDRESS: _____

CITY: _____ STATE: _____

STAN-BURN

CATHODE RAY TUBE SPECIALS
ONE YEAR GUARANTEE

G.E.	Type	STAN	G.E.	Type	STAN
\$15.80	.10BP4	\$10.00	\$24.75	.17LP4	\$18.00
19.10	.12CP4A	13.95	37.00	.19AP4A	24.00
30.25	.12OP4	11.50	25.30	.20CP4B	18.95
20.75	.14CP4	13.75	36.00	.21AP4	25.00
33.75	.15DP4	14.50	29.75	.21EP4A	20.25
34.85	.16CP4	15.75	34.85	.21EP4B	24.00
32.20	.16DP4A	15.25	30.90	.21FP4	21.15
33.75	.16GP4	18.75	37.00	.21MP4	26.25
23.50	.16KP4	16.25	29.75	.21YP4	24.00
28.40	.16KP4A*	18.75	34.85	.21YP4A*	25.00
31.50	.16LP4A	16.25	28.30	.21ZP4	21.00
31.50	.16WP4	16.25	100.00	.24AP4	56.00
25.00	.20BP4	15.75			
28.40	.17BP4B*	18.75	48.40	.24BP4*	39.00
30.75	.17CP4	20.50	50.00	.24DP4A*	39.00
33.90	.17GP4	21.50			

*ALUMINIZED—INQUIRE FOR ANY TUBE TYPE NOT LISTED. STAN-BURN CRT TUBES RCA LICENSED—MFD. BY LINGOLT. All orders of 6 or more STAN-BURN CRT are subject to additional 10% discount. PRICES SUBJECT TO CHANGE WITHOUT NOTICE.

WHY PAY MORE? HI-FI COMPONENTS • KITS • RECORD PLAYERS • TAPE RECORDERS • TUNERS • AMPLIFIERS • SPEAKERS • ELECTRONIC PARTS & TUBES • Etc.

Top brand nationally advertised merchandise in this and other Radio & TV makes is yours at low, low cost. Send us your list. Give Mfr's name and Model No. of item. Write for '58 catalogs to Dept. RTV-5 today.

GENERAL ELECTRIC RECEIVING TUBES

Brand New—1 Year Guarantee—Boxed

OZ4	.83	6K6GT	1.13	12SA7	1.45
1B3C	1.38	6SW7GT	1.25	12X7	1.33
5U4GA	.95	6Y6GT	1.03	12X7	1.18
6AG5	1.25	6W4GT	1.15	35W4	.68
6AU6	1.00	12AU7	1.18	35Z5GT	.90
6BD6GA	1.28	12BA6	1.03	6X4	1.03
6BG6GA	3.10	12BE6	1.03	50L6GT	1.15

ADDITIONAL 10% DISCOUNT IN LOTS OF 10 ASSORTED! WRITE FOR COMPLETE PRICE LIST

SAVE UP TO \$100 A YEAR ON TV REPAIRS
Amazing new book "How To Repair Your Own TV Set" gives you everything you have to know to spot TV trouble. Shows how to fix it properly. Everything in easy-to-understand language and step-by-step diagrams. Latest up-to-date information on tube changes, antennas, tube location charts, trouble shooting guides, etc., plus list of tube types and prices. Only \$1.00 plus 10¢ for postage.

HI-FI DIAMOND NEEDLES—1 Yr. Guar.
Diamond needles reduce record wear and needle noise thus retaining full frequency response. Diamond needles of your records for a longer period of time.
SINGLE DIAMOND needle.....\$7.95
DIAMOND SAPP dual needle.....8.95
Shipment PPD. (Specify cartridge make)

RECORD CHANGERS

- COLLARO TC-340 4 speed changer...\$36.75
- COLLARO RC-440 4 speed changer... 40.67
- COLLARO TC-540 4 speed changer... 45.57
- GARRARD RC-88 4 speed changer... 53.41
- GARRARD RC-98 4 speed changer... 66.15
- FREE wood mounting base, record wiping cloth and 45 RPM spindle with all orders for Collaro and Garrard changers, with this ad.
- VM 4 SPEED HI-FI CHANGER—Model 1210 with Ronette or Astatic flip-over cartridge\$22.95
- MONARCH Model UABU 4 SPEED AUTO. INTERMIX CHANGER less cartridge \$19.85
- WECOR 4 SPEED CHANGER with turn-over cartridge\$23.95
- RONETTE (phono fluid) cartridge flip-over type\$2.98
- SONOTONE cartridge, flip-over.....\$2.98
- 45 RPM SPINDLE for V.M. or Monarch...\$1.98
- WOOD MOUNTING BASE for V.M. or Monarch\$3.95
- MOUNTING BOARD unfinished for V.M. or Monarch\$1.50
- NEW GENERAL ELECTRIC HI-FI VARIABLE RELUCTANCE CARTRIDGE. Replaces discontinued RPX050 type. Full range reproduction 20-20,000 cycles. Four gram tracking force for minimum record and stylus wear.
- 4G050—Dual Sapphire needles.....\$8.77
- 4G052—Diamond, Sapphire needles...\$18.99

KITS! We stock the following manufacturers complete line of kits—see Advertisers Index for reference pages.
EICO QUALITY CABINETS
DYNA BOGERS ELECTRO-VOICE
ARKAY GROMMES TECHMASTER
All domestic orders will be shipped prepaid. Send us your list. Order by Mfr. and Model No. of item.

\$20 WORTH OF ELECTRONIC PARTS IN GRAB-BAG consisting of: Porcelain sockets, coils, speaker, trans resis. cond. ONLY.....\$1.98 (plus 50¢ postage)

YOU NAME IT—WE HAVE IT
Complete line of T.V. & Radio receiving tubes, coils, transf., controls, and accessories. Minimum Order—DEALER DISCOUNTS! Thousands of satisfied Hi-Fi enthusiasts and dealers will vouch that STAN-BURN GIVES THE BEST DEAL POSSIBLE!

EXPORT INQUIRIES AND OFFERS INVITED
Terms: 20% with order. Balance C.O.D. All prices F.O.B. NEW YORK Warehouse.
Write for our latest price list and Hi-Fi Catalog RTV-5. All Prices Subject to Change Without Notice.

STAN-BURN RADIO and ELECTRONICS CO.
558 CONEY ISLAND AVE. • B'KLYN 18, N. Y.

quency and output capacities range from 40 to 2000 watts a.c. The changer is available for single-phase or three-phase input.

Ray Simon, chief engineer of the company, will supply additional information to those writing him in care of the firm.

TRANSISTOR TESTER

Precision Apparatus Company, Inc., Glendale, N. Y. is now offering a portable transistor and crystal diode tester as its Model 960.

The tester gives comprehensive tests for I_{cbo} , gain, leakage, shorts, etc. on low-, medium-, and high-power

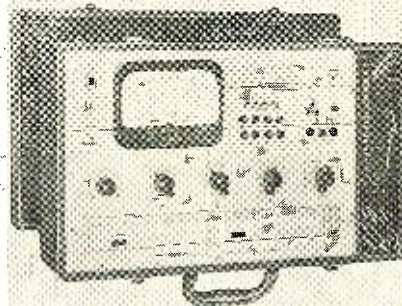

transistors of both the p-n-p and n-p-n types, as well as the new tetrode transistors.

The Model 960 is a self-contained, a.c.-operated unit. No batteries are used or required. It has an etched, three-color, brushed aluminum, die-drawn panel, and comes in a portable carrying case which measures 18" x 10½" x 6¼".

SPEAKER EXTENSION

Vidaire Electronics Mfg. Corp., Lynbrook, N. Y. is now offering an inexpensive extension speaker designed to be used with TV or radio receivers.

The Model ES-200 permits receiver volume to be adjusted from any point up to 20 feet from the set. The remote

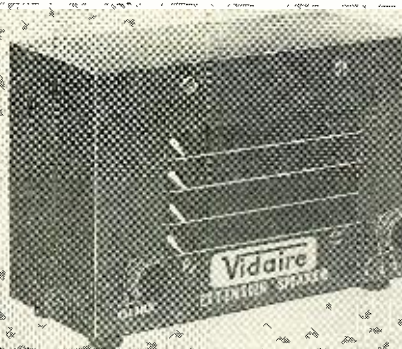

unit permits either the remote or set speaker to be switched or both may be on at once. A volume control for adjusting the sound level is included.

The extension unit is housed in a mahogany finished cabinet which will blend in with most interiors. A data sheet on this item is available.

"SOLDER-MATIC" IRON

Atlas Manufacturing Co., Inc., 1126 S. Decatur St., Montgomery, Alabama has begun distribution of a new type of soldering tool which is being mar-

A....Always
B....Buy
C....Columbia

BC-191 TRANSMITTER
12 V. Input power: 700 watts. Freq.: 1500 to 12,500 kc. Self-contained modulation. Can be used for CW or phone. Excellent, like new. ONLY.....\$14.95

BC-221 FREQUENCY METER
20-20,000 kc. Army version of Navy LM Freq. Meter. Complete. Excellent. \$79.50 checked out.....

FIXED OR MOBILE RBM COMMUNICATIONS RECEIVER
RBM Model No. 1: 200-2,000 kc. 11-tube superhet. For CW, MCW or phone. Brand new condition.....\$29.95
RBM Model No. 2: Two to 20 MGS. 11-tube superhet. For CW, MCW or phone. Brand new condition.....\$49.95
AC POWER SUPPLY: For either above receiver. Brand new. Now only \$14.95
12VDC POWER SUPPLY: For either above receiver. Brand new.....\$9.95

AN/URC-4 UHF-VHF HANDY-TALKIE
Has preset dual fixed frequencies of 121.5 and 243 MC. Easily converted for 2 meter or citizens band. Self-contained whip-type dipole antenna. Excel. cond. with tubes.....\$39.50

BC-1335 RECEIVER-TRANSMITTER
27-38 MC. 120-channel FM. This is an 18-tube, small size, crystal controlled unit! Perfect for mobile installation. Has 6 or 12 V. SELF-CONTAINED power supply. Brand new. Complete with all tubes and vibrator. ONLY SPARE VIBRATOR for this unit. New. \$19.95 \$11.25

BC-683 RECEIVER
27-38.9 MC. 10 tubes. Continuous and push-button tuning on 10 pre-set channels. Complete with 10 tubes, speaker, and touch control circuit. R.F. gain. Like new.....\$14.95

BC-603 RECEIVER. Same as above except freq. is 20-28.5 MC. Like new.....\$5.95

POWER SUPPLIES
110 VAC. 60 cycles power supply for EITHER above BC-683 or BC-603 Receiver. New mfr. May be plugged into dynamo receptacle on receiver. RECEIVER DOES NOT REQUIRE ANY CONVERSION! Power supply interchangeable with dynamotor for 12 V. use.....\$11.95
AVAILABLE in kit form with instructions \$7.95
All Orders FOB Los Angeles. 25% deposit required. All items subject to prior sale. NOTE: MINIMUM ORDER \$3.00. WRITE TO DEPT. R.

Columbia ELECTRONICS
2251 W. WASHINGTON BLVD.
LOS ANGELES 18, CALIFORNIA

CATALOG OF Professional Quality Kits
"DIRECT FROM FACTORY"

FREE TRANSVISION SPLIT/KITS

- TV KITS
- INSTRUMENT KITS
- HI-FI KITS, SPEAKERS
- HI-FI CABINETS (Largest Selection)
- Electronic PHOTOFLASH Kits

PAY AS YOU WIRE with Transvision "SPLIT-KITS." A few dollars gets you started. Each KIT is split into a few packages. You can order one at a time as you wire.

Also RECORDS at BIGGEST DISCOUNT!
RCA - CBS - All Labels

TRANSVISION, INC., New Rochelle, N. Y.
Rush FREE Catalog of KITS, HI-FI Equipment, Cabinets, Records, etc.

Name _____
Address _____
City _____ State _____

keted as the "Solder-Matic Electric Iron".

The iron weighs only 6½ ounces and feeds the solder from a spool through a guide tube to the tip of the iron in

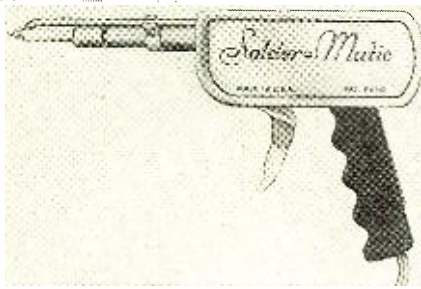

response to a trigger feed, leaving the operator's other hand free to hold work, thereby speeding soldering operations and improving the quality of joints.

The iron will be handled through hardware stores, electronic suppliers, and hobby shops. A catalogue sheet describing this new product is available without charge from the manufacturer.

A.C. V.T.V.M.

The Electron Tube Division of Radio Corporation of America, Harrison, N. J. has added a new high-sensitivity, alternating current vacuum-tube voltmeter to its line of test equipment for service applications.

The WV-74A can be used in measuring a.c. voltages from .01 volt to 100 volts and for decibel measurements from -40 to +40 db. The voltmeter is also useful as a wide-range audio pre-amplifier, having approximately 38 db maximum gain. Frequency range on all measurement and amplifier functions is from 20 to 500,000 cycles-per-second.

The instrument is designed for high-fidelity, broadcast, design and development, production, and servicing applications. It is housed in a die-cast aluminum case finished in durable blue-gray enamel. The voltmeter measures 7" x 6½" x 3¼" and weighs 6 pounds.

NUCLEAR TECHNOLOGY COURSE

CAPITOL Radio Engineering Institute of Washington, D. C. has set up a subsidiary, CREI Atomics, which will offer the nation's first advanced home-study course in nuclear engineering technology.

Scheduled to begin this fall, the new course will be designed to fill predicted needs for nuclear engineering technicians and other engineering personnel. The level of the course has been set for engineering and technical personnel in industry, government, and military services who plan to go into the field of atomic energy and its related applications.

The curriculum, which has been under development for a year, will be under the direction of Charles De Vore, formerly assistant technical information director of the U. S. Naval Research Laboratory.

WE TRADE HIGHER!

IT'S EASY TO DO BUSINESS WITH WALTER ASHE!

1. Just tell us what factory-built gear (made since 1945) you have to trade, and what new gear you wish to purchase. You'll get our top dollar quote by return mail.

2. When the deal is made, you ship your equipment to us by prepaid express or, if express is not available, by prepaid truck. We check it at once and, in most cases, your new gear is on its way to you within 24 hours after we receive your trade-in.

SEND FOR OUR BIG FREE 1958 CATALOG

144 PAGES
THE
"TREASURE CHEST"
OF VALUES

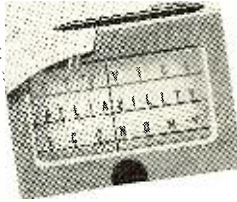

SPARKY SAYS

HEY! LOOK!
HOW ABOUT THIS?



WANT RECONDITIONED GEAR AT LOW COST? SEE WALTER ASHE!

WRITE FOR FULL DETAILS ABOUT OUR TIME PAYMENT PLAN

All prices f. o. b. St. Louis



WALTER ASHE RADIO COMPANY
1125 Pine Street, St. Louis, Mo.

OUR 36TH YEAR

Rush "Surprise" Trade-In Offer on my.....
for.....
(show make and model number of new equipment desired)

Send new FREE 1958 Walter Ashe catalog. RN-5-58.

Name.....
Address.....
City..... Zone..... State.....

AN/APN-9 LORAN Rec. Inc. Long
range navigation unit, 12 or 24
Volt Inst. New, complete. \$195.00

RT-18/ARC-1 VHF 10 Channel Crystal Controlled
Transceiver w/tube and Channel
Dynamotor. Exc. \$139.50

LM FREQUENCY METER

Heterodyne crystal calibrated, modulated, 125 KC
to 20,000 KC. Excellent, less calibration
book. \$24.95

J38 High Speed Telegraph Key with on and off
switch, adjustable spring tension and adjustable
spacing, mounted on bakelite base. Brand
New \$1.69

BC-659 FM Receiver-transmitter, xtal controlled,
two channels, freq. range 27-38.9. 9 Mc. 13 tubes,
built-in speaker, dual meter for testing
filament and plate circuits. Exc. \$6.95

BC 620—Same as above except less
speaker and 20 to 27 Mc. \$4.95

BC 683. Ten Channel Push-button or continuous
tuning FM RECEIVER 27 to 39 Mc complete
w/tubes, speaker, squelch circuit. Exc. \$19.95

BC 603. Same as above except to 20 to 27
Mc. \$6.95
12 Volt Dynamotor for above receivers. Exc. \$2.95 ea.

I-208 SIGNAL GENERATOR. A standard of
voltage freq. and freq. deviation for the testing,
alignment, calibration and sensitivity measure-
ment of FM receivers. Freq. range 1.9 to 4.5 Mc.
and 19 to 45 Mc. Operates from either 12 VDC or
110 VAC. Govt. acq. cost, \$1800.00. Exc. \$59.50

HS-30 HEADSETS—Low impedance hearing aid size,
w/headband, rubber insert and Y cord.
Like New Only \$.89
10 for \$8.00

BC453 COMMAND REC. 190 Kc to 550 Kc. Exc. \$12.95

WRITE FOR NEW BULLETIN
25% Deposit required with orders

R W ELECTRONICS

Dept. N

2430 So. Michigan Ave., Chicago 16, Ill.

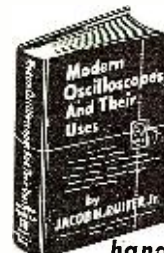

GET MORE WORK OUT OF YOUR OSCILLOSCOPE

Learn to service ANY radio or TV faster... with the handiest instrument of all!

Here, in a greatly enlarged edition, is THE book that really shows you how to use oscilloscopes!

Clearly as A-B-C, MODERN OSCILLOSCOPES AND THEIR USES tells you exactly when, where and how. You learn to locate either AM or FM radio or television troubles in a jiffy. Even tough realignment jobs are made easy. No involved mathematics! Every detail is clearly explained—from making connections to adjusting circuit components and setting the oscilloscope controls. And you learn to analyze patterns fast and RIGHT!

ENLARGED 2nd EDITION!

Includes Color TV 'Scope Data

Includes latest data on use of 'scopes in color TV, industrial electronics, teaching... even in atomic energy work. Over 400 pages and over 400 clear pictures. Dozens of pattern photos make things doubly clear... even for beginners!

PRACTICE 10 DAYS FREE!

Dept. RN-58, RINEHART & CO., Inc.
232 Madison Ave., New York 16, N. Y.

Send new 2nd edition of MODERN OSCILLOSCOPES AND THEIR USES for 10-day examination. If I like book, I will then send \$6.50 (plus postage) in full payment, or return book postpaid and owe you nothing. (SAVE! Send \$6.50 with order and we pay postage. Same return privilege with money refunded.)

Name.....
Address.....
City, Zone, State.....
Outside U.S.A.—Price \$7.00, cash with order only. Money back if you return book in 10 days.

QUARTZ CUT QUARTZ FOR EVERY SERVICE

All crystals made from Grade "A" imported quartz—ground and etched to exact frequencies. Unconditionally guaranteed! Supplied in:



FT-243 holders. Pin spacing 1/2". Pin diameter .093.

HC/6U metal sealed holders. Pin spacing .486". Pin diameter .050 or .093.

DC-34 holders. Pin spacing 3/4". Pin diameter .125.

MC-7 holders. Pin spacing 3/4". Pin diameter .125.

FT-171 holders. Pin spacing 3/4". Banana pins.

MADE TO ORDER CRYSTALS

1001KC to 2500KC:
.01% Tolerance. \$1.75 .005% Tolerance. \$2.50
2501KC to 9000KC:
.01% Tolerance. \$1.50 .005% Tolerance. \$2.50
Specify holder wanted.

3500 KC hermetically sealed frequency marker crystal .005% tolerance fits octal tube socket. **\$1.00**

ANY AMATEUR BAND CRYSTAL .05% Tolerance
NOVICE BAND CRYSTALS
80 meters 3701-3749KC
40 meters 7152-7198KC
15 meters 7034-7082KC
99c each

6 METER TECHNICIAN BAND CRYSTALS
8335KC-8550KC within 1KC—
each **99c**
Exact Frequency .01%—\$1.50 each.

ASK YOUR LOCAL PARTS DISTRIBUTOR FOR TEXAS CRYSTALS. LOOK FOR YELLOW & RED DISPLAY BOARD.

SEALED OVERTONE CRYSTALS supplied in metal HC/6U holders—pin spacing .486, diameter .050.
10 to 30 MC .005 tolerance \$3.85 ea.
30 to 54 MC .005 tolerance \$4.10 ea.
55 to 75 MC .005 tolerance \$4.25 ea.

FUNDAMENTAL FREQ. SEALED CRYSTALS
In HC/6U holders from 1400KC-10,000KC any frequency .005 tolerance \$3.50 ea.

STOCK OVERTONE CRYSTALS in FT-243 holders \$1.00. Frequencies listed in megacycles:
15.01 16.7 17.15 18.225
15.11 16.8 17.16 18.325
16.335 16.9 18.025 18.475
16.435 17.0 18.125 18.925

MARINE FREQUENCY CRYSTALS
All marine frequencies from 2000-3200KC
.005 tolerance \$2.50
(Supplied in either FT-243, MC-7, or FT-171 holders.)

RADIO CONTROL CRYSTALS
27.225 MC sealed crystals (1/2" pin spacing) specify pin diameter .093 or .050) \$2.50 ea.

Stock crystals in FT-243 holders from 5675KC to 8650KC in 25KC steps 50¢

FT-241 lattice crystals in all frequencies from 370KC to 540KC (All except 455KC and 500KC.) 50¢

Matched pairs ±15 cycles \$2.50 per pair.

200KC Crystals . . . \$2.00 100KC Frequency
455KC Crystals . . . \$1.00 Standard Crystals \$4.50
500KC Crystals . . . \$1.00
1000KC Frequency Standard Crystals . . . \$3.50
Dual Socket for FT-243 Crystals . . . \$ 15
Ceramic socket HC/6U Crystals . . . \$ 15

(Add 5¢ per crystal for postage and handling.)
WRITE FOR CATALOG AND QUANTITY PRICES.

Texas Crystals

The Biggest Buy in the U.S.

853B W. GRAND AVENUE RIVER GROVE, ILL.
ALL PHONES—GLADSTONE 3-3555

Terms: All items subject to prior sale and change of price without notice. All crystal orders MUST be accompanied by check, cash or M.O. WITH PAYMENT IN FULL. NO C.O.D.s. Postpaid shipments made in U.S. and possessions only. Add 5¢ per crystal for postage and handling charge.



EIA STANDARDS

The Engineering Department of Electronic Industries Association (formerly RETMA), Room 650, 11 W. 42nd St., New York 36, N. Y. has issued six new standards of interest to the industry.

The new publications are RS-170 covering electrical performance standards of monochrome studio facilities (price \$1.10); RS-198 on ceramic dielectric capacitors (80 cents); recommended standards for export receivers, RS-201 (25 cents); RS-154-A on polarized dry electrolytic capacitors for general use (\$1.10); RS-199 covering solid dielectric transmission lines (\$1.20); and RS-202 on recommended practice for the preparation of outline drawings of electron tubes and bases (\$1.20).

Any or all of these standards may be ordered from the Association. Payment should accompany all orders.

CERAMIC CATALOGUE

Centralab, a division of Globe-Union Inc., 900 E. Keefe Ave., Milwaukee 1, Wisc. has issued a new 16-page, 2-color "Ceramic Catalogue" which highlights High Alumina bodies in addition to Steatite, Cordierite, and Zirconite ceramics.

Included in the publication are special sections on standard extrusions, ceramic properties and specifications, plus a clear-cut method for ordering ceramic pieces. Requests for this catalogue should be addressed to Gerry Klein in care of the company.

PICKING CANNON PLUGS

Cannon Electric Company, 3208 Humboldt St., Los Angeles 31, Calif. has issued a 40-page plug guide designed to facilitate the rapid selection of the correct component.

The guide provides an orientation to the 53,000 connectors manufactured by the company. A check list for selection includes important considerations such as size, number and style of contacts, mounting space, coupling methods, insulation, and environmental conditions.

The publication also shows photographs of representative connectors, gives basic information on application, and indicates specific catalogues to order for complete data on each series of connectors.

RCA SCHOOL EQUIPMENT

Radio Corporation of America, Educational Services, Dept. 57, Camden 2, N. J. has compiled a booklet which describes the firm's line of electronic equipment of particular interest to the educational field.

Included in this 16-page bulletin are details on sound systems, various types of audio equipment, tape recorders, "Victrolas," radio and TV sets, closed-circuit TV equipment, electron microscopes, test equipment, tubes, records, etc. Each unit is pictured and described in terms of its usefulness to educational institutions.

Educators and those concerned with installations of school equipment are invited to write for a copy of this new publication.

ELECTRONIC CHEMICALS

General Cement Mfg. Co., 400 S. Wyman St., Rockford, Ill. has just issued a 28-page technical bulletin covering the use of electronic chemicals.

The new booklet discusses such chemicals as oxide cleaners, cements, resin sprays, varnishes, etc. A brief description of each product in the company's line is given, then the technical specifications and other information is presented.

Entitled "Electronic Chemicals," the new book is available at a cost of \$1.00 a copy through parts jobbers.

SUPREME BROCHURE

Supreme Publications, 1760 Balsam Road, Highland Park, Ill. is offering without charge a four-page brochure describing its newly published "1958 TV Manual."

A description of earlier television volumes and seventeen radio service manuals issued by the company is also included. Write the publisher direct for a copy of this brochure.

PISTON CAPACITOR DATA

JFD Electronics Corp., 6101 Sixteenth Ave., Brooklyn 4, N. Y. has just issued two new data sheets covering its piston capacitors.

Bulletins Nos. 205 and 206 furnish comprehensive performance characteristics and electrical and physical data on a number of the new panel mount quartz and glass dielectric trimmers.

These new data sheets are punched to fit the company's trimmer reference file folder.

DECADE BOX BULLETIN

Claroostat Mfg. Co., Inc., Dover, N. H. has included details on a unique power resistor decade box in a four-page bulletin which it is offering free on request.

The instrument itself will provide a power resistor of any known value from 1 ohm to 999,999 ohms, merely by twisting the six dial knobs. Or, if

BOGEN for P.A.

33 WATT AMPLIFIER
Complete with tubes and cage!

Reg. Price \$107.50



OLSON PRICE
\$64.50

The Ultimate in the CHALLENGER LINE

Stock No. AM-1

This new Bogen Amplifier will deliver tremendous volume for big auditoriums or outdoor gatherings. Can be used with any number of speakers. Equipped with five controls. Has two microphone plus one phono input, all of them can be mixed. Inverse feedback circuit. Peak output 36 watts.
Gain: Microphones 130 db., phono 83 db. Response 30-15,000 cps. Seven tubes, push-pull 6L6GB Beam Power Output. Size 14 1/2 x 9 1/2 x 8 3/4. Operates on 115 volts AC, 60 cy. Shipping wt. 27 lbs. Can be used with any high impedance microphone and any type speakers.



RCA PORTABLE SPEAKERS

Heavy duty luggage type case, finished in attractive gray leatherette covering. Complete with two heavy duty RCA 12" Public Address speakers with 8.8 oz. Alnico V magnets. Each speaker equipped with 25 foot cable and plug. For use with Bogen or any other amplifier. Case divides into two parts so speakers can be placed anywhere. Equipped with internal straps to hold amplifier. 8 ohm impedance. Overall size 11 1/4 x 24 3/4 x 18 1/4. Shipping wt. 20 lbs.

OLSON PRICE
\$3263
Reg. \$55.00

STOCK NO. CA-66

PAGING SPEAKER



Reg. Price \$42.00
OLSON PRICE
\$19.93

STOCK NO. S-317

WIDE ANGLE type. Weatherproof, indoor or outdoor. Can be used with Bogen or any amplifier. Complete with hermetically sealed 15 watt driver unit and mounting bracket. 8 ohm impedance. Size 7 1/2 h. x 14 w. x 12" d. Shipping wt. 8 lbs.

DUAL TRUMPET



Reg. Price \$38.00
OLSON PRICE
\$19.93

STOCK NO. S-318

WIDE ANGLE DUAL trumpet. Weatherproof for all indoor and outdoor use. Ideal for speech or music. Can be used with Bogen or any amplifier. Supplied less driver unit. Order unit No. S-176 below. One required. Size of bell mouth 18 1/2 x 9 1/4, depth 10 1/4. Shipping wt. 15 lbs.



OLSON PRICE
\$13.95
STOCK NO. S-176
DRIVER UNIT Reg. \$27.50
HERMETICALLY SEALED 25 WATT unit for above trumpet or any other trumpet. For speech and music. 16 ohm impedance. 60 watt peak. Heavy Alnico V magnet. Shipping wt. 5 lbs.

CRYSTAL MICROPHONE



Reg. Price \$14.95
OLSON PRICE
\$4.25

STOCK NO. M-105

High impedance. Ideal for Bogen or any other amplifier. Swivel tilting head. Response from 100 to 8000 cps. Attractive green finish with chrome trim. Standard thread fits any stand. 5 ft. shielded cable. Shipping wt. 3 lbs.

Microphone Stands



FLOOR STAND with 3 point collapsible base. Chrome and black. Shipping wt 10 lbs.

\$6.99 STOCK NO. M-94



DESK STAND chrome and black, for all microphones. Shipping wt. 3 lbs.

\$7.55 STOCK NO. M-95

NEWEST MODEL—SAVE MONEY

BOGEN-UNIVERSITY Mobile PA System

For ALL makes and models of cars, busses, and trucks.

SAVE ALMOST 50%
Reg. Price \$125.45
OLSON PRICE
\$63.74

6 VOLT MODEL—Stock No. AS-335
12 VOLT MODEL—Stock No. AS-336



Here's the answer to public address for Mobile use. Fits any make or model car, bus or truck. Ideal, compact, and easy to install. Universal mounting. Features include Beam Power Amplifier employing 2-6SF5, 1-6L6GA and 1-6X5GT tubes, remote control standby to reduce battery drain, fused power cable, calibrated volume control to 6 watts, gain 109 db., output 4.8 and 16 ohms. Size only 3 1/2 x 8 x 7. Choice of 6 or 12 volt models.

Speaker is the famous University IBS Trumpet Reflex with 15 watt driver unit and universal mounting bracket. 8 1/2" bell diameter x 9" long. Can be mounted inside or outside. Completely weatherproof.

Microphone is high-impedance crystal with satin chrome finish. Complete with attachments for use as a chest mike, for floor stand, or handheld.

Bus manufacturers note: up to 12 additional 4" or 5" ordinary cone type speakers can be also added and built into bus for passengers.

OLSON for COMBINATION DEALS

SAVE MORE! Order complete systems and save even more. Take your pick of any of these complete package deals, be assured of getting the finest equipment at the lowest prices.

AM-1 Amplifier, CA-66 Speakers and Case, M-105 Microphone, M-95 Table Stand. Stock No. AS-354... **\$94.30**

AM-1 Amplifier, Two S-317 Wide Angle Speakers, M-105 Microphone, M-95 Table Stand. Stock No. AS-355... **\$99.30**

AM-1 Amplifier, Two S-318 Dual Trumpets, Two S-176 Driver Units, M-105 Microphone, M-95 Table Stand. Stock No. AS-356... **\$128.50**

Send For FREE Olson Catalog



Send for your FREE copy today.

See and Hear . . . Every unit shown, plus the complete Bogen line is available at any one of our seven stores listed below. Come in soon and thrill to the tone of Bogen's new Amplifiers. Hear Tonal quality that defies description.

- AKRON 73 E. Mill St.
- CHICAGO 4101 N. Milwaukee Ave.
- CHICAGO 123 N. Western Ave.
- CLEVELAND 2020 Euclid Ave.
- PITTSBURGH 5918 Penn Ave.
- MILWAUKEE 423 W. Michigan
- BUFFALO 711 Main Street

IT'S EASY TO ORDER FROM OLSON'S

MAIL ORDERS TO AKRON, OHIO. How to order: Order directly from this ad. For convenience, use this order blank. Fill in columns below with quantity desired, stock number, description, and price. You may send remittance with order (include enough for postage or parcel post shipment), or if you prefer Send a \$2.00 deposit with your order and Olson will ship C.O.D. for the balance.

MONEY BACK GUARANTEE: Everything you order from Olson is guaranteed as advertised. If you are not more than satisfied, you may return merchandise for cash refund.

Quan.	Stock Number	DESCRIPTION	Price Each	TOTAL
-------	--------------	-------------	------------	-------

<i>1 Free Olson Catalog—</i>				

NAME	T-58	Total
ADDRESS		Add Postage
CITY	ZONE STATE	TOTAL AMOUNT

Olson Radio Warehouse

T-58 FORGE ST.
AKRON 8, OHIO

HQ for the 5 TOP QUALITY brands of

UBES

AT SENSIBLE PRICES!

• Individually Boxed • First Quality Only
WRITE FOR LATEST TUBE CATALOG FREE!
 We stock over 1000 types including Diodes, Transistors, transmitting and Special Purpose types.

Equipment & Component Specials

• Collins 2 Hy. @ 2 amp. Choke only 12 ohms—12,500 volt test. New, Orig. boxed—\$19.50

• Jennings Vacuum Variable Capacitor Type UCSX—Range approx. 20 to 700 MMFD. @ 10,000 volts. Complete with mounting brackets and drive gear—from new equipment. A beauty! Only \$36.95.

• Ideal Xfmr for dream KW Rig—Primary: 220 VAC—60 cycles—single phase. Secondary: 3200 VDC @ 350 ma. Has tapped secondary for numerous combinations of voltages. Shielded—very conservative ratings. Write for more complete info. Price \$27.50, prepaid free anywhere in U.S.A. Shipping weight 80 lbs.

• Little Gem Xfmr—Brand new compact. 19000 Ohms to 600 Ohms Plate to Line Xfmr, approx. 2" round x 2 1/4" high. Pri. rated at 10 mils. Can also be used as line to grid xfmr. Individually boxed. .69¢ each (10 for \$4.00).

• 6 Volt Vibrapack—New Unused. Delivers 300 Volts D.C. @ 100 ma. approx. (regular net over \$30.00) Special \$9.95

• NAVY SNOOPERSCOPE—Model RCA-US/C3 Professional equipment used as secret weapon in World War II. Lets you see in the dark. Complete with waterproof shoulder case and batteries for scope. U.S. Navy Surplus. New—\$125.00

• Prop-Pitch Motor—55 lbs. uncrated. New or like new, with brake removed and drive bar added. A real buy! Only \$34.50 F.O.B. New York or Atlanta.

• 28 volt—10 amp Xmfr—Pri: 115 vac/60 —\$4.50. (3 for \$12.00.)

• RCA Power Xmfr—1100 VCT at 250 Ma—6.4 volts at 8 amp.—5 v. at 3 amps. with 125 volt bias winding. Primary: 115 volts—60 cycles with taps. \$6.95.

• PEC 161 Battery Charger: Input 115 or 230 vac—40 to 60 cycles. 28 volts D. C. output at 35 amps. New, rack mounted, \$125.00.

• Collins Deluxe Filter Choke—6 hy. @ 400 ma. 70 ohms d.c.—10 kv. ins.—8"x5 1/2"x6" with porcelain terminals hermetically sealed—brand new; comm'l appearance, \$8.50 ea.; 3 for \$21.00.

• Deluxe 866A Filament Xmfr—New, boxed. Pri: 115-tapped 50/60 cycles—2.5 volts @ 10 amps. 12,000 volts test. Compact—Herm. sealed—\$3.95—Type T-2.

Ham TV Camera—See P. 28, May, 1957 "CQ" for conversion to 420 MC. TV also closed-circuit TV applications. Condition unused (some require outside case paint touch-up) w/all tubes incl. ICON. Model PH-522—only \$75.00

• Blower Motor—Squirrel cage type. 2 1/2" outside rotor diameter—Operates from 28 volts A.C. or D.C.—Hash filter and mtg. bracket included—From equipment. Lab. tested before shipment—\$2.85 each—2 for \$5.00.

2-COLOR TUBE CARTONS

Keeps your tube stock neat. New safety partition prevents tube breakage. Distinctively lithographed in glossy red and black. The most distinctive tube carton available today. Minimum quantity: 100 of any one size. Write for case lot prices. Packed 1000 to case. F.O.B. N. Y. C.

SIZE For Tube Per 100
 Miniature . . . 6AU6, etc. . . \$1.00
 GT . . . 6SN7GT, etc. . . 1.25
 Large GT . . . 1B3GT, etc. . . 1.50
 Large G . . . 5U4G, etc. . . 2.00



WHITE GLOSSY BOXES

Completely blank. No printing or color. Otherwise same as above. Same high quality at low prices. Specify "WHITE" when ordering. When color is not stated, 2 color cartons will be shipped.

• APN-9 Loran Sets—Excellent, used—\$169.50.

• Bud 77" Panel Space Relay Racks. Standard 19" amateur width—17" deep. Deluxe grey-crackle finish—loured side panels—top and bottom—back door with double lock—brand new in original wrappings—complete with hardware—shipped knocked-down—F.O.B. N. Y. area. An excellent buy at \$35.00.

TERMS: 25% deposit with order, balance C.O.D. All merchandise guaranteed for cost of merchandise only. F.O.B. N.Y.C.

Subject to price variation and stock depletion. We are near Prince St. BMT Station, Spring St. /IRT Station. Open Monday thru Saturday. Thousands of unadvertised specials. Come in and browse around.

BARRY ELECTRONICS CORP.

512 Broadway, Dept. RN, N.Y. 12, N.Y.
 Phone: WALKER 5-7000

an unknown resistance value is to be determined, the box is placed in the circuit under working conditions and the six knobs adjusted until best results are obtained, whereupon resistance value is read directly off the dials.

Many of the practical applications for this instrument are outlined in the new bulletin.

STANCOR REPLACEMENTS

Chicago Standard Transformer Corporation, 3501 W. Addison St., Chicago 18, Ill. has issued a one-page data sheet on three new flyback transformers designed as exact replacements for Philco part numbers 32-8624/1, 32-8465-2, 32-8509/-2, 32-8484-2, and 32-8695/-1.

Used in 22 different chassis and 130 model numbers, the Stancor HO-276, HO-277, and HO-278 units are described in some detail on the data sheet. A schematic and photograph of each unit is also included in Bulletin #537 which is available on request.

PRECISION POT DATA

Clarostat Mfg. Co., Inc., of Dover, N. H. has issued a precision potentiometer table designed to facilitate the selection of the correct unit for a given application.

In a 8 1/2"x11" page size to fit the data file or looseleaf binder, the table lists seven single-turn and one multi-turn type with dimensions, resistance values, tolerances, resolution, ratings, rotation, tandem groupings, torque, taps, weight, bearings, and other data.

G-E SOLDERING IRONS

General Electric Company, Schenectady 5, N. Y. has just issued an 8-page folder that describes and illustrates its complete line of soldering irons.

Features of the irons, including light weight, colorized and ironclad tips, and tubular heater are explained. Case histories of savings obtained by companies using the soldering irons are also included.

Those wishing a copy should specify Publication GED-3553. —50—

ARRL'S 10TH ANNIVERSARY CONVENTION

THE American Radio Relay League's 10th National Amateur Radio Convention is scheduled for August 15, 16, and 17 in Washington, D. C.

Headquarters will be the Sheraton-Park Hotel which is air-conditioned and provides a swimming pool and ample garage facilities. Special attention is being paid to the ladies, whether XYL's or licensed YL's. Events include a fashion show and sightseeing tours. A nursery will be available for children.

Inquiries concerning motels or other accommodations may be made to the Convention Housing Bureau, Greater National Capital Committee, 1616 K St., N. W., Washington, D. C. All who plan to attend should register as soon as possible. Pre-registration rates will be less than the registration rate at the convention. Further information is available from Federation of Radio Amateur Clubs, Inc., P. O. Box 3726, Washington 7, D. C. —50—

ORDER by MAIL and SAVE! TV PICTURE TUBES

10BP4	\$ 7.95	17BP4	\$10.95	21AMP4	\$19.95
12LP4	8.95	17CP4	17.00	21ATP4	20.95
14B/CP4	9.95	17GP4	17.60	21AUP4	20.95
16DP4	14.95	17HP4	13.60	21EP4	14.95
16EP4	15.90	17LP4	13.60	21FP4	15.95
16GP4	15.90	17QP4	11.95	21WP4	17.30
16KP4	10.95	17TP4	19.30	21YP4	15.95
16LP4	10.95	19AP4	19.30	21ZP4	14.95
16RP4	10.95	20CP4	13.90	24CP4	23.95
16WP4	15.20	20HP4	17.95	24DP4	26.95
16TP4	10.95	21AP4	22.10	27EP4	39.95
17AVP4	15.20	21ALP4	20.95	27RP4	39.95

27"—6 month guarantee—all others 1 year. Aluminized Tubes \$3.00 more than above prices. These prices are determined to include the return of an acceptable similar tube under vacuum.

ALL PRICES FOB CHICAGO, ILLINOIS. Deposit required, when old tube is not returned, refundable at time of return. 25% deposit required on COD shipments. Old tubes must be returned prepaid. We ship anywhere.

WRITE FOR COMPLETE LIST.

PICTURE TUBE OUTLET

3032 MILWAUKEE AVE.

CHICAGO 18, ILLINOIS

Dickens 2-2048

GET INTO ELECTRONICS



V.T.I. training leads to success as technicians, field engineers, specialists in communications, guided missiles, computers, radar and automation. Basic and advanced courses in theory and laboratory. Associate degree in electronics in 29 months. B.S. in electronic engineering obtainable. ECPD accredited. G.I. approved. Graduates in all branches of electronics with major companies. Start March, September. Dorms. campus. High School graduate or equivalent. Catalog.

VALPARAISO TECHNICAL INSTITUTE
 Dept. RD Valparaiso, Indiana

TAPE RECORDERS

WHOLESALE PRICES

HI-FI COMPONENTS

NATIONAL BRANDS

WRITE FOR FREE CATALOGUE

CARSTON

215-RD E. 88 ST.
 NEW YORK 28, N. Y.

WANTED!

Airborne Electronics

Collins
 Bendix
 Lear
 BC-348
 R540/ARN-14C
 BC-610E

WE PAY SWEET \$\$\$ FOR CLEAN GEAR!
 WHAT ELSE HAVE YOU? WRITE TODAY!

J. J. CANDEE CO. Dept. RN
 4002 W. Burbank Blvd., Burbank, Calif.
 Phone Victoria 9-2411

TOPS in the FIELD!

ELEMENTS OF MAGNETIC TAPE RECORDING by N. M. Haynes—Published by Prentice-Hall, Inc. The book that brings you up-to-date on tape recording. Complete history, theory, design. 392 Pages, 265 Illustrations, 5 1/2" x 9". Only \$7.95 at better book stores or get your autographed copy directly from author. Remit with order please. Book mailed same day. Order from:

AMPLIFIER CORP. of AMERICA 398 Broadway, New York 13, N. Y.

**Answer to Puzzle
appearing on page 125.**



PHOTO CREDITS

Page	Credit
35, 140.....	Blonder-Tongue Labs., Inc.
39 (top).....	"If All the Men in the World"
39 (bottom).....	Shannon Luminous Materials Co.
47.....	General Electric Co.
48.....	Nuclear-Chicago Corp.
57, 58, 59.....	RCA
65.....	Admiral Corp.
66.....	Sarkes Tarzian
68 (top).....	Standard Coil Products
68 (bottom).....	Packard-Bell
92.....	Automatic Electric Co.
95.....	Avion Div., ACF Industries
104.....	Heath Company
128.....	Sylvania Electric Products Inc.
130.....	Pacific Semiconductors
133.....	Westinghouse Mfg. Corp.
148.....	Allied Radio Corp.

**A Theatre Organ
for YOUR HOME!**

The Artisan simplified step-by-step assembly system with all mechanical and wood parts fully assembled lets you build a magnificent 2-manual and full pedal organ at a saving of up to 50%! No special skill needed!

the Artisan
ELECTRONIC ORGAN



Order Direct from

ELECTRONIC ORGAN ARTS, INC.
4878 EAGLE ROCK BLVD. DEPT. C25, LOS ANGELES 41, CALIF.



ALBUM

Only \$2.98

Hear the thrilling tones of the Artisan as played by prominent artists of the Theatre Organ. With explanatory notes.

PORTFOLIO of ORGAN FACTS jam-packed with vital information about organs. Only \$1.00

(LP Album and Portfolio - both for only \$3.49)

CLASSIFIED

RATE: 50¢ per word. Minimum 10 words. July Issue closes May 9th. Send order and remittance to: RADIO & TV NEWS, 1 Park Ave., N. Y. C. 16, N. Y.

RADIO ENGINEERING

ELECTRONICS! Associate degree—29 months. Technicians, field engineers, specialists in communications, missiles, computers, radar, automation. Start September, February. Valparaiso Technical Institute, Dept. N, Valparaiso, Indiana.

FOR SALE

DIAGRAMS for repairing radios \$1.00. Television \$2.00. Give make, model. Diagram Service, Box 672-RN, Hartford 1, Conn.

TUBES—TV, Radio, Transmitting And Industrial Types At Sensibly Low Prices. New, Guaranteed, 1st Quality, Top Name Brands Only. Write For Free Catalog or Call Walker 5-7000, Barry Electronics Corp., 512 Broadway, New York 12N, N. Y.

TELEVISION Sets \$11.95. Plus shipping. Jones TV, 147 High, Pottstown, Pa.

TUBES—Television, Radio, Guaranteed. Boxed, 75% off. Bell Electronics, 40 Canal, New York City 2.

RADIO & TV Tubes at manufacturers prices. Guaranteed—Send for free price list. Edison Electronic Tube Co., Menlo Park, N. J.

GOVERNMENT Sells—Surplus Electronics; Walkie-Talkies; Transceivers; Test Equipment; Oscilloscopes; Radar; Voltmeters; Misc.—Fraction of Army costs—Buy direct now from U. S. Government—"Depot List & Procedure" \$1.00—Brody, Box 8-RT, Sunnyside 4, New York.

FOR Sale: 6C21 Surplus @ \$8.00 each—2 for \$15.00. 2C26 Surplus @ \$3.00 each. 5B1P Surplus @ \$3.98 each—F.O.B. Olin Electronic Supply, 6009 Eastern Ave., Balto., 24, Md.

GOVERNMENT Surplus Snooperscopes, Radios, Mine Detectors, Parabolic Reflectors, Parts. Picture catalog 10¢. Meshna, Malden 48, Mass.

KITS—\$2.98 each. Resistance box, Tube checker, Capacitance box. Special! Order 2—get one free. Includes instructions, new parts, surplus case. Hi Voltage probe—29¢, 3 Alignment tools—29¢. New, used, surplus parts assortment—\$1.89. Allkit, Box 98, Midwood Station, Brooklyn 30, N. Y.

5KVA Variacs \$50; **6KVA Saturable Reactors** \$60; **600VDC 50 MFD Pyranol Condensers** \$5; **0.75KVA 115/230/460 V Single phase Transformers** \$7.50. Scientific Equipment, Box 2155, Oak Ridge, Tenn.

LABORATORY Oscilloscope New 5 MC direct from factory guaranteed. Kit price \$142. Write for free literature. Electronic Industries, Patterson, N. Y.

WANTED

LABORATORY Quality Equipment and Military Surplus Electronics bought, sold. Engineering Associates, 432 Patterson Road, Dayton 9, Ohio.

NOTICE

In replying to box numbers be sure to address letters to
RADIO & TV NEWS
1 Park Ave.
New York 16, N. Y.

Note: This does not apply to box numbers where city and state are shown

ART-13/T47A Transmitter \$100.00, **ART-13/T47 Transmitter** \$65.00, **BC-788C Altimeter** \$75.00, **R5/ARN-7 Radio Compass** \$60.00, **BC-348 Rec'r Unmod. Q & R Models** \$35.00, **ARC-1 Transmitter** \$90.00, **AN/ARN-14C Radio Receiver** \$250.00. Ship via express, C.O.D. Subject to Inspection to: H. Finnegan, 49 Washington Avenue, Little Ferry, New Jersey.

CYLINDER and old disc phonographs. Edison, Conqueror, Idelia, and Oratorio models. Berliner Gramophones and Zono-ophones, Columbia cylinder Graphophones, and coin-operated cylinder phones. Want old catalogues and literature on early phonos prior to 1919. Will pay cash or trade late hi-fi components. Classified Box 50 % Radio & TV News, 1 Park Ave., N. Y. C. 16, N. Y.

CASH Paid! Sell your surplus electronic tubes. Want unused, clean transmitting, special purpose, receiving, TV types, magnetrons, Klystrons, broadcast, etc. Also want military & commercial lab test and communications gear. We swap too, for tubes or choice equipment. Send specific details in first letter. For a fair deal write, wire or telephone: Barry, 512 Broadway, New York 12, N. Y. Walker 5-7000.

WANTED: Receiver R5/ARN-7, MN-62A Transceivers, RT18/ARC-1, AN/ARC-3, BC-788C, I-152C, Collins, Bendix equipment, Test Sets, Dynamotors, Inverters. We pay highest prices. Advise quantity, condition, price first letter. Aircraft Radio Industries, Inc., 70 East 45th St., N. Y. 17, telephone LEXington 2-6254.

HIGH FIDELITY

DISGUSTED with "HI" HI-FI Prices? Unusual Discounts On Your High Fidelity Requirements. Write. Key Electronics, 120 Liberty St., New York 6, N. Y. EVergreen 4-6071.

PRICES? Try ours! Everything in Hi-Fi. Factory sealed components. Write right now. Audion, 64-62 Booth St., Rego Park 74, N. Y.

DISCOVER our "Six Unique Services" on Hi-Fi; Stereo. Complete line. Write The Silver Trumpet, 406R Walnut, Alexandria, Indiana.

WHY Pay More! High Discount Hi-Fi Equipment. Write us your requirements. Stan-Burn, 558A Coney Island, Brooklyn 18, N. Y.

WORLD Renowned Hartley Speakers now available to Dealers, Servicemen, Custom Installers, lowest franchise requirements in high fidelity. Write Hartley Products Company, 521 East 162 Street, New York 51, N. Y.

SALES outlets wanted by speaker enclosure manufacturer and component supplier. Arc Electronics, 7219 South Fairfield, Chicago, Illinois.

TAPE & TAPE RECORDERS

TAPE Recorders, hi-fi components, tapes. Unusual Values. Free catalog. Dressner, 69-02 R, 174 St., Flushing 65, N. Y.

RECORDERS, HiFi, Tapes, Free Wholesale Catalog. Carston 215-R East 88 St., N. Y. C. 28.

TAPES—1200', \$1.25. 1800', \$1.65. Free catalog. Towers, #155, Philadelphia 5.

DISCOUNTS to 50%, recorders, tapes, hi-fi components, consoles, photograph equipment. Request specific prices only. Long Island Audio & Camera Exchange, 3 Bay 26th Street, Brooklyn 14-N, N. Y.

CORRESPONDENCE COURSES

USED Correspondence Courses and Books sold and rented. Money back guarantee. Catalog free. (Courses bought.) Lee Mountain, Pisgah, Ala.

INSTRUCTION

ENGINEERING Degrees, EE Option Electronics earned by home study. Residence classes also available. Pacific International University (operating as a college of engineering only at present), 5719-C Santa Monica Boulevard, Hollywood 38, California.

MISSILE Electronics: Learn basic circuits of transistors and magnetic amplifiers as used in Missiles and Satellites. Send \$1.00 for booklet. Kits also available. Box 8087, Long Beach 8, Calif.

MISCELLANEOUS

SAVE Money! Don't Buy until you get Our price list! All types Radio & TV tubes at Mfrs. prices! 100% Guaranteed! 24-Hour Service! Write United Radio Co., Newark, N. J.

TRADE-IN TV. Ship anywhere. \$9 up. Write Justis Bros., Newport, Del.

"TAB" Tubes Tested, Inspected, Boxed

Guaranteed FIRST-QUALITY Surplus
Postpaid Orders \$10 Receiving #'s 48 States

0A2	.80	6B16	.72	12AT6	.59	11Z7	.69
0B2	.72	6BK7	.99	12AT7	.89	11Z7G	1.10
0C3	.84	6BL7	1.19	12AU6	.63	4X4	2.00
0D3	.80	6BN6	1.08	12B7	.65	6CS1	2.65
0Z4	.50	6BQ6	1.19	12AX7	.79	2D21	.68
1A7	1.00	6BZ7	1.25	12BA6	.63	3D23	5.00
1B3	.71	6C4	.49	12CA7	.99	717A	5.75
1R5	.78	6C5	.69	12BD6	.59	4-125	29.00
1S4	.78	6C6	.80	12BE6	.59	4-250	35.00
1T4	.78	6CDB	1.49	12BF7	.99	4PR60	29.50
1U4	.68	6H6	.59	12BY7	1.00	4X150	19.00
1U5	.89	6J5	.59	12BZ7	.99	4X250	35.00
1X2A	.68	6J6	.59	12C6	1.45	4X500	38.00
3Q4	.68	6K6	.79	12CA7	.99	4X107	7.00
8Q5	.68	6L6	1.19	12SG7	.89	5BP4	1.98
3V4	.99	6S4	.59	12SH7	.89	5ST	4.00
5B4	1.25	6SA7	.69	12SK7	.75	250T	20.00
5V4	.89	6SB7	1.19	12SQ7	.69	288A	1.00
5Y2	.59	6SC7	.99	19B66	2.15	418A	14.00
6A4	.59	6SB7	.79	25G6	1.39	807	1.10
6AC7	.79	6SH7	.69	25G6	1.39	807	1.10
6A67	.89	6SJ7	.69	25L6	.72	808	1.00
6AH6	.89	6SK7	.69	25V4	.72	808	1.00
6B6	.68	6SL7	.89	25Z5	.72	100	10.00
6ALS	.59	6SN7	2/31	25Z6	.75	811	3.00
6A05	.66	6SQ7	.74	EL34	3.49	812	3.00
6A06	3.00	6SR7	.79	EL37	2.49	813	2.45
6AT6	.49	6T8	.98	5L16	.59	814	2.45
6A04	1.29	6U8	.98	35V4	.52	815	2.50
6A05	1.19	6V6	1.39	35Y4	.69	429B	8.00
6A06	.59	6W4	.69	50A5	.69	866A	1.60
6A04	.79	6W6	.89	50A5	.69	866A	1.60
6BA6	.59	6X4	.39	50B5	.69	6146	4.00
6BA7	1.00	6X5	.69	50C5	.69	6146	4.00
6B6	.69	6Y6	.89	50L6	.69	5881	2.70
6BE6	.59	7N7	.89	KT66	3.29	6550	3.90
6B6	1.50	7AL5	.75	80	.65	40	1.20
6BH6	.79	12AQ5	.75	80	.65	40	1.20

Write for Complete Tube List! Discounts to Qty. Buyers
TUBES WANTED! WE BUY! SELL & TRADE!

NEW "TEKSEL" SELENIUM BRIDGE RECTIFIERS. ONE YEAR GTD!
FULL WAVE BRIDGE • WRITE FOR CATALOG

CURR.	18VAC	36VAC	72VAC	144VAC
CONTR.	14VDC	28VDC	56VDC	112VDC
1AMP	\$ 1.30	\$ 2.00	\$ 4.20	\$ 9.45
2AMP	2.15	3.00	6.45	12.30
3AMP	3.30	4.00	8.65	16.75
6AMP	4.15	8.00	16.75	36.15
10AMP	6.10	12.15	28.30	48.90
15AMP	9.30	19.00	40.00	65.40
24AMP	15.00	29.45	57.50	108.45



NEW GTD RADIO & T.V. RECTIFIERS

35MA	40c @ .6 for 52; 65MA	45c @ .5 for 52; 75MA	49c @ .5 for 52; 100MA	59c @ .6 for 53; 150MA	70c @ .8 for 55; 250MA	79c @ .6 for 54; 300MA	89c @ .5 for 54; 350MA	\$1.00 @ .8 for 57; 400MA	\$1.10 @ .5 for 55; 500MA	\$1.35 @ .4 for 55; 65MA/260V	\$1.10 @ .5 for 55; 100MA/260V	\$1.25 @ .9/510; 100MA/156V	95c @ .300MA/156V
------	-----------------------	-----------------------	------------------------	------------------------	------------------------	------------------------	------------------------	---------------------------	---------------------------	-------------------------------	--------------------------------	-----------------------------	-------------------

New Silicon 500MA/Hi Temps/140V Rectifier H/m Sealed with clip... \$1.55 @ .7 for \$10, 25 for \$33 MFGRS. & DSTRBTRS., WRITE FOR QTY. PRICES.

HAMS NEW TRANSISTORIZED "TABPAK"
 12 VDC to HI VDC POWER SUPPLY!!!!
 Kit or Assembled. Filtered, small in size! Quiet! Light Wgt. Input 12 to 14VDC (Low Idle Current). Output 450k Ω at 250VDC at up to 150ma/65 watts. Int. "TABPAK" Assembled TR39CB. \$35 "TABPAK" Kit TR39CK. \$30

DIAMOND PHONO-NEEDLES Postpaid 48 States!
 REGISTERED ONE YR. GUARANTEED BY THE MFGR!
 ALL MAKES LP&78-ONE DIAMOND \$7
 TWO DIAMONDS \$14; DIAMOND & SAPPHIRE \$8
 PLEASE SEND CARTRIDGE NAME & NUMBER

NEW VRII "GE" PHONO CARTRIDGES!!
 Postpaid 48 States!

4G061/LP or 4G063/78 DIAMOND	\$16
4G050/LP&78 TRI-PLAY DIAMOND	\$19.59
4G052/LP&78 TRI-PLAY DIAMOND & SAP.	\$18
4G053/LP&78 TRI-PLAY DIAMONDS	\$26

NEWEST IMPROVED HI-FI SPEAKERS!
 With Inbuilt Network Ticonal Alnico 5 Plus Magnet 4 to 8 ohms V.C.
 NOW NEW IMPROVED HEAVY DUTY
 12" 3-WAY, 18,000 Cycles.
 MODEL F12H3X. Wgt. 10 lbs. \$38
 12" COAX. 20 Watt/45-13,000 Cys. \$27
 6"/25 Watt Midrange 300-6000 Cys. \$24
 Electrostatic Tweeter & dca \$3.25 @ .2/56

FINEST HI-FI RECORDING TAPE
 1200 Ft.—7" Reel **\$1.45** Lots of 3
 Money Back Gtd.
 Highest quality controlled plastic base tape made by new Erin process. Precision coated & slit. Std. 15 IPS output. Splice Free. Freq. 7 1/2 IPS 40-15KC Oxide Wnd In.
 New 1st Quality "Mylar" 2400 Ft.—7" Reel Ferro Erin Gloss Process Recording tape. \$4.49, 3 for \$12

DC POWER FOR TRANSISTORS!!
 Transistor! Filtered Power Supply Kit used to power transistor circuits, amplifiers, etc. Delivers 12VDC at 2AMPS filtered less than 0.5% ripple or 28VDC at 1A TPSR Kit \$18; TPS2W assembled & wired \$24.
 115VAC Inpt Transformer & Full Wave Bridge Rectifier for 12VDC @ 2AMPS or RECTRAN KIT RT1K. \$4.50
 RT1W Assembled & Wired. \$8.50
 RT2K Kit 12 or 18VDC at 6 AMPS. \$19.00
 RT2W Assembled & Wired. \$14.75

KITS! "TAB" THE BEST KITS!

All Kits Contain Most	Popular Values & Sizes
Kit 35 Precision Resistors	Kit 35 Power Resistors
Kit 18 Switches	Kit 75 Mica Cond's
Kit 3 Transistor Transf.	Kit 6 Crystal Diodes
Kit 150 Carbon Resistors	Kit 8x25 ft. Hookup Wire
Kit 42 Panel Lamps	Kit 100 Fuses
Kit 12 Electrolytic Cond's	Kit 100 Ceramic Cond
Kit 15 Volume Controls	Kit 18 Rotary Switches
Kit 36 Tube Sockets	Kit 6 Crystals & Holders
Kit 50 Tubular Cond's	Kit 65 Inductors & Coils
Kit 500 Lugs & Eyelets	Kit 6 Microphones
Kit 10 Xmit Mica Cond's	Kit 10 Wheat Lamps
Kit 5 Lbs. Surprise Kit	Kit 40 Insulators
Kit 10 Xmit Mica Cond's	Kit 85 Insulated Resist.
Kit Encapsulation Fluid	Kit TV Knobs
Kit Volume Control Fluid	Kit Glyptal Cement & Varnish

"TAB" TERMS: Money Back Guarantee! Our 14th year. \$2 min. order. F.O.B. N.Y.C. Add shpg charges or for C.O.D. 25% Dep. Prices subject to change.
 111HR LIBERTY ST., N. Y. 6, N. Y. Catalog
 Write for PHONE: RECTOR 2-6245

INDEX OF Advertisers

MAY 1958

While every precaution is taken to insure accuracy, we cannot guarantee against the possibility of an occasional change or omission in the preparation of this index.

ADVERTISER	PAGE	ADVERTISER	PAGE
Acro Products Company	128	McNeal Electric & Equipment Company	134
Advance Electronics	154	M. R. Company	153
Airex Radio Corp.	124	Mallory & Co., Inc., P. R.	Fourth Cover
Allied Radio Corp.	9, 107, 108, 109, 110, 111, 112, 113, 114	Marantz Company	104
Altec Lansing Corporation	24	Merit Coil & Transformer Corp.	28
American Concertone	125	Michigan Magnetics, Inc.	100
American Television & Radio Co.	130	Milwaukee School of Engineering	140
Amperex Electronic Corp.	86	Minnesota Mining and Manufacturing Company	139
Amplifier Corp. of America	160	Moss Electronic Distributing Co., Inc.	96, 97
Arrow Sales, Inc.	124	Multicore Sales Corporation	94
Ash Radio Co., Walter	157	National Radio Institute	3, 7
B & K Manufacturing Co.	69	National Schools	23
Baltimore Technical Institute	153	Neshaminy Electronic Corp.	90
Barry Electronics Corp.	160	Newark Electric Company	155
Bell Telephone Laboratories	10	North American Phillips Co., Inc.	87, 88
Blonder-Tongue Labs., Inc.	95	Northrop Aeronautical Institute	94
Bozak Sales Company, The R. T.	128	Nuclear-Electronics Corporation	135
British Industries Corporation	30	Oelrich Publications, Inc.	135
Brooks Radio & TV Corp.	139, 148	Olson Radio Warehouse	159
CBS-Hytron	17, 106	Oxford Components, Inc.	147
C & H Sales Co.	134	Pacific International University	146
Cagan Sales, R. C.	146	PACO Electronics Co., Inc.	18
Candee Co., J. J.	160	Peak Electronics Company	122
Candler System Co.	146	Picture Tube Outfit	160
Capitol Radio Engineering Institute	29, 91	Pilot Radio Corporation	130
Carston	160	Platt Electronics Corporation	144
Century Electronics Co., Inc.	121	Popular Photography Directory	120
Champion DeArment Tool Company	98	Precision Electronics	101
Channel Master Corp.	25	Progressive "Edu-Kits" Inc.	143
Cleveland Institute of Radio Electronics	13	Quality-Electronics	146
Columbia Electronics	156	RCA Institutes, Inc.	11
Cornell-Dubilier Electric Corp.	26	RW Electronics	157
Coyne Electrical School	136, 145, 155	Radio Corporation of America	22, 89, 129
Cutick Electronics	134	Radio-Electronic Master, The	141
Delco Radio	12	Radio & Electronic Surplus	154
DeVry Technical Institute	5	Radio Shack Corporation	99
Dressner	147	Rad-Tel Tube Co.	149
Dynaco, Inc.	102	Raytheon Manufacturing Company	Second Cover
EBE, Inc.	153	Recoton Corporation	127
Edmund Scientific Co.	141	Rex Radio Supply Company	94
EICO	33, 34	Rider Publisher Inc., John F.	153
Electro-Voice, Inc.	15	Rinehart & Co., Inc.	146, 157
Electronic Chemical Corp.	136	Sams & Co., Inc., Howard W.	19, 141, 153
Electronic Experimenter's Handbook	118	Service Instrument Corp.	151
Electronic Measurements Corp.	150	Sonotone Corporation	103
Electronic Organ Arts, Inc.	161	Sparks Radio Supply	143
Fair Radio Sales	131	Spaulding Products Company, Inc.	152
Filnor Products, Inc.	127	Sprayberry Academy of Radio-Television	27
G & G Radio Supply Co.	123	Stan-Burn Radio & Electronics Co.	156
General Electric	20, 21	Standard Line Electric Company	145
General Motors Corp.	32	Supreme Publications	151
Glaser-Steers Corp.	126	"TAB"	162
Goodheart, R. E.	153	Telemarine Communications Co., Inc.	137
Grantham Schools	120	Telephone Engineering Co.	147
Greenlee Tool Co.	124	Tele-Vue Towers	115
Harvey Radio Company, Inc.	14	Terado Company	134
Heath Company	70, 71, 72, 73, 74, 75, 76, 77, 78, 79, 80, 81, 82, 83, 84, 85	Texas Crystals	158
Henshaw Radio Supply	135	Tope Deutchmann Corporation	132, 133
Hi-Fi Guide and Yearbook	154	Transvision, Inc.	156
Indiana Technical College	146	Triad Transformer Corporation	142
Jerrold Electronics Corporation	16	Triplett Electrical Instrument Corporation	Third Cover
Jones Binder, Jesse	143	Tri-State College	135
Lafayette Radio	116, 117	Tung-Sol Electric Co.	8
Lampkin Laboratories, Inc.	90	University Loudspeakers, Inc.	6
Lektron	136	Valparaiso Technical Institute	160
McGee Radio Company	105	Van Norman Industries, Inc.	149
MACMILLAN COMPANY, The	138	Video Electric Company	119
		World Radio Laboratories	155

triple news from triplett

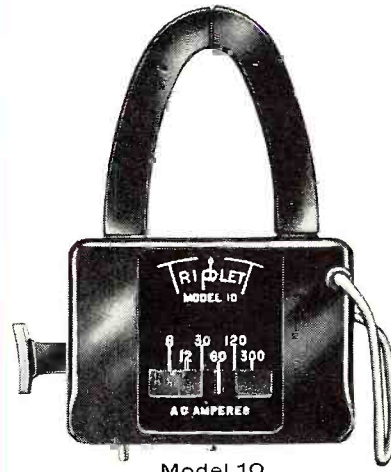

Model 10

Here is a real value—much more value than in any other clamp-on ammeter. Remember, in Triplet Model 100 you get not only a clamp-on ammeter but a genuine Triplet complete Volt-Ohm-Milliammeter with which you can measure AC volts, DC volts, AC and DC current, and Ohms.

BURTON BROWNE ADVERTISING

1st news: Triplet Model 10 Clamp-On Adapter

Just plug into any Triplet Model 310 Miniature VOM it becomes an AC clamp-on ammeter to measure AC amperes without cutting or opening current carrying wires. The split transformer yoke opens at the touch of a lever to fit around a single conductor or bus-bar for direct readings of AC amperes from 6 to 300 in 6 steps. Model 10 \$14.50 net.

The Model 10 can be separated from the Model 310 as shown in the drawing at left by No. 311 lead attachment. This permits readings in difficult locations. No. 311 leads \$1.90 net.

2nd news: Triplet Model 101 Line Separator

Serves to plug in at outlet to divide 2 conductor cords for clamp-on measuring. Makes accurate, rapid-testing of radio and TV sets, phonographs, appliances, motors, etc. possible without opening or splitting double conductors. Also serves to increase ammeter sensitivity 10X and 20X, if desirable, for easier reading. Model 101 \$5.50 net.

3rd news: All four parts are available conveniently packaged in one handy, durable, high-quality carrying case. This complete package is known as Triplet Model 100 and is priced at \$61.90 net.

Model 100 consists of Model 310 VOM, Model 10 Clamp-On Adapter, Model 101 Line Separator, No. 311 leads and carrying case with provision for all parts.

Triplet Electrical
Instrument Company
Bluffton, Ohio

53 years of experience

In addition, to use with the Model 310, the Model 10 Adapter also can be used as a Clamp-On Ammeter with any Volt-Ohm-Milliammeter having a 3 AC volt scale at 5000 Ohms per volt such as Triplet Models 630, 630-A, 630-NA, 631, etc., by employing Triplet No. 611 leads, \$1.90 net.

Triplet Model 100 gives you the world's most flexible test equipment for all electrical and electronic applications.



631



630-NA



630



630-A



310



630-T



666-HH



625-NA



666-R



3 Million Transistor Portables

*Mean Big Battery Business
and Bigger Dealer Profits*

That's a lot of transistor portables that are going to be needing batteries this year . . . nearly three times as many as a year ago, and the figure is still growing.

For this skyrocketing new market, Mallory offers a complete line of transistor and portable radio batteries.

Mercury batteries, pioneered by Mallory, last longer, give steadier volume than ordinary batteries. Mallory Zinc-Carbon batteries are dependable and economical—meet all the requirements of today's modern portable radio sets, and flashlights as well.

Mallory Battery Company

A Division of



In Canada, Mallory
Battery Company of
Canada Limited,
Toronto 4, Ontario

P. R. MALLORY & CO. Inc., INDIANAPOLIS 6, INDIANA

- Capacitors • Vibrators • Resistors • Controls • Switches • Filters
- Rectifiers • Power Supplies • Mercury and Zinc-Carbon Batteries